

VIRGO S70

Design by: Manuel Vivian

MASIERO



Struttura in poliuretano espanso e metallo verniciato. Illuminazione LED diretta e indiretta.

Frame made of expanded polyurethane foam and painted metal. Direct and indirect LED lighting system.

Struktur aus Polyurethanschaumstoff und lackiertem Metall. Direkte und indirekte LED-Beleuchtung.

Structure en polyuréthane expansé et en métal verni. Éclairage direct et indirect avec LEDs.

Конструкция из вспененного полиуретана и окрашенного металла. Светодиодное прямое и не прямое освещение.



H 9 cm / 3.54"
Ø 67 cm / 26.37"

UP LED x 19 W CRI>80
3000 K - 1248 lm

DOWN LED x 22,8 W CRI>80
3000 K - 3000 lm

Dimmable: ONLY DOWN
1-10V + PUSH

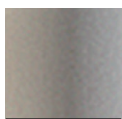
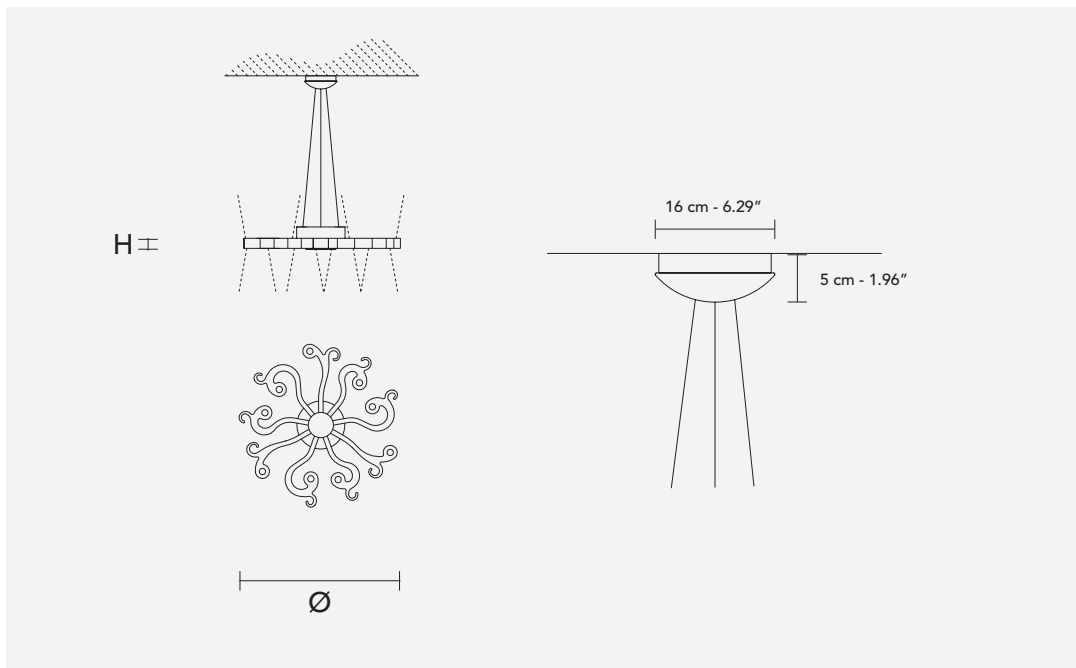

WH-M