



Una lavorazione unica, tipica di Venezia, pasta di vetro e pasta di smalti plasmati nelle storiche vetrerie Muranesi in bastoncini dai riflessi e perle di varie dimensioni e colori. Con le creazioni della linea Venezia, Patrizia Volpato ha saputo riscoprire vecchie tradizioni e piacevoli atmosfere da proporre con piacere ai suoi clienti./

A unique method of craftsmanship, typical of Venice, with molten glass and molten glaze shaped in the historic Murano glassworks into rods with reflections and pearls of different sizes and colours. With the creations of the Venice range, Patrizia Volpato has managed to rediscover old traditions and pleasant atmospheres that she is pleased to offer to her clients.

Codice / Code **4805/S150**

Tipo / Type **Sospensione / Hanging lamp**

Vetro / Glass

*Frangia: arte antica del vetro veneziano
lavorazione a mano*
*Fringe: ancient venetian glass art
handmade*

Colori Disponibili / Available Colors



Trasparente / Clear



Ambra / Amber

Finiture Disponibili / Available Finishes



Grigio spazzolato / Brushed grey



Tortora / Dove grey



Brunito spazzolato / Burnished brass

Tipo di luce / Light Source

30xG9 alogena risparmio energetico o 30xG9 LED

30xG9 halogen energy saver or 30xG9 LED bulbs



Punti di fissaggio staffa /
Bracket fixing points

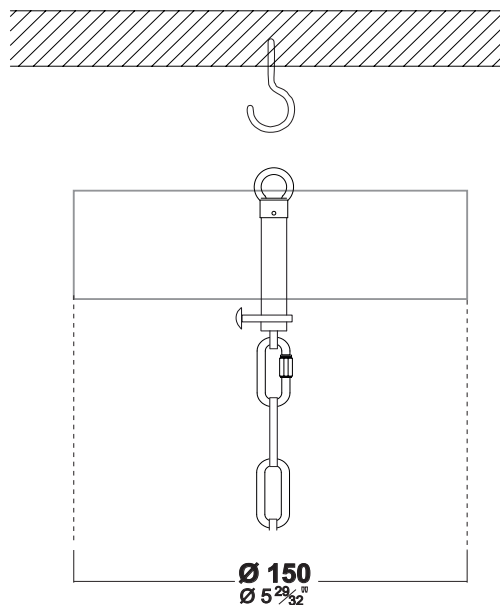

Codice / Code **4805/S150**

Tipo / Type **Sospensione / Hanging lamp**

Dimensioni / Dimensions

Ø 150 - H 85-149 cm
Ø 59.06 - H 33.46-58.66 in

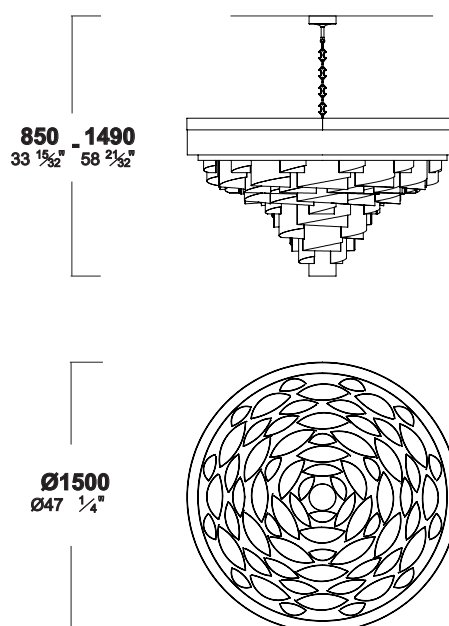

Peso e Volume / Weight and Volume

KG 85,00 kg / 187.39 lb

m³ 0,958 m³ / 33.831 ft³

Per la legenda dei simboli visitare il sito .
For the symbols key visit the website.
Pour la clé des symboles visitez le site Web.
Für die Zeichenerklärung Besuchen Sie die Website.
Para la clave de los símbolos visitar la página web.
Чтобы найти ключ к символам - посетите сайт .