



Qualità, eleganza e semplicità, sono le basi per questa fantasia di proposte; I singoli paralumi, le semplici forme in metallo, le ricercate trasparenze dei vetri e i riflessi delle cannule, i legni appositamente scelti, il gioco di ombre e luci...tutto concorre per offrire la bellezza della luce avvolta in piacevoli dimensioni. /

Quality, elegance and simplicity are the basis for these original range of offerings; the particular lampshades, the simple metal shapes, the sophisticated transparencies of the glasses and the reflections of the cannulas, the carefully-chosen wood, the play of lights and shadows... they all are elements that, together, create the beauty of the light wrapped in pleasant dimensions.



Codice / Code **310/S55**

Tipo / Type **Sospensione / Hanging lamp**

Finiture Disponibili / Finishes Available

-  *Bianco opaco / Matt white*
-  *Rame scuro / Dark copper*
-  *Nichel nero / Black nickel*

Paralumi disponibili / Available shades

-  *Grigio antracite 0395 / Charcoal grey 0395*
-  *Grigio cemento 0414 / Concrete grey 0414*

Tipo di luce / Light Source

*3xE27 (US E26) alogena risparmio energetico o
3xE27 (US E26) LED*

*3xE27 (US E26) halogen energy saver or
3xE27 (US E26) LED bulbs*



Punti di fissaggio staffa /
Bracket fixing points

Codice / Code **310/S55**

Tipo / Type **Sospensione / Hanging lamp**

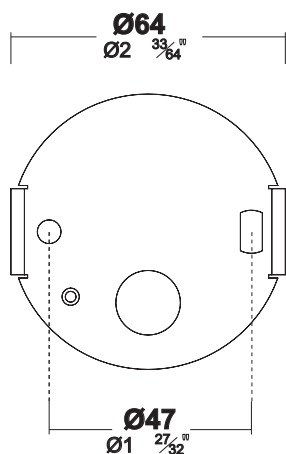

Dimensioni / Dimensions

$\text{Ø} 55 - H 56,5-175,5 \text{ cm}$
 $\text{Ø} 21.45 - H 22.04-68.45 \text{ in}$

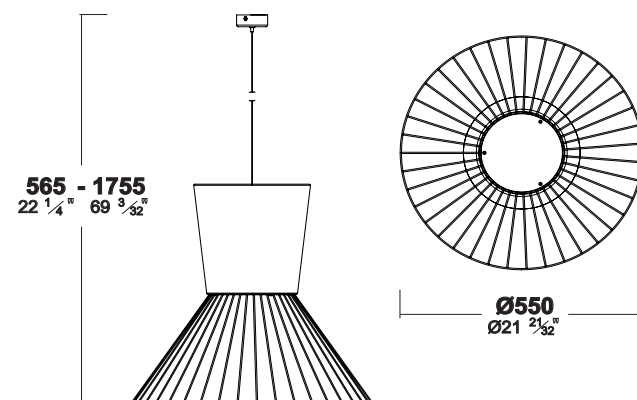

Peso e Volume / Weight and Volume



7,50 kg / 16.534 lb



0,419 m³ / 14.795 ft³

CE

Per la legenda dei simboli visitare il sito .
For the symbols key visit the website.
Pour la clé des symboles visitez le site Web.
Für die Zeichenerklärung Besuchen Sie die Website.
Para la clave de los símbolos visitar la página web.
Чтобы найти ключ к символам - посетите сайт .

Con lampadine dimmerabili
With dimmable bulbs

Patrizia Volpato - Via Del Trifoglio, n° 15 30175 Marghera (Ve) Italia Tel. +39 041 932857
Fax +39 041 923006 info@patriziavolpato.it www.patriziavolpato.it P.I. 02711630273