

Magdalena, Cutting edge *Beauty.*

design Bruno Rainaldi
terzani.com



Type |
Suspension

Materials |
Metal

Finishes | Code

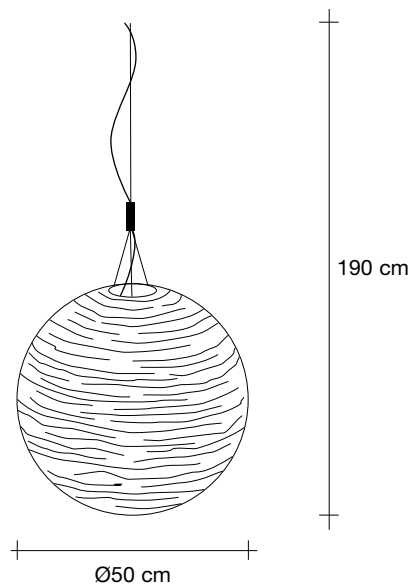

-  White
OM61S E8 C8
-  Nickel
OM61S G8 C8
-  Gold leaf
OM61S H5 C8

Body |



Recommended Light | Canopy |

230-240V ~ 50/60Hz

-  LED
15W E27
-  Dimmable with
all systems

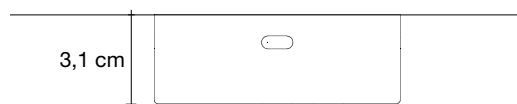
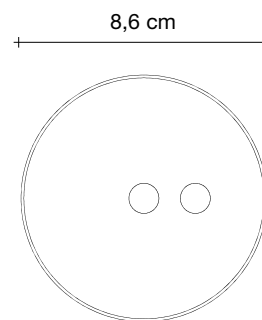

Reaching inside traditional forms, Magdalena's laser-cut, horizontal openings allow for its light to expand its range to the entire room. Creating an alluring pattern of light and shadow, Magdalena highlights the shape of the room itself. This unique exchange creates a pendant that impacts every space, regardless of size. Design Bruno Rainaldi.



12,5



6



60cm x 60cm x 60cm

Magdalena, Cutting edge *Beauty.*

design Bruno Rainaldi
terzani.com



Type |
Suspension

Materials |
Metal

Finishes | Code

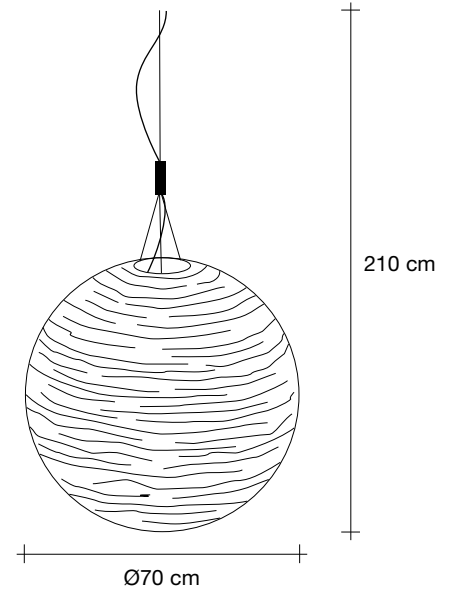

-  White
OM62S E8 C8
-  Nickel
OM62S G8 C8
-  Gold leaf
OM62S H5 C8

Body |



Recommended Light | Canopy |

230-240V ~ 50/60Hz

-  LED
15W E27
-  Dimmable with
all systems

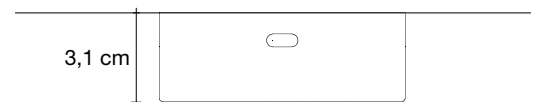
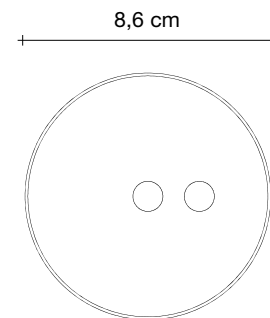

Reaching inside traditional forms, Magdalena's laser-cut, horizontal openings allow for its light to expand its range to the entire room. Creating an alluring pattern of light and shadow, Magdalena highlights the shape of the room itself. This unique exchange creates a pendant that impacts every space, regardless of size. Design Bruno Rainaldi.



23



13



76cm x 76cm x 60cm



Magdalena, Cutting edge *Beauty.*

design Bruno Rainaldi
terzani.com



Type |
Suspension
Materials |
Metal



Finishes | Code

-  White
OM65S E8 C8
-  Nickel
OM65S G8 C8
-  Gold leaf
OM65S H5 C8

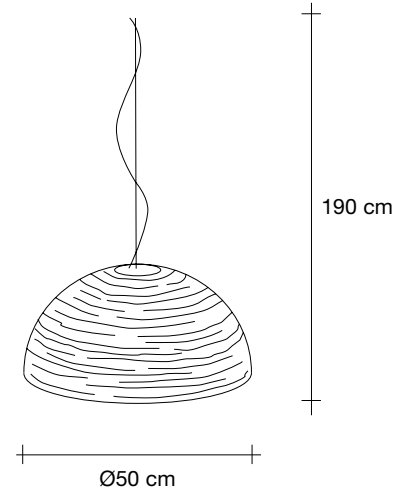
Body |



Recommended Light | Canopy |
230-240V ~ 50/60Hz

-  LED
8W E27
-  Dimmable with
all systems

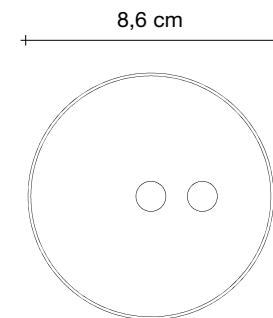

Reaching inside traditional forms, Magdalena's laser-cut, horizontal openings allow for its light to expand its range to the entire room. Creating an alluring pattern of light and shadow, Magdalena highlights the shape of the room itself. This unique exchange creates a pendant that impacts every space, regardless of size. Design Bruno Rainaldi.

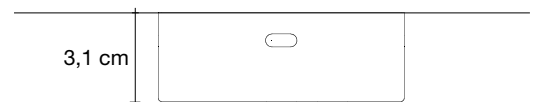

8,5



3,7



60cm x 60cm x 60cm

Magdalena, Cutting edge *Beauty.*

design Bruno Rainaldi
terzani.com



Body |



Type |
Suspension
Materials |
Metal

Finishes | Code

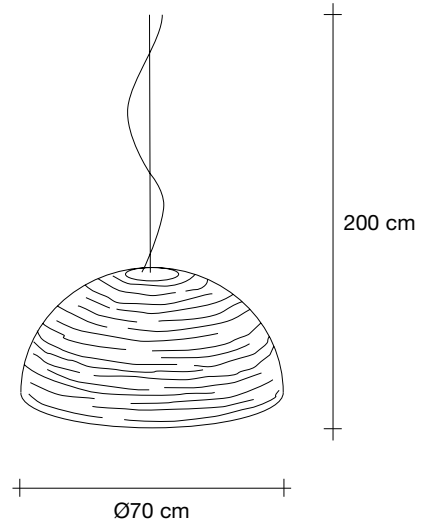
-  White
OM66S E8 C8
-  Nickel
OM66S G8 C8
-  Gold leaf
OM66S H5 C8



Recommended Light | Canopy |
230-240V ~ 50/60Hz

-  LED
8W E27
-  Dimmable with
all systems

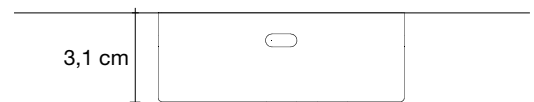
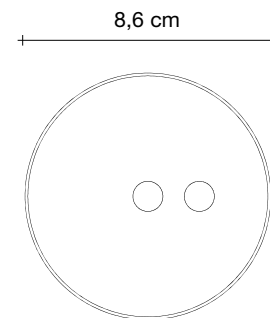

Reaching inside traditional forms, Magdalena's laser-cut, horizontal openings allow for its light to expand its range to the entire room. Creating an alluring pattern of light and shadow, Magdalena highlights the shape of the room itself. This unique exchange creates a pendant that impacts every space, regardless of size. Design Bruno Rainaldi.



15



8



76cm x 76cm x 60cm