

HANGING LAMP COLGANTE



MATERIAL: Opal glass and brass

MATERIAL: Vidrio opal y latón

LED
E14 7W x 5 units

WEIGHT PESO: 10 KG
Package size: 0,72 x 0,72 x 0,72

FINISHES
ACABADOS

LAQUERED
LACADOS



BLACK
NEGRO



WHITE
BLANCO



SLATE BLUE
AZUL PIZARRA

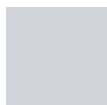

FOG BLUE
AZUL NIEBLA



GREY GREEN
VERDE GRIS



SOFT GREEN
VERDE SOFT



BURGUNDY
BORGOÑA



CORAL PINK
ROSA CORAL



PASTEL BLUE
AZUL PASTEL

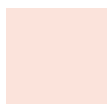

QUARTZ PINK
ROSA QUARZO

FABRIC LAMPSHADE (OPTIONAL)
PANTALLAS TEXTILES (OPCIONAL)



BLACK
NEGRO



RED
ROJO



WHITE
BLANCO

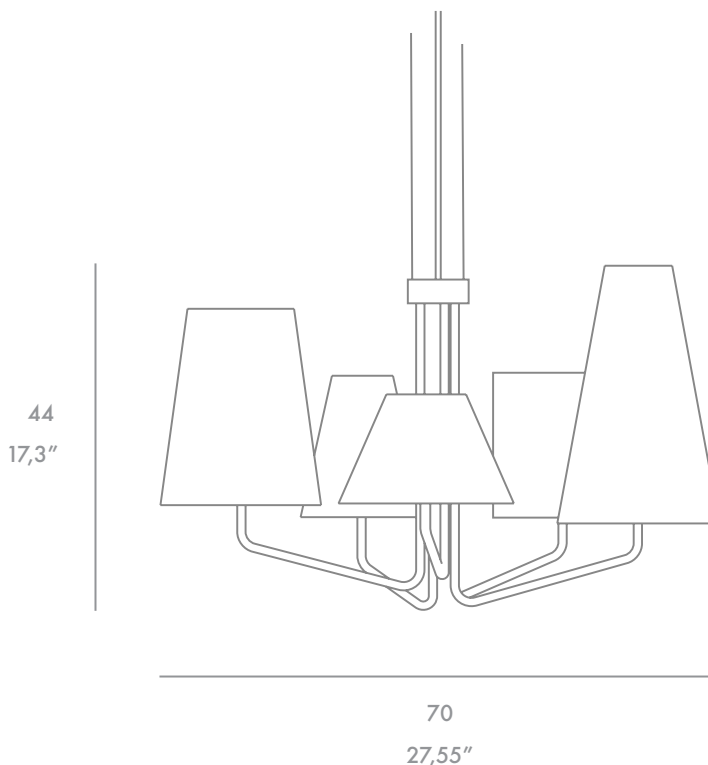

Lighting for domestic use.

Do not store or keep under extreme temperatures during long periods of time.

Do not handle the electrical material more than the necessary for installation of the fixture.

The installation must be done by specialized technical team.

Do not use bulbs with superior voltage as recommended by the manufacture.

For its cleaning, use only a soft cloth moistened with a mild soap solution. Do not use ammonia products, solvents or abrasives.

Do not use products such as air freshener that may contain alcoholic base.

Iluminación para uso doméstico.

No almacenar ni exponer a condiciones extremas de humedad o durante periodos prolongados.

No manipular el material eléctrico de la luminaria más allá del especificado para su montaje.

La instalación debe realizarse por personal técnico especializado.

No utilizar bombillas de potencia superior a la recomendada por el fabricante.

Para su limpieza, utilizar un paño suave ligeramente humedecido con una solución jabonosa.

No utilizar productos amoniacales, disolventes ni abrasivos. No pulverizar directamente, ni arrojar sobre la superficie productos ambientales y/o de base alcohólica.



HANGING LAMP COLGANTE

MATERIAL: Brass

MATERIAL: Latón

LED
E14 7W x 7 units

WEIGHT PESO: 20 KG
Package size: 1,14 x 1,14 x 0,73

FINISHES
ACABADOS

LAQUERED
LACADOS



BLACK
NEGRO



WHITE
BLANCO



SLATE BLUE
AZUL PIZARRA

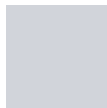

FOG BLUE
AZUL NIEBLA



GREY GREEN
VERDE GRIS



SOFT GREEN
VERDE SOFT



BURGUNDY
BORGOÑA



CORAL PINK
ROSA CORAL



PASTEL BLUE
AZUL PASTEL



QUARTZ PINK
ROSA QUARZO

FABRIC LAMP SHADE (OPTIONAL)
PANTALLAS TEXTILES (OPCIONAL)



BLACK
NEGRO



RED
ROJO



WHITE
BLANCO

54
21,3"

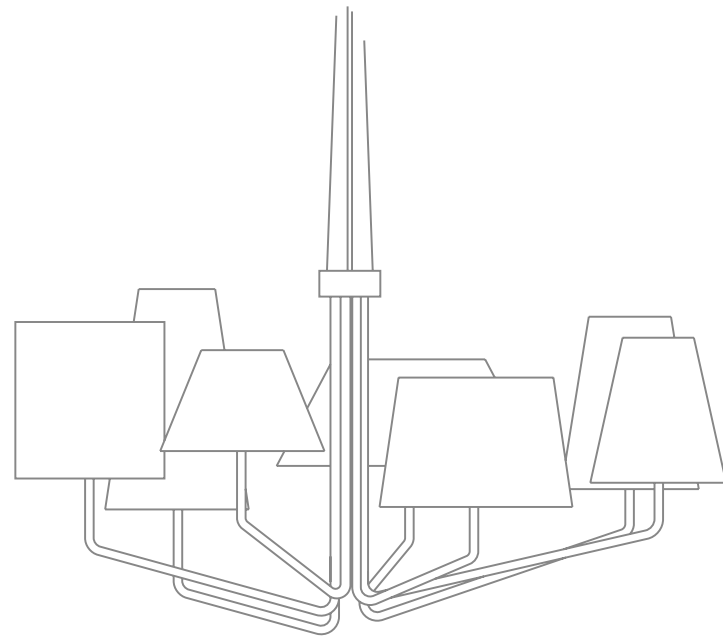

115
45,3"

Lighting for domestic use.

Do not store or keep under extreme temperatures during long periods of time.

Do not handle the electrical material more than the necessary for installation of the fixture.

The installation must be done by specialized technical team.

Do not use bulbs with superior voltage as recommended by the manufacture.

For its cleaning, use only a soft cloth moistened with a mild soap solution. Do not use ammonia products, solvents or abrasives.

Do not use products such as air freshener that may contain alcoholic base.

Iluminación para uso doméstico.

No almacenar ni exponer a condiciones extremas de humedad o durante periodos prolongados.

No manipular el material eléctrico de la luminaria más allá del especificado para su montaje.

La instalación debe realizarse por personal técnico especializado.

No utilizar bombillas de potencia superior a la recomendada por el fabricante.

Para su limpieza, utilizar un paño suave ligeramente humedecido con una solución jabonosa.

No utilizar productos amoniacales, disolventes ni abrasivos. No pulverizar directamente, ni arrojar sobre la superficie productos ambientales y/o de base alcohólica.



TABLE LAMP SOBREMESA

MATERIAL: Brass

MATERIAL: Latón

LED
E14 4W x 4 units

WEIGHT PESO: 3 KG
Package size: 0,85 x 0,46 x 0,46

FINISHES
ACABADOS

LAQUERED
LACADOS



BLACK
NEGRO



WHITE
BLANCO



SLATE BLUE
AZUL PIZARRA

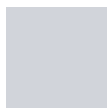

FOG BLUE
AZUL NIEBLA



GREY GREEN
VERDE GRIS



SOFT GREEN
VERDE SOFT



BURGUNDY
BORGOÑA



CORAL PINK
ROSA CORAL



PASTEL BLUE
AZUL PASTEL

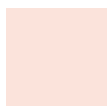

QUARTZ PINK
ROSA QUARZO

METALLIC
METÁLICOS



CHROME
CROMADO



COPPER
COBRE



GOLD
ORO

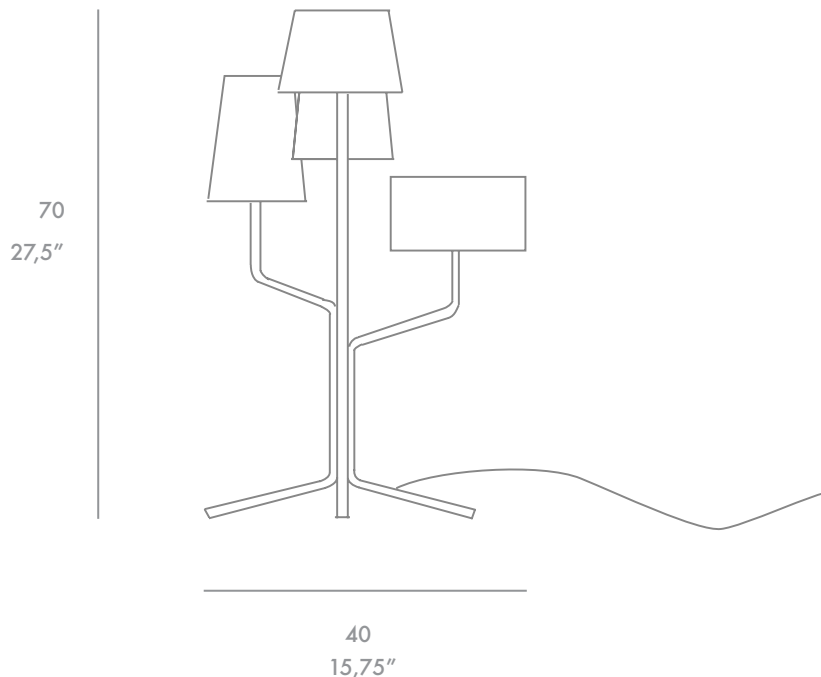

FABRIC LAMPSHADE (OPTIONAL)
PANTALLAS TEXTILES (OPCIONAL)



BLACK
NEGRO



RED
ROJO



WHITE
BLANCO

Lighting for domestic use.

Do not store or keep under extreme temperatures during long periods of time.

Do not handle the electrical material more than the necessary for installation of the fixture.

The installation must be done by specialized technical team.

Do not use bulbs with superior voltage as recommended by the manufacture.

For its cleaning, use only a soft cloth moistened with a mild soap solution. Do not use ammonia products, solvents or abrasives.

Do not use products such as air freshener that may contain alcoholic base.

Iluminación para uso doméstico.

No almacenar ni exponer a condiciones extremas de humedad o durante periodos prolongados.

No manipular el material eléctrico de la luminaria más allá del especificado para su montaje.

La instalación debe realizarse por personal técnico especializado.

No utilizar bombillas de potencia superior a la recomendada por el fabricante.

Para su limpieza, utilizar un paño suave ligeramente humedecido con una solución jabonosa.

No utilizar productos amoniacales, disolventes ni abrasivos. No pulverizar directamente, ni arrojar sobre la superficie productos ambientales y/o de base alcohólica.



FLOOR LAMP LÁMPARA DE PIE

MATERIAL: Brass

MATERIAL: Latón

LED
E14 7W x 4 units

WEIGHT PESO: 10 KG
Package size: 1,75 x 0,46 x 0,46

FINISHES
ACABADOS

LAQUERED
LACADOS



BLACK
NEGRO



WHITE
BLANCO



SLATE BLUE
AZUL PIZARRA

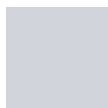

FOG BLUE
AZUL NIEBLA



GREY GREEN
VERDE GRIS



SOFT GREEN
VERDE SOFT



BURGUNDY
BORGOÑA



CORAL PINK
ROSA CORAL



PASTEL BLUE
AZUL PASTEL

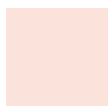

QUARTZ PINK
ROSA QUARZO

METALLIC
METÁLICOS



CHROME
CROMADO



COPPER
COBRE



GOLD
ORO

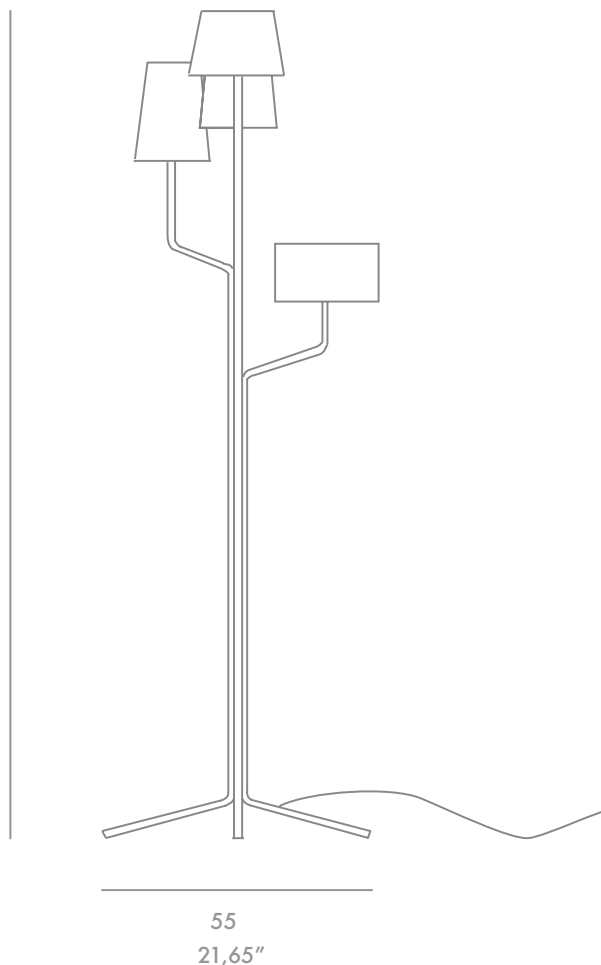

FABRIC LAMPSHADE (OPTIONAL)
PANTALLAS TEXTILES (OPCIONAL)



BLACK
NEGRO



RED
ROJO



WHITE
BLANCO

Lighting for domestic use.

Do not store or keep under extreme temperatures during long periods of time.

Do not handle the electrical material more than the necessary for installation of the fixture.

The installation must be done by specialized technical team.

Do not use bulbs with superior voltage as recommended by the manufacture.

For its cleaning, use only a soft cloth moistened with a mild soap solution. Do not use ammonia products, solvents or abrasives.

Do not use products such as air freshener that may contain alcoholic base.

Iluminación para uso doméstico.

No almacenar ni exponer a condiciones extremas de humedad o durante periodos prolongados.

No manipular el material eléctrico de la luminaria más allá del especificado para su montaje.

La instalación debe realizarse por personal técnico especializado.

No utilizar bombillas de potencia superior a la recomendada por el fabricante.

Para su limpieza, utilizar un paño suave ligeramente humedecido con una solución jabonosa.

No utilizar productos amoniacales, disolventes ni abrasivos. No pulverizar directamente, ni arrojar sobre la superficie productos ambientales y/o de base alcohólica.



WALL LAMP APLIQUE

MATERIAL: Brass

MATERIAL: Latón

LED
E14 7W x 3 units

WEIGHT PESO: 6 KG
Package size: 0,42 x 0,42 x 0,41

FINISHES
ACABADOS

LAQUERED
LACADOS



BLACK
NEGRO



WHITE
BLANCO



SLATE BLUE
AZUL PIZARRA

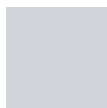

FOG BLUE
AZUL NIEBLA



GREY GREEN
VERDE GRIS



SOFT GREEN
VERDE SOFT



BURGUNDY
BORGOÑA



CORAL PINK
ROSA CORAL



PASTEL BLUE
AZUL PASTEL

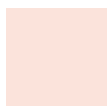

QUARTZ PINK
ROSA QUARZO

FABRIC LAMPSHADE (OPTIONAL)
PANTALLAS TEXTILES (OPCIONAL)



BLACK
NEGRO



RED
ROJO



WHITE
BLANCO

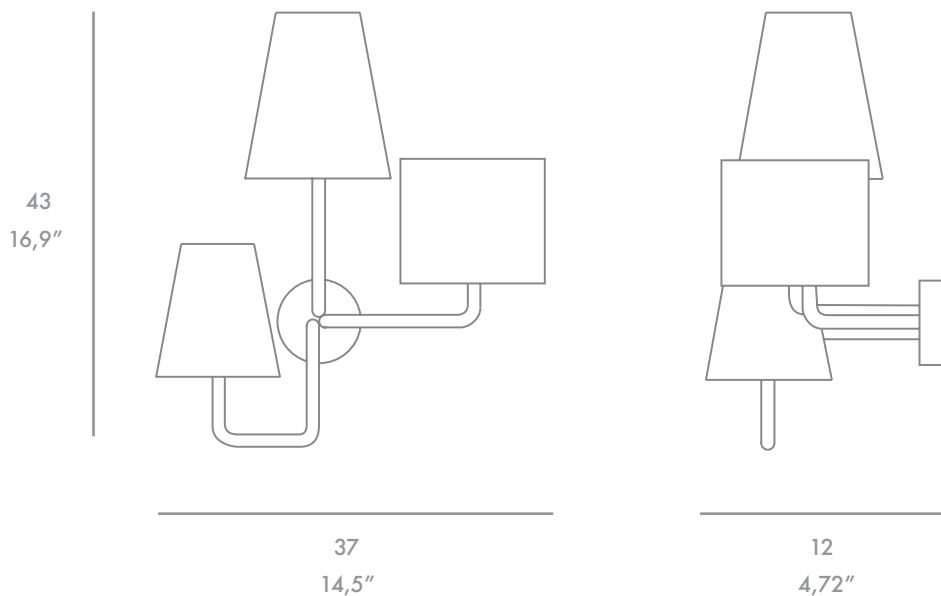

Lighting for domestic use.

Do not store or keep under extreme temperatures during long periods of time.

Do not handle the electrical material more than the necessary for installation of the fixture.

The installation must be done by specialized technical team.

Do not use bulbs with superior voltage as recommended by the manufacture.

For its cleaning, use only a soft cloth moistened with a mild soap solution. Do not use ammonia products, solvents or abrasives.

Do not use products such as air freshener that may contain alcoholic base.

Iluminación para uso doméstico.

No almacenar ni exponer a condiciones extremas de humedad o durante periodos prolongados.

No manipular el material eléctrico de la luminaria más allá del especificado para su montaje.

La instalación debe realizarse por personal técnico especializado.

No utilizar bombillas de potencia superior a la recomendada por el fabricante.

Para su limpieza, utilizar un paño suave ligeramente humedecido con una solución jabonosa.

No utilizar productos amoniacales, disolventes ni abrasivos. No pulverizar directamente, ni arrojar sobre la superficie productos ambientales y/o de base alcohólica.