

- Circular recessed LED downlight
- Aluminium body and cable gland machined from solid in 6082 alloy with black surface protection treatment
- Brushed and laser marked stainless steel frame AISI 316L
- Available with STAR optic, made in crystal
- Thermal shock resistant tempered, extraclear, anti-glare safety glass with grinded edges
- Circuit board in aluminium sp1.5mm with Led Cree
- Harmonic steel springs for ceiling installation.
- IP67 external power supply included
- IP68 connector for the connection between projector and power supply included
- Maximum permissible ambient temperature + 50°C

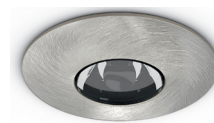

- *Proiettore LED da incasso circolare*
- *Corpo e pressacavo realizzati in alluminio tornito dal pieno lega 6082 anodizzati neri*
- *Cornice esterna in acciaio inox AISI 316L spazzolata e marcata a laser*
- *Disponibile con ottica STAR realizzata in cristallo*
- *Vetro di sicurezza temperato con bordi molati, extrachiaro ed antiriflesso resistente agli shock termici*
- *Circuito stampato in alluminio sp1.5mm con Led Cree*
- *Molle per installazione a soffitto in acciaio armonico.*
- *Alimentatore esterno IP67 incluso*
- *Connettore IP68 per la connessione fra proiettore ed alimentatore incluso*
- *Temperatura ambiente massima ammissibile +50°C*

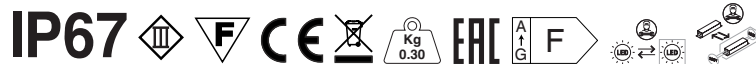
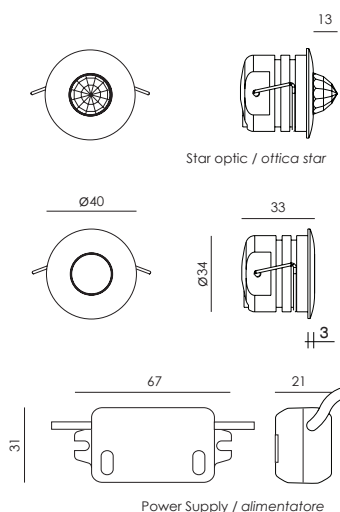

Lamp / Lampada PCB 1 LED CREE	Input / Alimentazione 220/240V 50/60Hz	Power / Potenza 1,5 / 3W	Color Tolerance/ Tolleranza Cromatica 2-SDCM / 3-SDCM	CRI / CRI 80 MIN
-------------------------------------	--	--------------------------------	---	------------------------



NEXO LUCE (Factory)
Strada Mirabella, 10
46040 Cavriana (MN), ITALY
T +39 0376 771513 F +39 0376 772235
sales@nexoluce.com www.nexoluce.com

Made in Italy

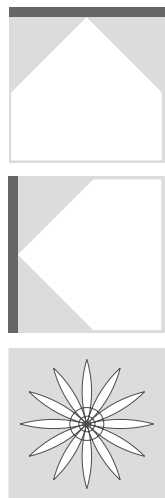

STAR EFFECT

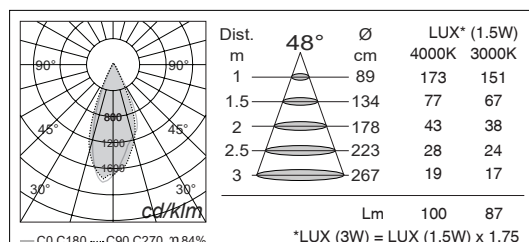
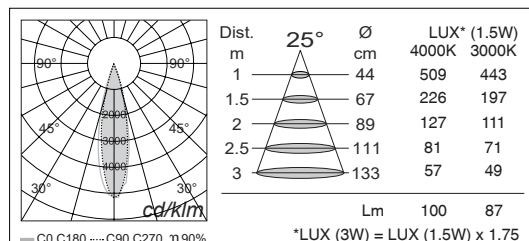
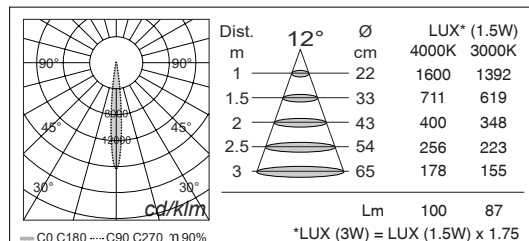
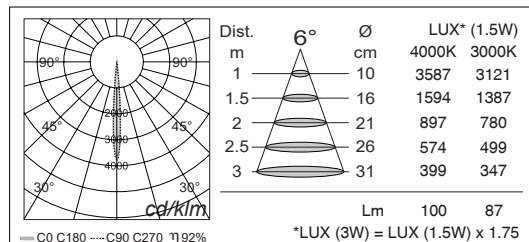
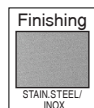

MAIN CODE CODICE BASE	RELEASE EDIZIONE	LIGHT COLOR COLORE LUCE	WATT WATT	OPTIC OTTICA	CONTROLLO CONTROL	FRAME COLOR COLORE
2107	.2	B 3000K	.01 1.5W	.A 6°	1 ON/OFF	.G STAIN. STEEL / INOX
		C 4000K	.03 3W	.C 12°		
		* others on request / altri su richiesta		.E 25°		
				.I 48°		
				AO STAR		

CODE EXAMPLE : Projector with warm white light color at 3000K, 3W, 12° optic, ON/OFF control, frame stainless steel color
2107.2B.03.C1.G

ESEMPIO DI CODIFICA : Proiettore con luce calda a 3000K, 3W, ottica 12°, controllo ON/OFF, colore in acciaio inox
2107.2B.03.C1.G

NEXO LUCE (Factory)
Strada Mirabella, 10
46040 Cavriana (MN), ITALY
T +39 0376 771513 F +39 0376 772235
sales@nexoluce.com www.nexoluce.com

Made in Italy