

# CORUM (129-005-204)

Manufacturer: Schmitz-Leuchten GmbH & Co. KG  
129-005-204 CORUM  
Surface: aluminium anodised  
Measurements (DxH): 615 x 80 mm  
Light distribution: direct / indirect  
Lightsource: LED, 4000K, Ra>80  
Connected load: max. 62 W  
Luminous flux of luminaire: 5520 lm  
Luminous efficacy: 67 lm/W  
Control Mode: ON/OFF  
Weight: 5,4 kg  
degree of protection: IP40  
protection class: 1

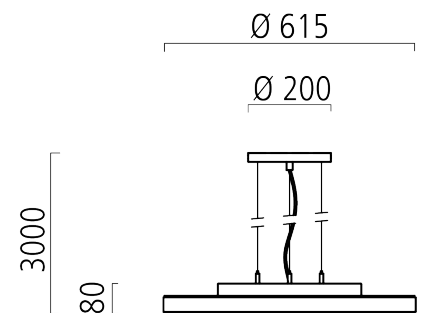

## Lighting Data

Lightsource: LED, 4000K, Ra>80  
Luminous flux of luminaire: 5520 lm  
Luminous efficacy: 67lm/W  
Connected load: 62 W  
Measurements (DxH): 615 x 80 mm  
Energy Efficiency Classification (EEC): A++,A+,A

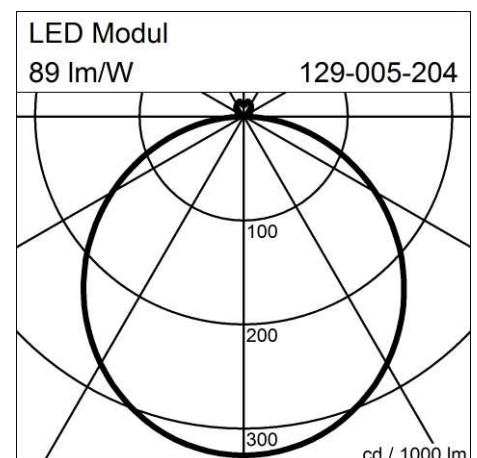

5 year warranty as specified in our terms of warranty at [www.schmitz-lighting.com/warranty](http://www.schmitz-lighting.com/warranty)

All data and information has been prepared with great care. Errors and omissions excepted. Product images are exemplary and may deviate from the original. We reserve the right improve and therefore change products at any time. © Schmitz-Leuchten GmbH & Co. KG  
Datasheet created/changed at 21.8.2016