

CORUM (129-004-224)

Manufacturer: Schmitz-Leuchten GmbH & Co. KG
129-004-224 CORUM
Surface: aluminium anodised
Measurements (DxH): 435 x 80 mm
Light distribution: direct / indirect
Lightsource: LED, 4000K, Ra>80
Connected load: max. 31 W
Luminous flux of luminaire: 2660 lm
Luminous efficacy: 69 lm/W
Control Mode: DIM DALI
Weight: 3 kg
degree of protection: IP40
protection class: 1

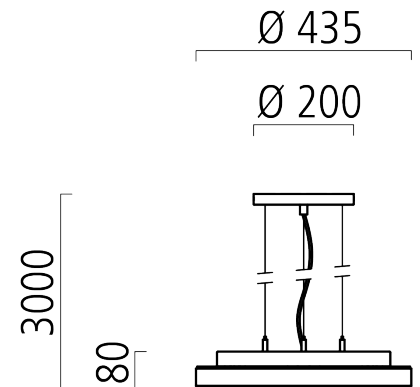

Lighting Data

Lightsource: LED, 4000K, Ra>80
Luminous flux of luminaire: 2660 lm
Luminous efficacy: 69lm/W
Connected load: 31 W
Measurements (DxH): 435 x 80 mm
Energy Efficiency Classification (EEC): A++,A+,A

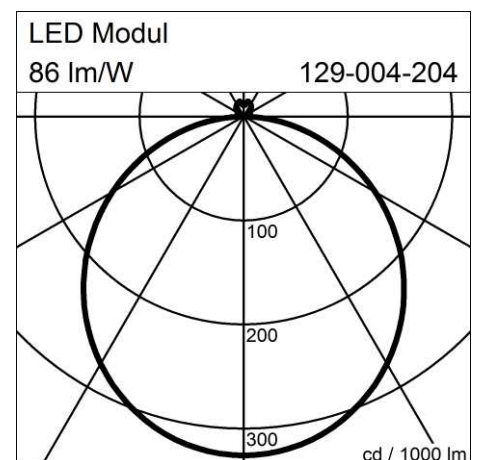

5 year warranty as specified in our terms of warranty at www.schmitz-lighting.com/warranty

All data and information has been prepared with great care. Errors and omissions excepted. Product images are exemplary and may deviate from the original. We reserve the right improve and therefore change products at any time. © Schmitz-Leuchten GmbH & Co. KG
Datasheet created/changed at 21.8.2016