

- PENDANTS: twenty-four
- MOUNTING: white powder coated round canopy 350mm (13.8") in diameter x 53mm (2") deep
- LAMPING: 1.5w LED (36w total draw)
- MATERIALS: poured glass, electrical components, white powder-coated canopy, bead blasted stainless steel armature components
- WEIGHT: approximately 73kg (160lb)
- TRANSFORMERS: Remote mounting recommended

DESCRIPTION

The 16.24 consists of twenty-four pendants and a modular stainless steel armature system mounted to a canopy. Installation of these creeping fixtures requires swag hooks every 1m (3') from the canopy or in groupings of more than 3 pendants to support long spans. Given the improvisational aspect of this fixture, appropriate structural support is required to hold 9kg (20lbs) for each swag hook throughout the entire area in which the fixture will be hung.

16 is formed by sequentially pouring three separate layers of coloured, molten glass – in varying opacities – on a horizontal plane. Each layer responds to the indeterminate shape of the previous pour to create a uniquely layered whole. Two of these pieces are then attached and illuminated with an internal LED lamp. The finished 16 is visually complex: each separate colour layer is visible through the other layers, with light reflecting along the edges.

A modular armature system connects the glass pieces to a series of branches and stems. Each armature segment carries low-voltage electricity and diverges into 2-4 separate branches, allowing both vertical and horizontal deployment with an infinite variety of possible forms. The branches simply click together during installation for custom, on-site arrangements.

NOTES

+ Purchase replacement lamps online at www.bocci.ca/lamps

US patent # D754,911
EU patent #002672774 - 0001 to 0012

Made in Vancouver, Canada

Vancouver
sales@bocci.ca
www.bocci.ca

Berlin
europe@bocci.ca
www.bocci.ca

approx 73kg (160lb)

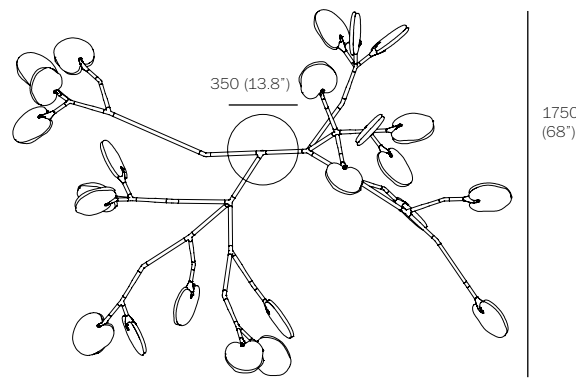
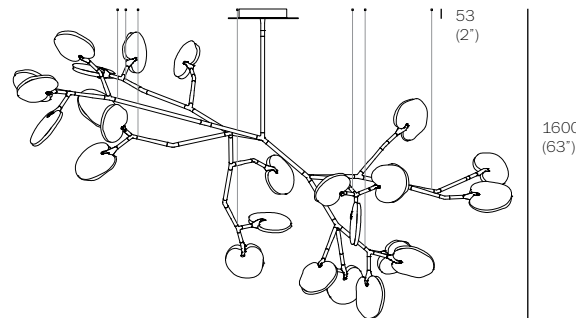
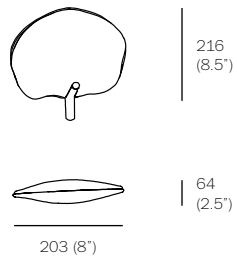

16.24

Design by Omer Arbel
PRODUCT SPECIFICATION

1900 (75')

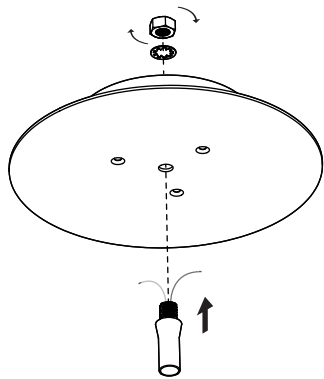

1

Insert the canopy connector into the canopy. Secure it with the lock washer and nut.

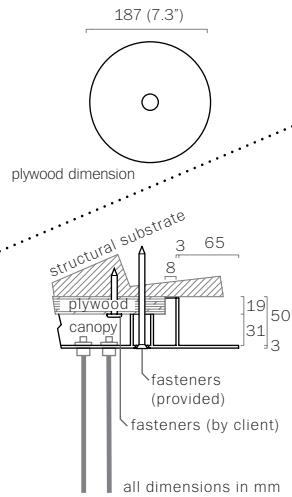

2

Measure and mark the light fixture canopy position on the ceiling.

Note: The client is responsible for providing a robust 19mm (3/4") plywood backing or MDF blocking to securely anchor to the structural substrate.

Connections from the plywood to the structural substrate are the client's responsibility. Measure the plywood so that it fits within the canopy side walls (refer to detail above).

Anchor the plywood backing to the structural ceiling substrate.

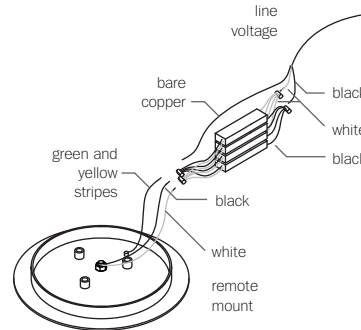

3

Connect the cables to the open slots in the terminal block on the 12V side of the transformers. Ensure that the braided outer wires are all connected to one 12V output wire and all inner insulated wires are connected to the other or a short will occur.

Once all coaxial connections are made, lift the fixture into position and connect the line voltage to the open slot in the appropriate terminal block.

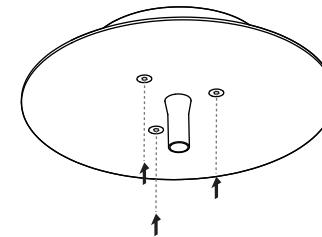

4

Anchor canopy into the plywood backing using the fasteners provided.

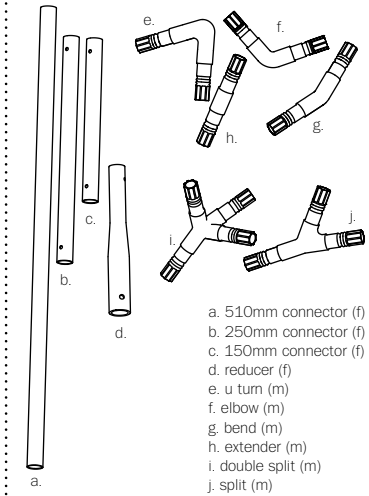

5

Take inventory of all the parts in the kit as you will use these to compose your fixture.

There may be ten types of components and up to three sizes of each piece (Ø17mm, Ø20mm, Ø25mm) depending on the fixture ordered.

You may use all the components, or any combination of them in your composition.

Note: The connectors on each end are either male (m) or female (f). A male part can only be joined with a female part.

Please refer to armature parts list for more details.

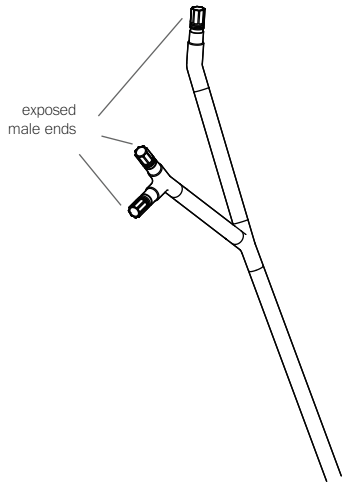

6

All exposed male connecting pieces will terminate with pendants, keep this in mind as you compose your light fixture. Installation strategy involves connecting a combination of straight female connector pieces and bent or branch male components.

Take your time to compose and recompose your light installation to achieve your chosen aesthetic (see bocci.ca for examples).

Note: It is easier to assemble branches in smaller sections before attaching to the canopy.

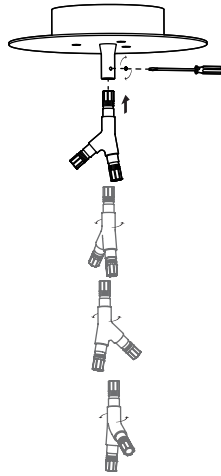

7

Each armature component can be rotated 45 degrees. Once the orientation is chosen, set in place using the set screws provided with a slotted screw driver. Each piece of tubing has 2 - 3 set screws around its circumference. These should be tightened evenly so that all set screws are engaged the same amount, centering the male end within the female connection.

Note: The size of the armature tubing corresponds to specific set screw sizes:

small Ø17mm (0.67") - M4
 medium Ø20mm (0.79") - M5
 large Ø25mm (0.98") - M6

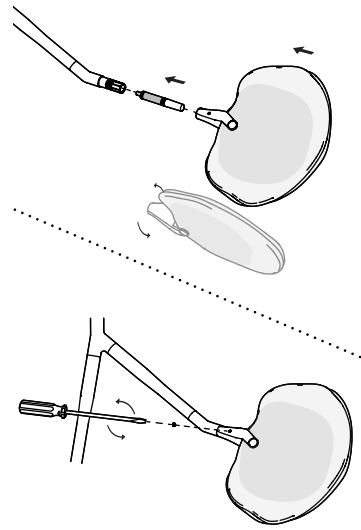

8

Insert LED into lampholder, and then plug each lampholder into all exposed male connections.

Slide the pendant onto the male connector, orient as desired, and secure using an M3 set screw (provided).

Note: If the fixture sags or seems unbalanced use swag hooks to add additional support.

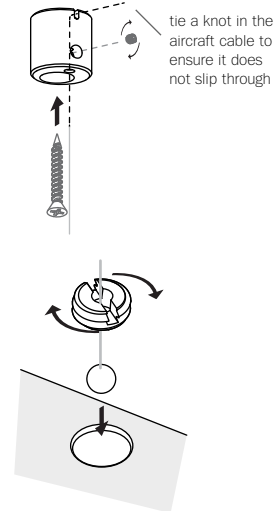

9

As you are assembling the fixture, add a swag hook every 1m (3') from the canopy or to any clusters of 3 or more pendants.

Part 1: Armature connection

Locate the M5 set screws with the hole in the middle on either medium armature components or on the pendant clamps. Thread the end without the ball from the concave side (opposite slotted side) through the set screw until the ball sets. Insert the set screw into the hole with the slotted side out. To tighten, bend the aircraft cable into the slot and use a screw driver.

Part 2: Ceiling connection

Locate a swag hook directly above the set screw and using the screws provided, fasten it into the ceiling. Pass the aircraft cable through the small hole on the bottom of the swag hook and thread it through until it emerges from the top parallel to the ceiling. Pull until tight, and tighten set screw on side. Tie a knot to make sure it does not slip through.

Note: Do not trim excess aircraft cable until entire fixture is complete. It may shift as pendants are added and cable lengths may need to be adjusted. Fasteners provided.

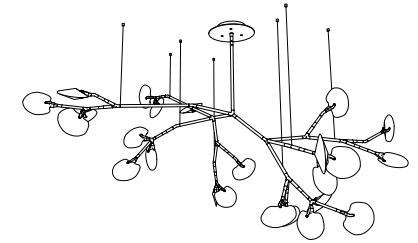

10

Repeat steps 7 - 9 until entire fixture is complete.

The centre of mass will shift as the fixture is assembled and you may have to adjust the swag hook lengths and locations throughout the install so leave excess aircraft cable emerging from the swag hooks until all pendants are added.

Tighten all set screws, trim excess aircraft cable and clean fingerprints from pendants.

Turn light fixture on.

For additional assistance, please contact Bocci:

Vancouver
 sales@bocci.ca
 www.bocci.ca

Berlin
 europe@bocci.ca
 www.bocci.ca

US patent # D754,911
 EU patent # 002672774-0001 to 0002

Made in Vancouver, Canada