



REF.



Per ogni voce selezionare l'opzione scelta  
For each item select the chosen option

1

# .DOT

FOLIO®

product type	sizes	LED position	CCT	al finish	op finish	fixing	warranty	dimm.	LED type	IP Rating	Indirect Light			
Q.ty	03													

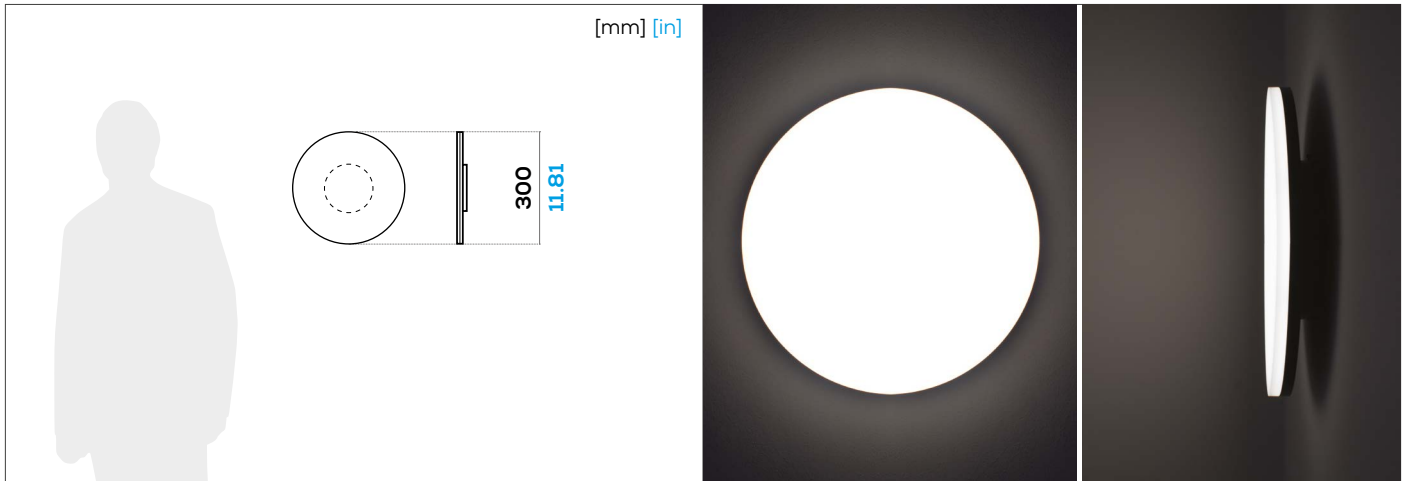

ø 300 mm    ø 11.87 in

Altre dimensioni disponibili.  
Custom size available.

## CERTIFICATIONS



## APPLICATIONS

A soffitto  
Ceiling



A parete  
Wall

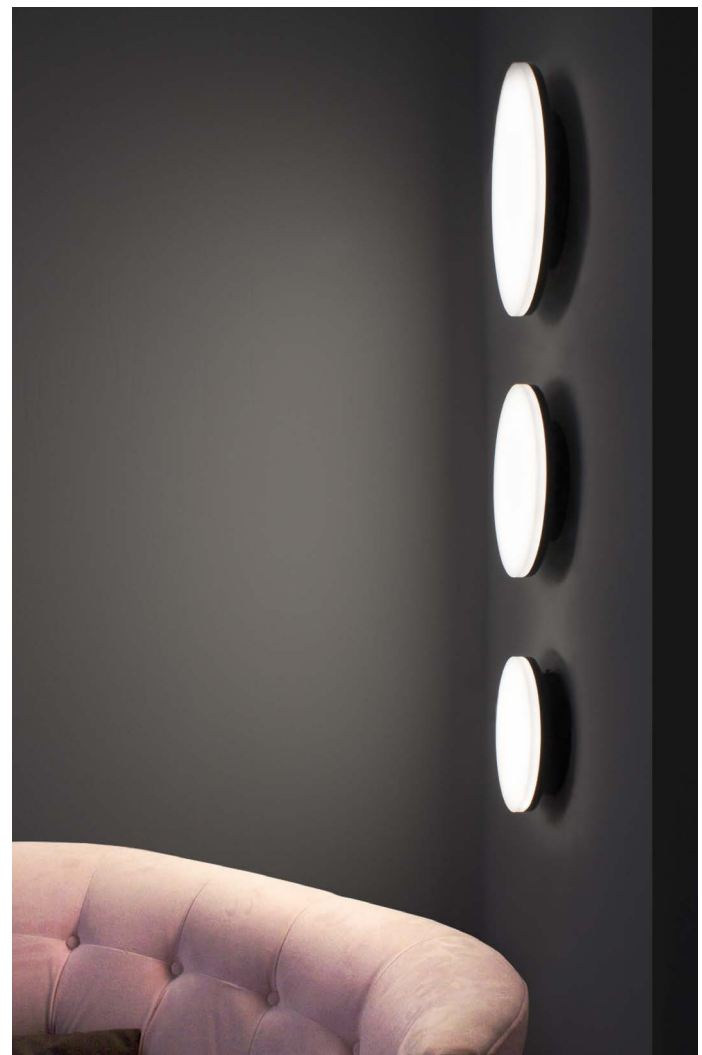
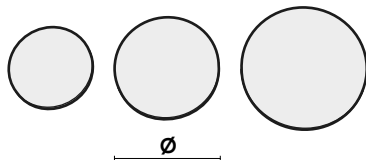

## TECHNICAL DESCRIPTION

DOT fa parte della serie di prodotti MINI, ideale per creare varie composizioni. Omogeneità luminosa garantita dal diffusore opale con spessore 10 mm e dalla lastra interna in metacrilato incisa a laser con tecnologia edge lighting. Protezione esterna con scocca in alluminio per favorire la rigidità e la dissipazione del calore. LED Nichia ad alta efficienza energetica, dimmerabili 0-10 V, DALI, DMX o Casambi. Disponibile nelle versioni con alimentatore remoto o con alimentatore integrato.

DOT is part of the MINI product series, ideal for creating various compositions. Homogeneous luminosity is guaranteed by the opal diffuser with a thickness of 10 mm. The internal methacrylate plate is laser engraved with lighting edge technology. The external protection made of an aluminum shell favours rigidity and heat dissipation. The Nichia LEDs with high energy efficiency, are dimmable 0-10 V, DALI, DMX or Casambi. Available either with remote or integrated power supply.



REF.

Per ogni voce selezionare l'opzione scelta  
For each item select the chosen option

2

**.DOT****FOLIO**

product type	sizes	LED position	CCT	al finish	op finish	fixing	warranty	dimmm.	LED type	IP Rating	Indirect Light			
Q.ty	03													

OPTION .A	OPTION .B
versione <b>alimentazione remota</b> remote power supply version	versione <b>alimentazione integrata</b> integrated power supply version
<b>35</b> (20 + 15) <b>1.37</b> (0.78 + 0.59)	<b>48</b> (20 + 28) <b>1.88</b> (0.78 + 1.10)

 QUANTITÀ  
 QUANTITIES

ø 300 mm    ø 11.87 in



## PHYSICAL SPECS.

 Tipologia di prodotto:  
 Product type:

- DO.A** Versione con **alimentazione remota**  
(alimentatore non incluso)  
**Remote power supply** version  
(power supply not included)
- DO.B** Versione con **alimentazione integrata**  
(alimentatore non incluso)  
**Integrated power supply** version  
(power supply not included)

 Spessore:  
 Thickness:

**DO.A** 35 mm  
 1.37 in

 Spessore:  
 Thickness:

**DO.B** 48 mm  
 1.88 in

 Peso:  
 Weight:

 2,45 kg  
 5.40 lb

 Materiali:  
 Materials:

 Alluminio - Metacrilato  
 Aluminum - Methacrylate

 Dimensioni:  
 Sizes:

 ø 300 mm  
 11.87 in

## GENERAL SPECS.

 Installazione:  
 Fixing:

- W** A parete  
Wall
- C** A soffitto  
Ceiling

 Ambiente di utilizzo:  
 Environment of use:

 Interno  
 Indoor

 Durata LED:  
 LED lifespan:

 L90 > 60.000 ore a 50° Celsius  
 L90 > 60.000 hours at 50° Celsius

 Blue light risk group:  
 Blue light risk group:

 EXEMPT UNLIMITED (200 mm)  
 EXEMPT UNLIMITED (7.87 in)

 Garanzia:  
 Warranty:

- 2Y** 2 anni  
2 years
- 5Y** Su richiesta estensione fino a 5 anni  
On request extension up to 5 years

## FINISHES

 Finiture alluminio:  
 Aluminum finishes:

- W** bianco  
white
- B** nero  
black
- S** speciale (verniciatura o ossidazione)  
special (liquid painting or oxidation)

 Finiture opale:  
 Opal finishes:

- M** opaco  
matte
- G** lucido  
gloss
- OM** opale fresato  
opal milling
- OS** opale inciso laser  
opal sculpture
- OP** opale + stampa  
opal + print
- OA** opale + stampa lucida (Folio Art)  
opal + glossy print (Folio Art)



# .DOT



Q.ty	product type	sizes	LED position	CCT	al finish	op finish	fixing	warranty	dimm.	LED type	IP Rating	Indirect Light				
		03														

## ELECTRICAL SPECS.

Voltaggio:

Voltage:

Driver - alimentatore:

Driver - power supply:

Dimmerabilità:

Dimmability:

24V DC

AC/DC 24V

 **O10** 0-10 V **DA** DALI **DM** DMX **CA** Casambi

## LED

Tipologia LED:

LED type:

 **N** **NICHIA 757 R9050** **O** *Nichia Optisolis™ (su richiesta)*  
*Nichia Optisolis™ (on request)* **V** *Nichia Vitasolis™ (su richiesta)*  
*Nichia Vitasolis™ (on request)*

Posizione LED:

LED position:

 **P1** Perimetro  
Perimeter

Consumo:

Consumption:

**P1** 22 W

Flusso luminoso output:

Luminous flux output:

**P1** 804 lm

Indice di resa cromatica:

Color rendering index:

**N** Standard:  
CRI = Ra min. 90 - R9 min. 50**O** *Su richiesta Ra = 100*  
*(Nichia Optisolis™)*  
*On request Ra = 100*  
*(Nichia Vitasolis™)*

Grado di protezione:

IP rating:

- 40** Standard:  
**IP40**
- 65** *IP65 (su richiesta)*  
*IP65 (on request)*
- DL** *Damp Location (su richiesta)*  
*Damp Location (on request)*

Temperatura colore LED:

LED color temp. (CCT):

- 27**  2700 K
- 30**  3000 K
- 35**  3500 K
- 40**  4000 K
- 57**  5700 K
- TW**  Tunable White (2700 K - 5700 K)
- RQ** *Su richiesta 2000K, 2200K, 2500K,*  
*5000K, 6500K, RGB, RGBW and*  
*RGBTW*  
*On request 2000K, 2200K, 2500K,*  
*5000K, 6500K, RGB, RGBW and*  
*RGBTW*

## UGR

Indici di riflessione:

Reflectance indexes:

X = 4H, Y = 8H, S = 0,25H

70/ 50/ 20

UGR trasversale:

UGR crosswise:

&lt; 19

UGR longitudinale:

UGR endwise:

&lt; 19

## POLAR DIAGRAM

[cd/klm]

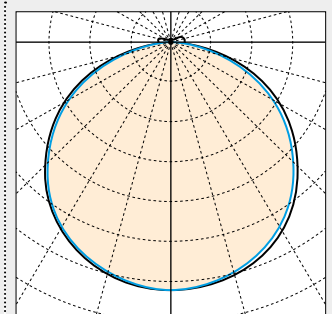

C180 C270 C0 C90



REF.



Per ogni voce selezionare l'opzione scelta  
For each item select the chosen option

4

# .DOT







Q.ty	product type	sizes	LED position	CCT	al finish	op finish	fixing	warranty	dim.	LED type	IP Rating	Indirect Light				
		03														

## LIGHTING ACCESSORIES





Folio Indirect Light:



### FOLIO BASE

- 27  2700 K
- 30  3000K
- 35  3500K
- 40  4000K
- 57  5700K
- RQ *Su richiesta 2000K, 2200K, 2500K, 6500K, RGB and RGBW*  
*On request 2000K, 2200K, 2500K, 6500K, RGB and RGBW*

### FOLIO LINEAR

- TINY TINY
- TY45 TINY 45
- STK STOCKY
- 30  3000K
- 40  4000K
- 57  5700K
- TW  Tunable White (2700 K - 5700 K)
- R  RGB
- RQ *Su richiesta 2000K, 2200K, 2500K, 2700K, 3500K and 6500K*  
*On request 2000K, 2200K, 2500K, 2700K, 3500K and 6500K*

## KEY TO SYMBOLS

Folio Indirect Light:

