

TRE T670 DIMMER 220V

ver. 20200404_Rev_0

year: 2014
code: 1740401E75603
type: table lamp
application: indoor

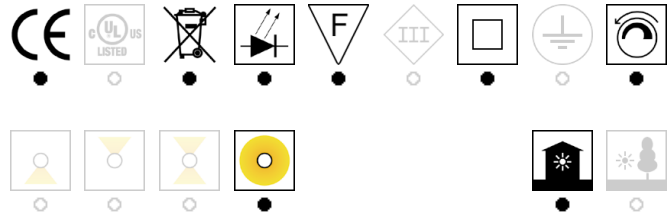

Technical drawing ref. image mm - inch

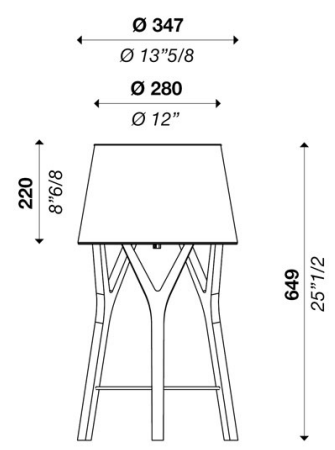

Technical data

Light source	LED bulb
Circuit structure	LED bulb
Light emission direction	diffused
Power	1x MAX 20W E27
Source lumens	-
Source efficacy	-
Energy class	A
Delivered lumens	-
Secondary	-
Colour temperature	-
Colour rendering index	-
Standard Deviation of Colour Matching	-
Safety class	II
Degree of protection	IP 20
Direct mounting on normally flammable surfaces	●
Operating temperature	+10° / +40°
CE	●
UL	○

Optional

Emergency mode	○
Motion sensor	○
Directional	○

Packing

Net weight	
Packaging 1	L510 x W420 x H720 mm / 5.5 kg
Packaging 2	
Packaging 3	
Packaging 4	
Packaging 5	

Structure

Material	wood
Finish	canaletto walnut / variants page 2

Diffuser

Material	
Finish	

Lampshade

Material	fabric + polycarbonate
Finish	black outside / variants page 2

Electronics / Driver

Included	No
Quantity	
Voltage	220-240V 50/60 Hz

Dimmable



Hanging cables

Stainless steel cables standard length (custom available)	○
Electric cable standard length (custom available)	-

Warranty

Duration	2 years
----------	---------



TRE T670 DIMMER 220V

ver. 20200404_Rev_0

year: **2014**
 code: **1740401E75603**
 type: **table lamp**
 application: **indoor**

Available variants





Colour temperature

2700 k	3000 k	3500 k	4000 k	bulb	custom
					
<input type="radio"/>	<input type="radio"/>	<input type="radio"/>	<input type="radio"/>	<input checked="" type="radio"/>	<input type="radio"/>

Structure finish

gold / brass	natural	dark stained	black stained	walnut stained	matt black lacquered	laccato caffe royal	custom
							
<input type="radio"/>	<input checked="" type="radio"/>	<input type="radio"/>	<input type="radio"/>	<input type="radio"/>	<input type="radio"/>	<input type="radio"/>	<input checked="" type="radio"/>

Secondary finish

white	black	grey	ivory
			
<input type="radio"/>	<input checked="" type="radio"/>	<input type="radio"/>	<input checked="" type="radio"/>