

io tavolo datasheet

LED table lamp with spherical head, movable in any direction thanks to Occhio 3D kinematics with two pivots set at an angle of 22.5° to each other; operation via heat-insulated grip pads. Lighting effect can be changed through optional inserts; dichroitic color filters can be additionally inserted. Power 13W or 18W (preselectable), switchable and dimmable by hand movement control via touchless sensor (can be deactivated). Power supply via plug mains adapter (converter); cable in the base can be rolled up. Surface combinations of head, pads, body and base can be configured as desired; pads changeable.

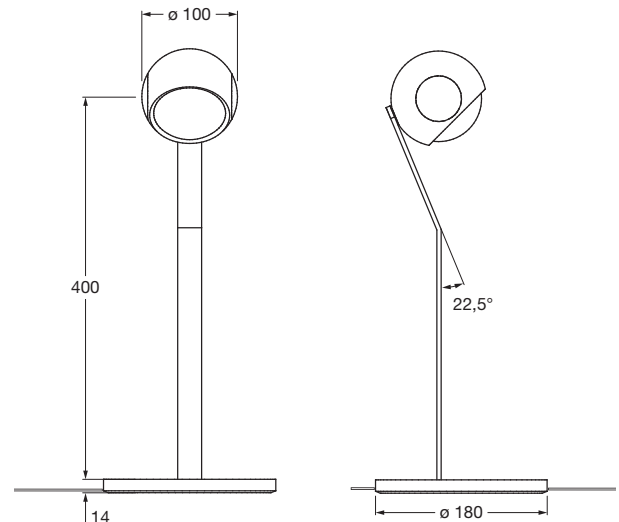
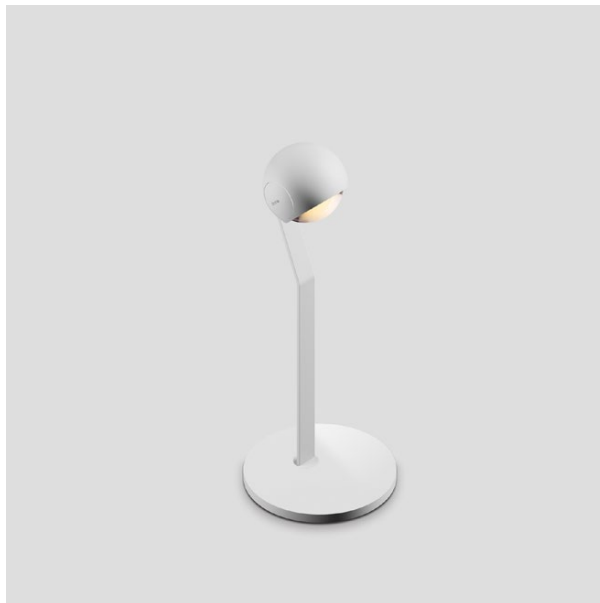

Dimensions in mm

technical data io tavolo

properties	material	aluminium, zinc chrome-plated or painted, optical plastic, glass
	turning range head	360°
	turning range body	360° (with stop)
	weight	2.40 kg
surface	head	matt gold, rose gold, bronze, shiny chrome, matt chrome, glossy white, matt white, matt black, phantom, black phantom
	pads	rose gold, bronze, shiny chrome, matt chrome, glossy white, matt white, matt black
	body	shiny chrome, matt chrome, matt white, matt black
	base	shiny chrome, matt chrome, glossy white, matt white, matt black
Occhio LED	average life time	> 50.000 hrs
	energy efficiency class (luminous efficiency)	G (63 lm / W)
	power	LED 18 W (incl. Occhio power supply unit approx. 22 W, standby < 0.5 W) / LED 13 W (incl. Occhio power supply unit approx. 15 W, standby < 0.5 W)
	color rendering index	perfect color; CRI Ra 97 high flux; CRI Ra 85
	color temperature (color consistency)	2700 K, 3000 K (2-step) 3000 K, 3500 K, 4000 K (2-step)
electricity	dimming	by integrated touchless sensor in head
	power supply unit	with integrated converter, cable length 180 cm
	power factor power supply (cos φ1)	0.9
	flicker / stroboscopic effect	1 (PstLM) / 0.9 (SVM)
	permitted operating conditions	max. 30°C for indoor use only

io tavolo lighting effects

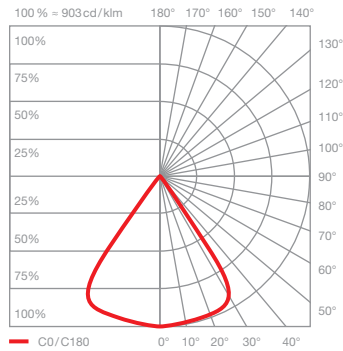
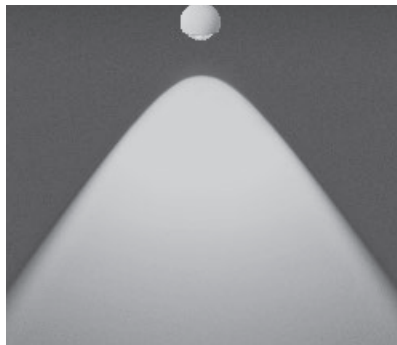

io C
directed light (approx. 80°)

inserts:	lens		
luminous flux:	perfect color	18W	1170lm
	high flux	18W	1610lm
	perfect color	13W	800lm
	high flux	13W	1170lm

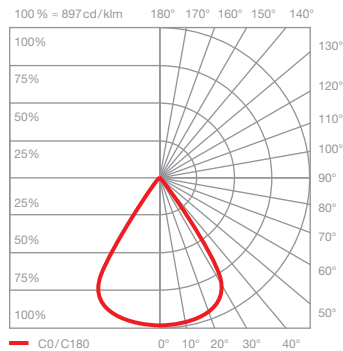
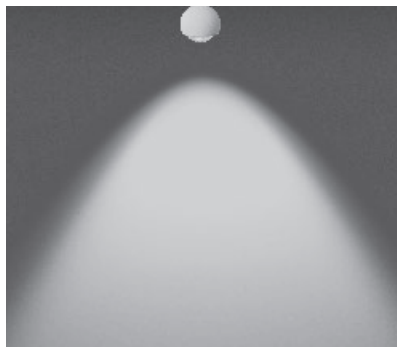

io C with soft edge glass
directed light with soft contour of the beam angle (approx. 80°)

inserts:	lens soft edge glass		
luminous flux:	perfect color	18W	1070lm
	high flux	18W	1470lm
	perfect color	13W	740lm
	high flux	13W	1070lm

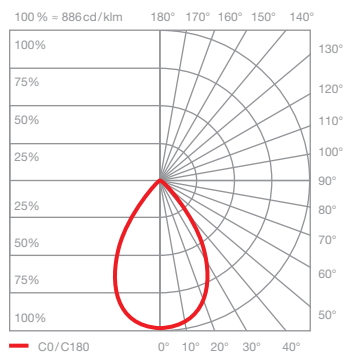
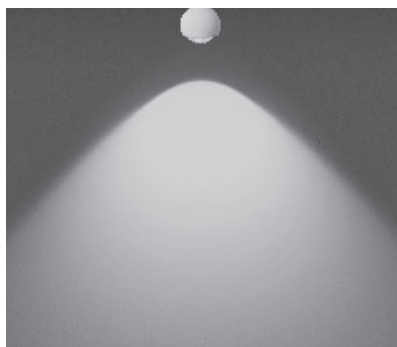

io C with satinised glass
diffused light with soft widening of the beam angle (approx. 100°)

inserts:	lens satinised glass		
luminous flux:	perfect color	18W	910lm
	high flux	18W	1250lm
	perfect color	13W	630lm
	high flux	13W	910lm

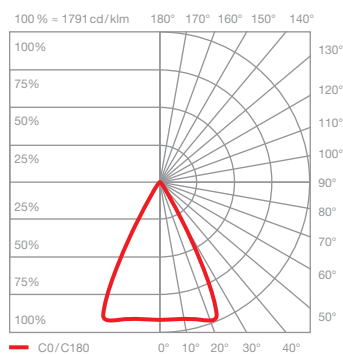
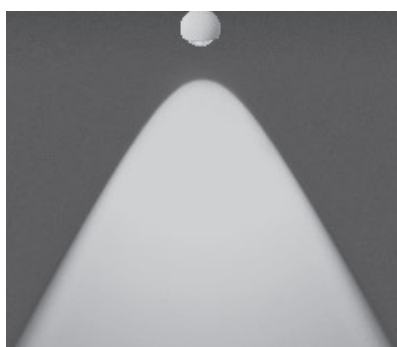

io C with fresnel lens
bundled light
beam angle approx. 60°

inserts:	lens fresnel lens		
luminous flux:	perfect color	18W	990lm
	high flux	18W	1360lm
	perfect color	13W	680lm
	high flux	13W	990lm