

io piano v pro datasheet

LED ceiling recessed spotlight as a downlight with spherical head and lens optics; mounting flush with ceiling for hollow ceilings or solid ceilings with ceiling box.

Version with remote power supply unit; connection to external power source (driver). Dimmable via customer-supplied dimmable power supply unit. Choice of several variants for different installation solutions. Covers that are held in place magnetically are used in ceiling-mounted versions and in frameless models which have a mounting plate for mounting to hollow ceilings.

Lighting effect through optional inserts can be changed at any time using a simple mechanism; the Occhio light module is replaceable.

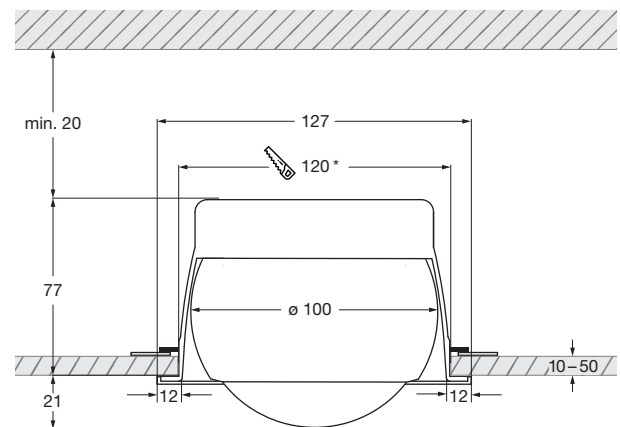
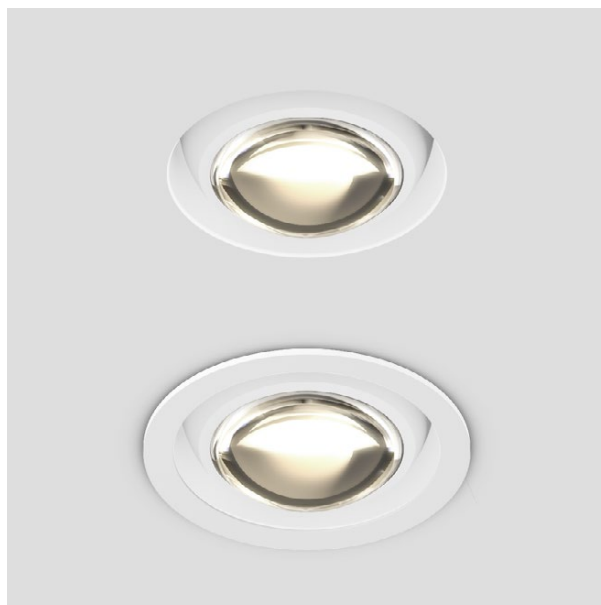

* cut-out dimensions
Installation depth: 97 mm

dimensions in mm

technical data io piano v pro

properties	material	aluminium chrome-plated, painted or anodised, plastic, glass, optical plastic		
	weight	1.10 kg		
surface	head	matt gold, rose gold, bronze, shiny chrome, glossy white, matt white, matt black, phantom, black phantom		
	tube	matt white, matt black		
	cover	matt gold, rose gold, bronze, shiny chrome, matt white, matt black, phantom, black phantom		
Occhio light module	average life time	> 50.000 hrs		
	energy efficiency class (luminous efficiency)	G (85 lm / W)		
	power	LED 13 W		
	color rendering index	perfect color; CRI Ra 97	high flux; CRI Ra 85	
	color temperature	2700 K, 3000 K	3000 K, 3500 K, 4000 K	
electricity	dimming	dimmable with suitable power supply unit		
	power supply unit	max. 350 mA const. / >36 V DC		
	permitted operating conditions	max. 30°C for indoor use only		

io piano v pro mounting options

io piano v pro
ø head 100 mm, H 50 mm

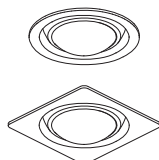

mounting tube with cover

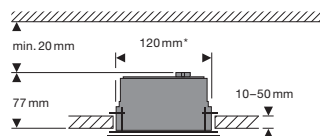

hollow ceiling



cover

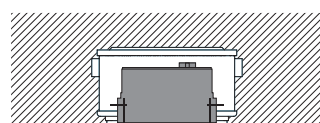

concrete ceiling
(Kaiser HaloX 180 with mineral-fibre board)
driver max. L 130 mm x W 30 mm

io piano v pro pure
ø head 100 mm, H 50 mm

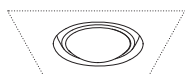

mounting board for seamless mounting

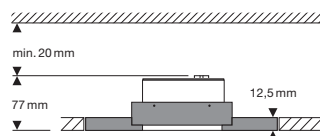

hollow ceiling
(mineral-fibre board with holding ring)

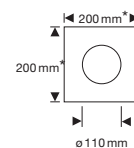

*cut-out dimensions

io piano v pro lighting effects

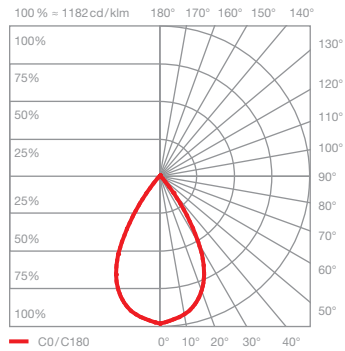
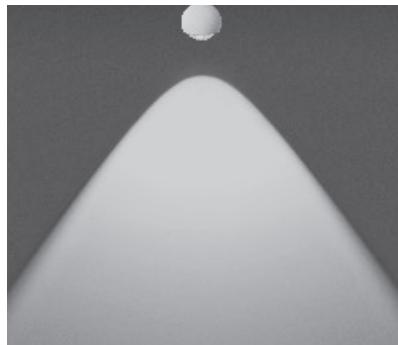

io C
directed light with contour beam angle
(approx. 80°)*

inserts: lens

luminous flux: perfect color 13 W 1010lm
high flux 13 W 1460lm

*without aperture

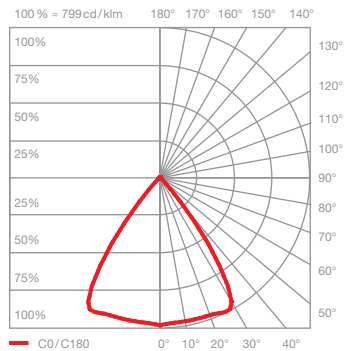
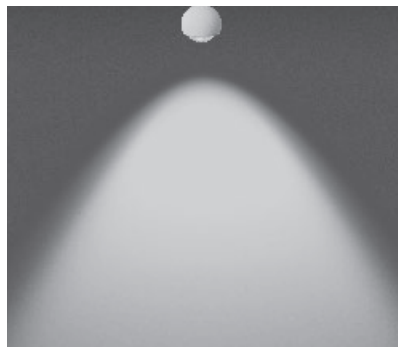

io C with soft edge glass
directed light with soft contour beam angle
(approx. 80°)

inserts: lens
soft edge glass

luminous flux: perfect color 13 W 900lm
high flux 13 W 1300lm

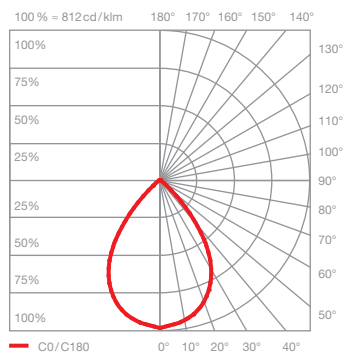
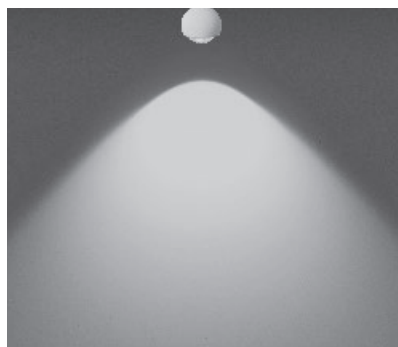

io C with satinised glass
directed light with soft contour beam angle
(approx. 100°)

inserts: lens
satinised glass

luminous flux: perfect color 13 W 740lm
high flux 13 W 1070lm

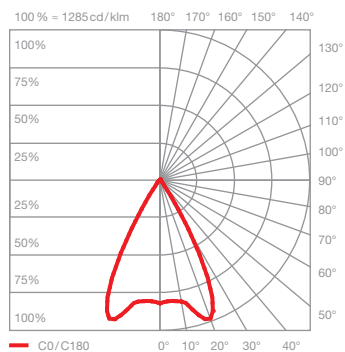
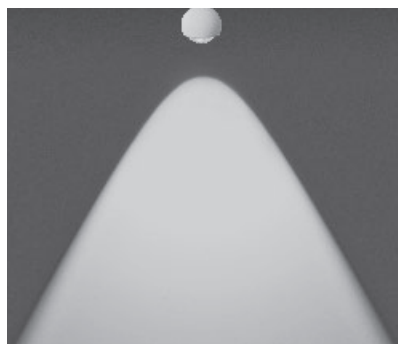

io C with fresnel lens
bundled light
beam angle approx. 60°

inserts: lens
fresnel lens

luminous flux: perfect color 13 W 830lm
high flux 13 W 1210lm