

Sito verticale datasheet

LED wall spotlight for exterior with spherical head and double-sided light output (up/down vertical). The lighting effect can be decided upon purchase.

The wall spotlight complies with protection class IP65 and is thus dust-tight and jet-proof. Version for surface mounting, connection to 230 V (AC) mains voltage (VOLT light engine), dimmable via trailing-edge phase-cut dimmer*.

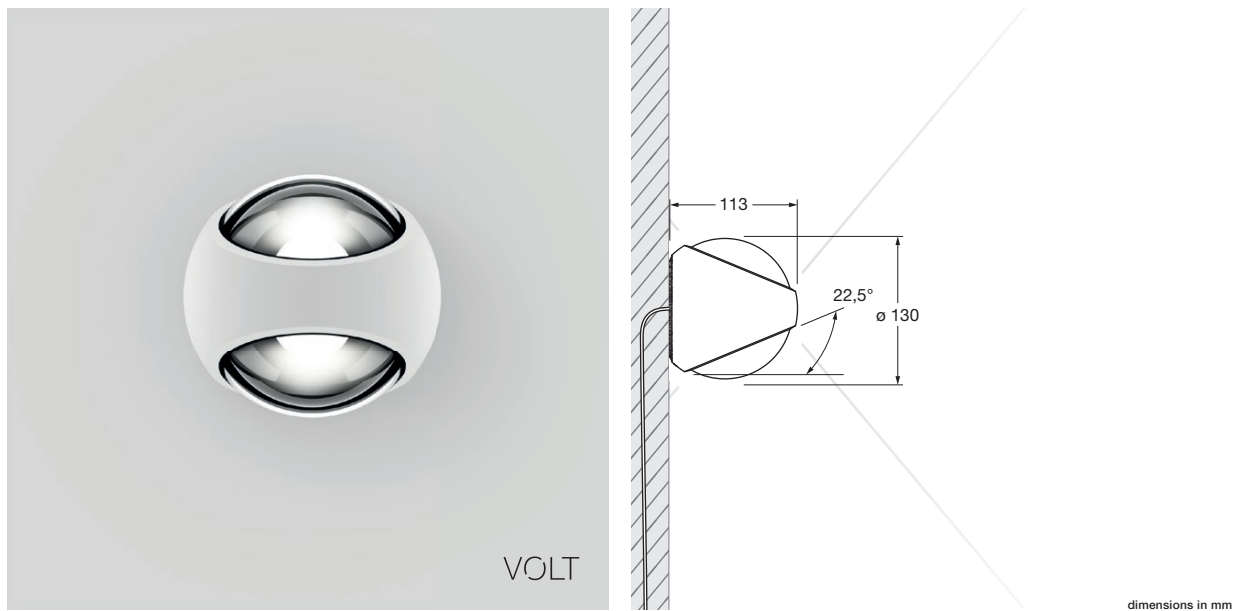

dimensions in mm

technical data Sito verticale

properties	material	aluminium, painted, optical glass
	weight	1.3 kg
surface	head	matt white, glossy white, matt black
	VOLT light engine	
	average life time	> 40.000 hrs
	energy efficiency class (luminous efficiency)	G (72 lm / W)
	power	LED 2 x 9 W
	color rendering index	perfect color; CRI Ra 97
	color temperature (color consistency)	2700 K, 3000 K (2-step)
electricity	dimming	by trailing-edge phasecut dimmer *
	connection	230 V AC / 50 Hz
	power factor power supply (cos φ1)	0.9
	flicker / stroboscopic effect	1 (PstLM) / 0.9 (SVM)
	permitted operating conditions	-20°C to +40°C

* For a list of compatible dimmers, see www.occhio.de/dim_en

Sito verticale lighting effects

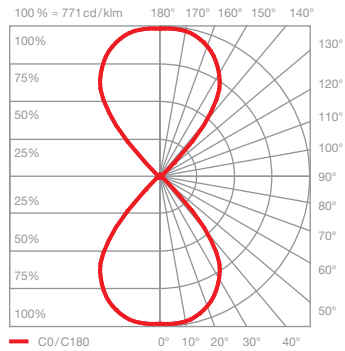
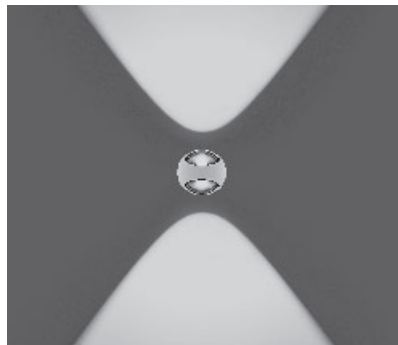

C80 contour

scattered light with contour beam angle
(approx. 80°)

inserts: spherical glass
 small lens medium

luminous flux: perfect color 2 × 9W 1100lm

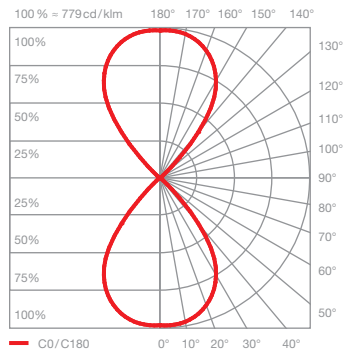
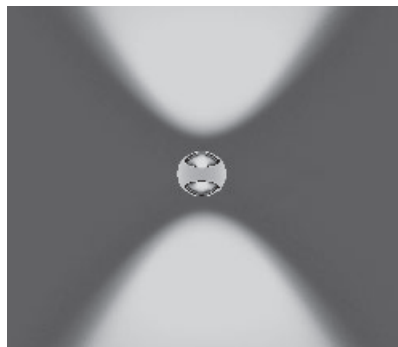

S80 soft

scattered light with soft contour beam angle
(approx. 80°)

inserts: spherical glass
 small lens medium
 soft edge glass

luminous flux: perfect color 2 × 9W 980lm

Sito verticale connect several luminaires

through-wired with buried exterior
junction box

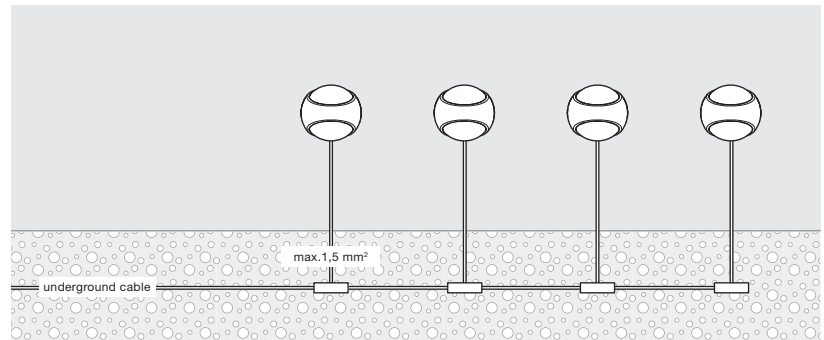

through-wired with plug in terminals

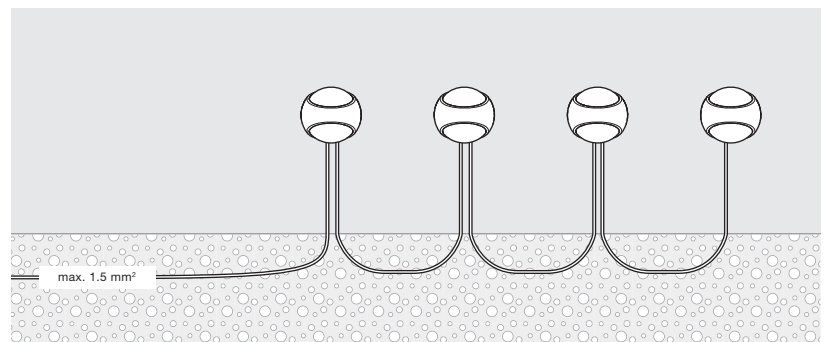

Occhio air module in switch box or
distribution box



max. 4 luminaires

