

## Sito lato datasheet

LED wall/ceiling luminaire for exterior with spherical head and single-sided light output. For use on walls to illuminate steps or paths. Available either with spherical glass (Sito) or flat glass (Sito R) with internal lens, the lighting effect can be decided upon purchase.

The wall/ceiling luminaire complies with protection class IP65 and is thus dust-tight and jet-proof. Version for surface mounting, connection to 230 V (AC) mains voltage (VOLT light engine), dimmable via trailing-edge phase-cut dimmer\*.

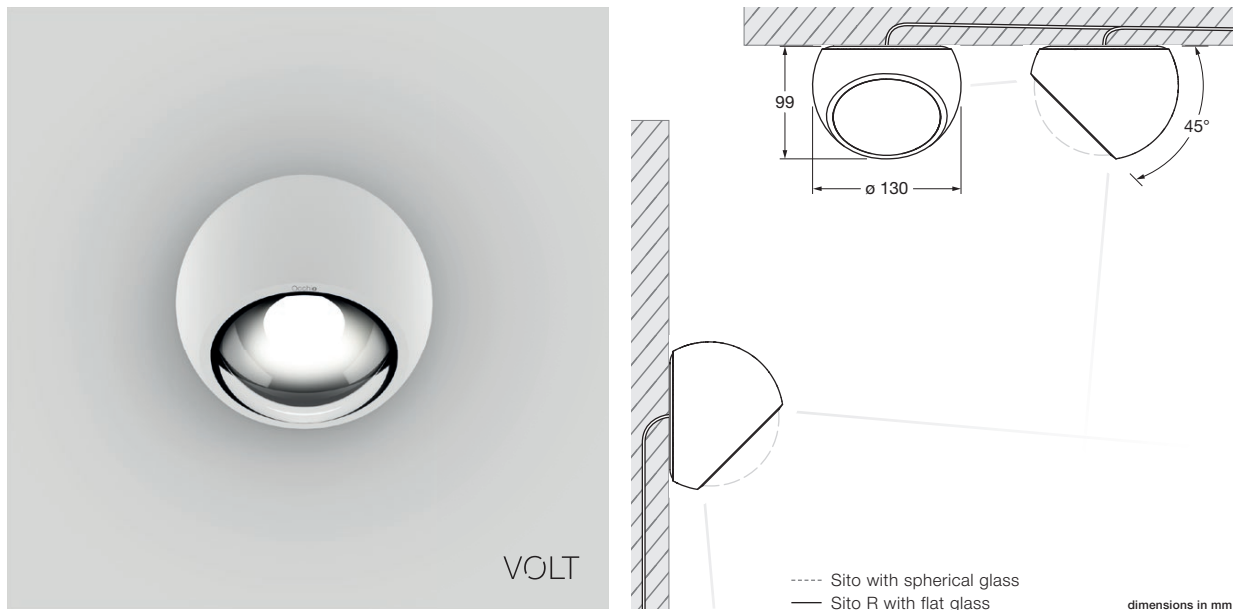

### technical data Sito lato

properties	material	aluminium, painted, optical glass
	movability	45° (with stop and fixable)
	weight	1.5 kg
surface	head	matt white, glossy white, matt black
VOLT light engine	average life time	> 40.000 hrs
	energy efficiency class (luminous efficiency)	G (72 lm/W)
	power	LED 18 W
	color rendering index	perfect color; CRI Ra 97
	color temperature (color consistency)	2700 K, 3000 K (2-step)
electricity	dimming	by trailing-edge phasecut dimmer *
	connection	230 V AC / 50 Hz
	power factor power supply (cos φ1)	0.9
	flicker / stroboscopic effect	1 (PstLM) / 0.9 (SVM)
	permitted operating conditions	-20°C to +40°C

\* For a list of compatible dimmers, see [www.occhio.de/dim\\_en](http://www.occhio.de/dim_en)

## Sito lato Sito lighting effects

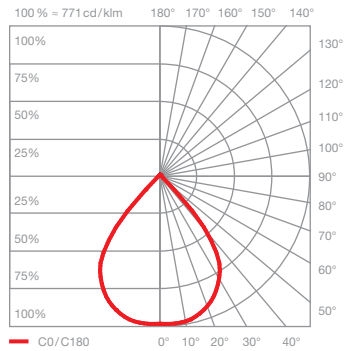

### C80 contour

scattered light with contour beam angle  
(approx. 80°)

inserts:            spherical glass  
                         small lens medium

luminous flux :    perfect color    18 W    1100 lm

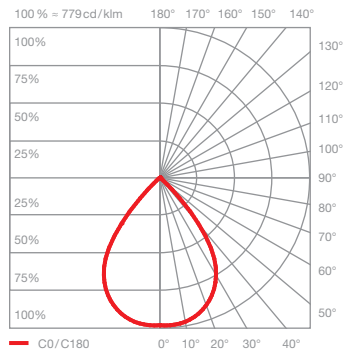
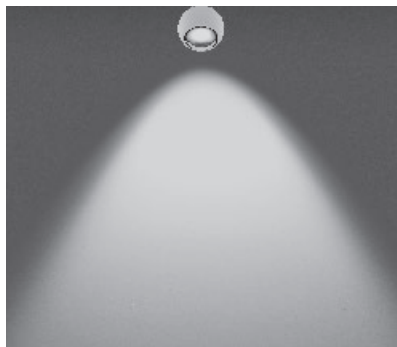

### S80 soft

scattered light with soft contour beam angle  
(approx. 80°)

inserts:            spherical glass  
                         small lens medium  
                         soft edge glass

luminous flux :    perfect color    18 W    980 lm

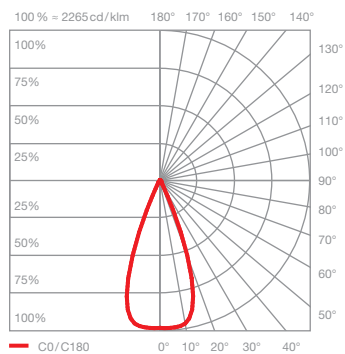

### S40 soft

scattered light with soft contour beam angle  
(approx. 40°)

inserts:            spherical glass  
                         small lens medium  
                         fresnel lens

luminous flux :    perfect color    18 W    870 lm

## Sito lato Sito R lighting effects

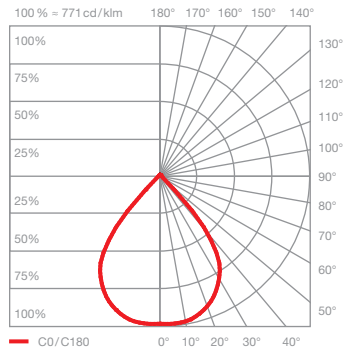

### C80 contour

scattered light with contour beam angle  
(approx. 80°)

inserts:            flat glass  
                         small lens medium

luminous flux :    perfect color    18 W    1100 lm

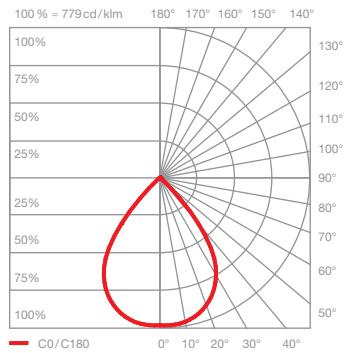
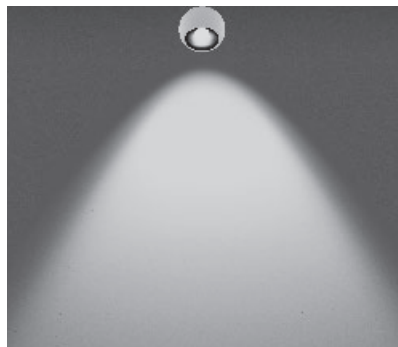

### S80 soft

scattered light with soft contour beam angle  
(approx. 80°)

inserts:            flat glass  
                         small lens medium  
                         soft edge glass

luminous flux :    perfect color    18 W    980 lm

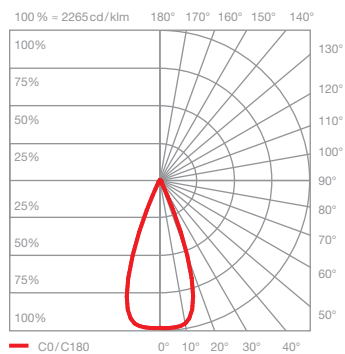
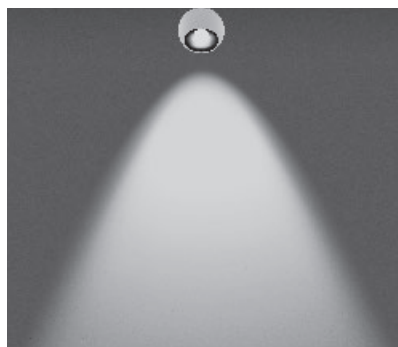

### S40 soft

scattered light with soft contour beam angle  
(approx. 40°)

inserts:            flat glass  
                         small lens medium  
                         fresnel lens

luminous flux :    perfect color    18 W    870 lm

## Sito lato connect several luminaires

through-wired with buried exterior  
junction box

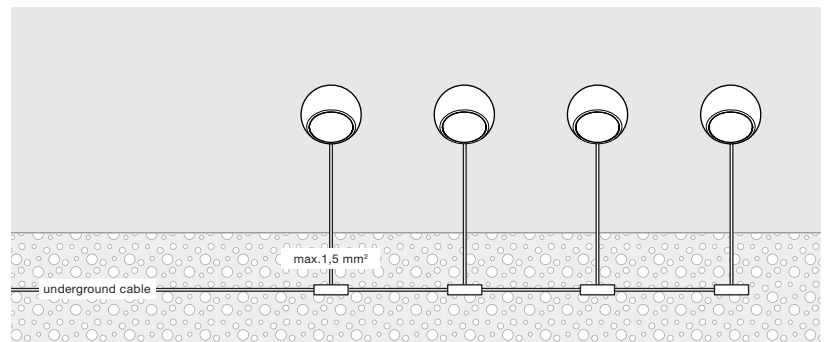

through-wired with plug in terminals

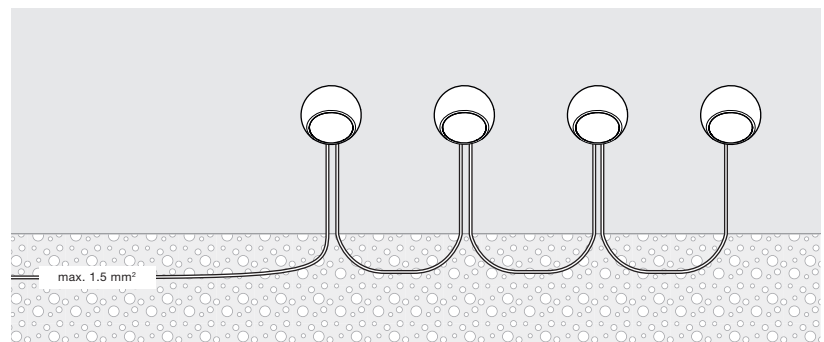

Occhio air module in switch box or  
distribution box



max. 4 luminaires

