

Sito basso datasheet

LED floor luminaire for exterior with spherical head and single-sided light output. Available either with spherical glass (Sito) or flat glass (Sito R) with internal lens, the lighting effect can be decided upon purchase. Thanks to the almost invisible division of the two halves of the sphere, it is pivotable by up to 45° on the vertical axis.

The floor luminaire complies with protection class IP65 and is thus dust-tight and jet-proof. Thanks to the optional ground anchoring, it can be also mounted on loose ground. Connection to 230 V (AC) mains voltage; dimmable via trailing-edge phase-cut dimmer*



----- Sito with spherical glass
— Sito R with flat glass

dimensions in mm

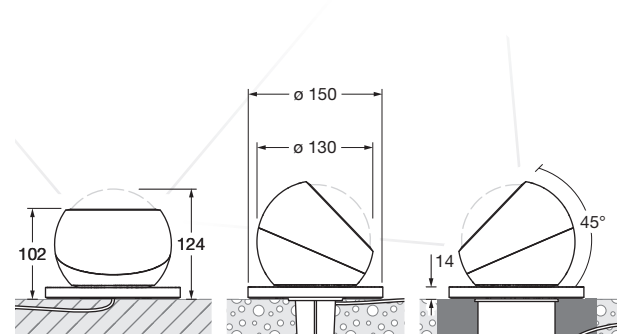

technical data Sito basso

properties	material	aluminium, painted, optical glass
	turning range	360° (with stop and fixable)
	movability head	45° (with stop)
	weight	3.2 kg (earth spike 0.6 kg, ground anchor 2.3 kg)
surface	head	matt white, glossy white, matt black
	base	matt white, matt black
VOLT light engine	average life time	> 40.000 hrs
	energy efficiency class (luminous efficiency)	G (72 lm / W)
	power	LED 18 W
	color rendering index	perfect color; CRI Ra 97
	color temperature (color consistency)	2700 K, 3000 K (2-step)
electricity	dimming	by trailing-edge phasecut dimmer*
	connection	230 V AC / 50 Hz
	power factor power supply (cos φ1)	0.9
	flicker / stroboscopic effect	1 (PstLM) / 0.9 (SVM)
	permitted operating conditions	-20°C to +40°C

* For a list of compatible dimmers, see www.occhio.de/dim_en

Sito basso Sito lighting effects

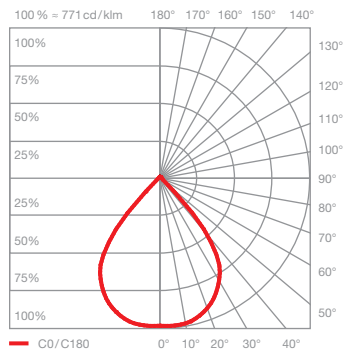

C80 contour

scattered light with contour beam angle
(approx. 80°)

inserts: spherical glass
 small lens medium

luminous flux : perfect color 18 W 1100 lm

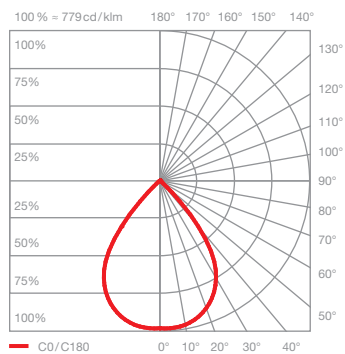

S80 soft

scattered light with soft contour beam angle
(approx. 80°)

inserts: spherical glass
 small lens medium
 soft edge glass

luminous flux : perfect color 18 W 980 lm

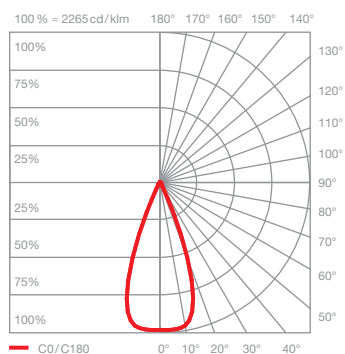
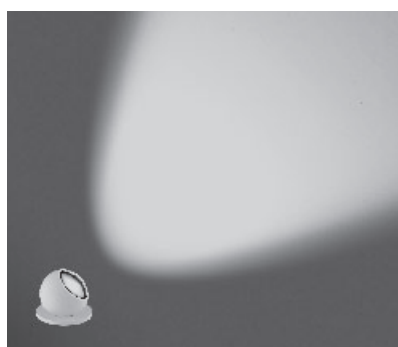

S40 soft

scattered light with soft contour beam angle
(approx. 40°)

inserts: spherical glass
 small lens medium
 fresnel lens

luminous flux : perfect color 18 W 870 lm

Sito basso Sito R lighting effects

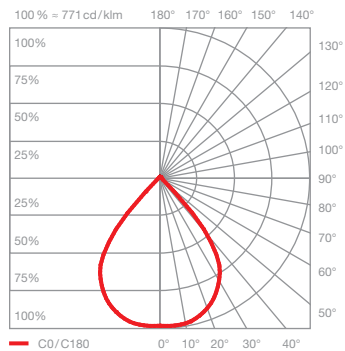
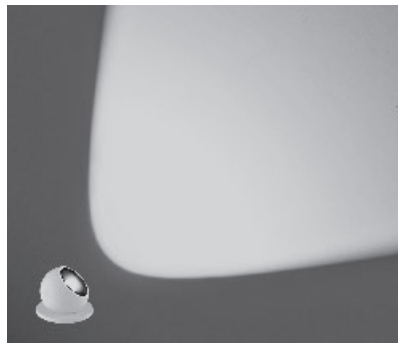

C80 contour

scattered light with contour beam angle
(approx. 80°)

inserts: flat glass
 small lens medium

luminous flux : perfect color 18 W 1100 lm

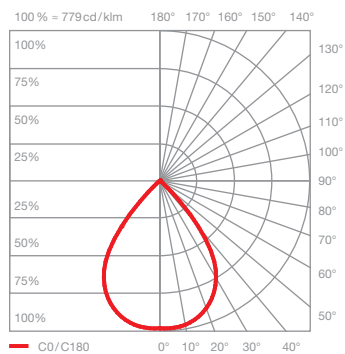

S80 soft

scattered light with soft contour beam angle
(approx. 80°)

inserts: flat glass
 small lens medium
 soft edge glass

luminous flux : perfect color 18 W 980 lm

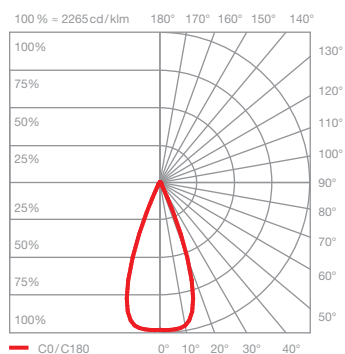
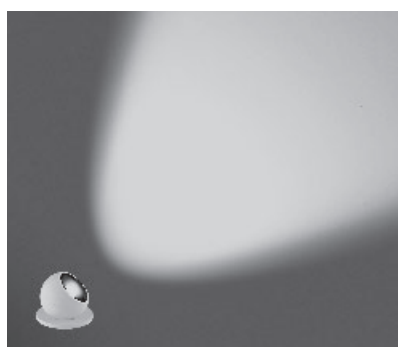

S40 soft

scattered light with soft contour beam angle
(approx. 40°)

inserts: flat glass
 small lens medium
 fresnel lens

luminous flux : perfect color 18 W 870 lm

Sito basso mounting accessories

ground anchor for potting in concrete

width: 95 mm
height: 400 mm
depth : 95 mm

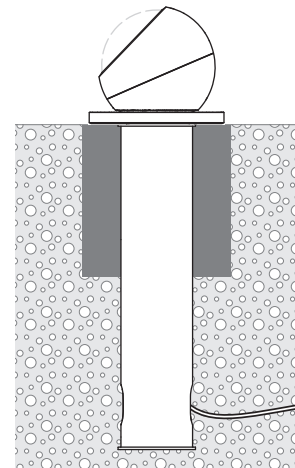
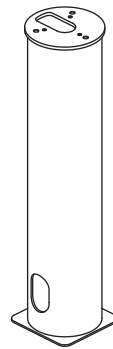

earth spike mounting in loose ground (e.g. earth, gravel)

height: 267 mm
diameter: 60 mm

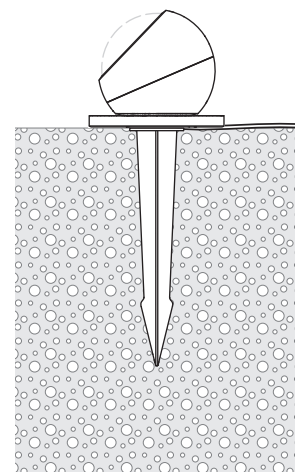

Sito basso connect several luminaires

through-wired with buried exterior
junction box

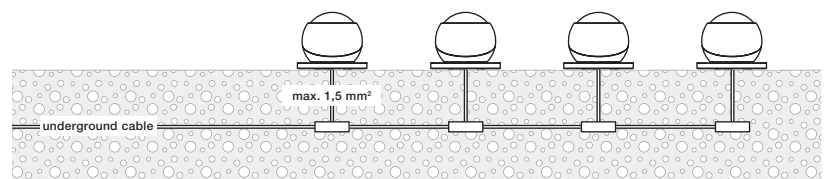

through-wired with plug in terminals

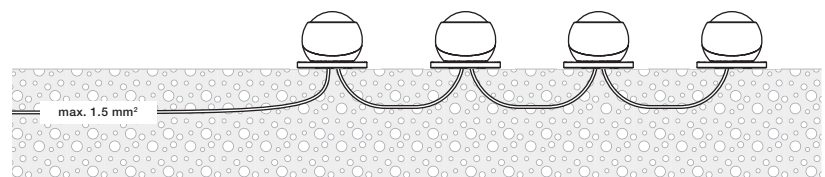

Occhio air module in switch box or
distribution box



max. 4 luminaires

