

Più piano v VOLT datasheet

LED recessed spotlight (downlight non-tiltable) with magnetically attached covers (round & square) for flush mounting in hollow ceilings or solid ceilings with ceiling box. The spotlight is mounted with a simple tension spring mechanism and requires no screw fittings.

Choice of lens design (Più) or flat cone glass with interior lens (Più R). Version for connection to 230-volt AC at 50 hertz power supply, can be dimmed using trailing-edge phase cut dimmer. * Optional inserts allow the lighting effect to be changed at any time with a simple mechanism; dichroic color filters can also be used, VOLT light engine can be exchanged.

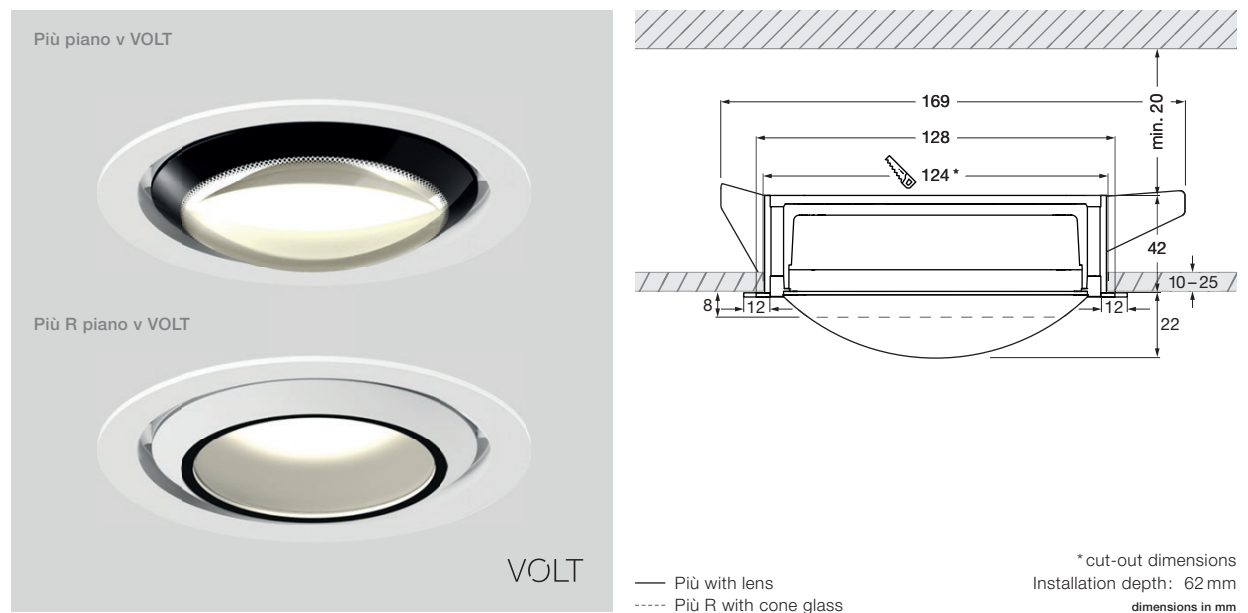

technical data Più piano v VOLT

properties	material	aluminium, brass, steel – chrome-plated or painted, optical plastic, glass
	weight	0.8 kg
surface	head / tube	matt white, matt black
	lens	matt white, matt black (lens edge)
	cone glass	rose gold, bronze, shiny chrome, matt chrome, matt white, matt black, phantom, black phantom
	cover	matt gold, rose gold, bronze, shiny chrome, matt chrome, glossy white, matt white, matt black, phantom, black phantom
Occhio light module	average life time	> 40.000 hrs
	energy efficiency class (luminous efficiency)	G (58 lm / W)
	power	LED 26 W (switchable 26 W / 18 W / 13 W)
	color rendering index	perfect color; CRI Ra 97
	color temperature (color consistency)	2700 K, 3000 K (2-step)
electricity	dimming	by trailing-edge phase-cut dimmer*
	power supply unit	operation at 230 V AC / 50 Hz
	power factor power supply (cos φ1)	0.9
	flicker / stroboscopic effect	1 (PstLM) / 0.9 (SVM)
	permitted operating conditions	max. 30°C for indoor use only

* For a list of compatible dimmers, see www.occhio.de/dim_en

Più piano v VOLT

Più piano v VOLT
head H38 mm, ϕ 125 mm

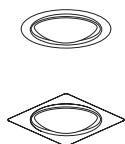

mounting tube with cover

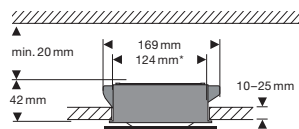

hollow ceiling

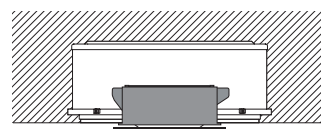

concrete ceiling
(Kaiser HaloX 250 with mineral-fibre board)
driver max. L 210 mm x W 30 mm

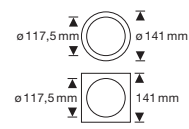

cover

* cut-out dimensions

Più piano v VOLT

through-wiring

Più piano v VOLT

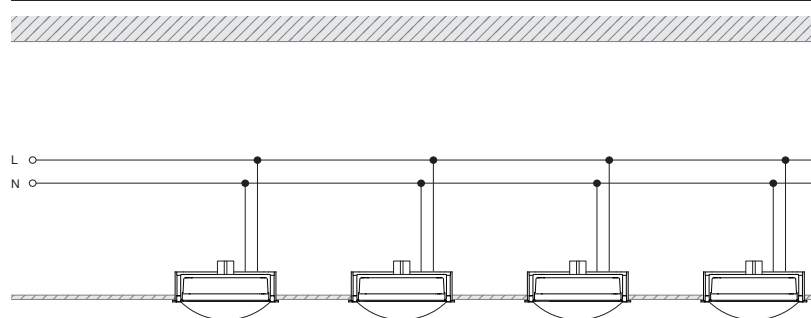

Più piano v VOLT + Occhio air module max. 5 luminaires

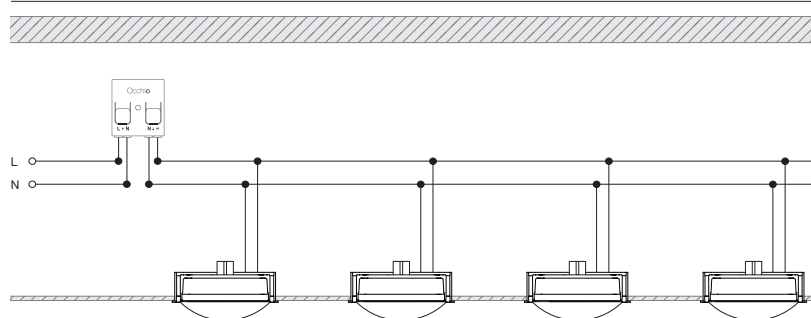

Più piano v VOLT + trailing-edge phase-cut dimmer max. number depends on the max. wattage of trailing-edge phase-cut dimmer

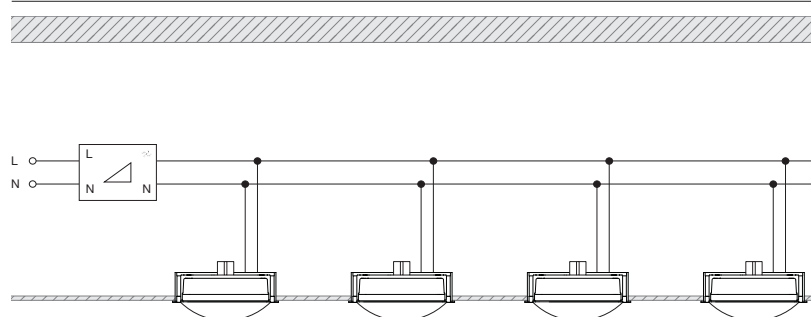

Più piano v VOLT overview optics

Più	C 80	S 100	S 80	S 60	S 40	S 30		
small lens low								
small lens medium								
satinised glass								
soft edge glass								
fresnel lens								
color filter (optional)								
lens								
Più R	B	C 100	C 80	S 100	S 80	S 60	S 40	S 30
small lens low								
small lens medium								
small lens high								
satinised glass								
soft edge glass								
fresnel lens								
color filter (optional)								
cone glass								
	diffus	100°, contour	80°, contour	100°, soft	80°, soft	60°, soft	40°, soft	30°, soft

Più piano v VOLT
Più lighting effects

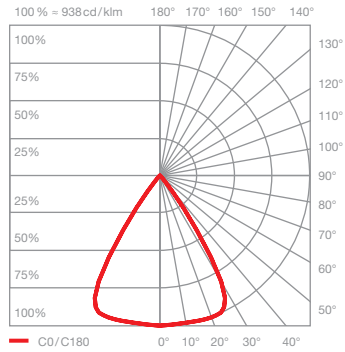
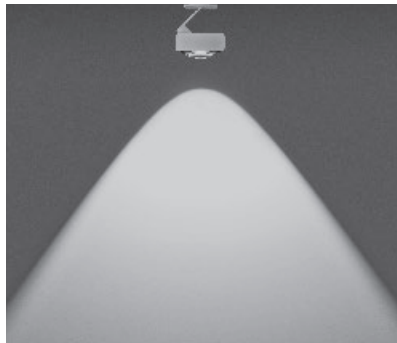

C 80 contour

scattered light with contour beam angle
(approx. 80°)

inserts: lens

luminous flux:	perfect color	26 W	1290 lm
	perfect color	18 W	970 lm
	perfect color	13 W	730 lm

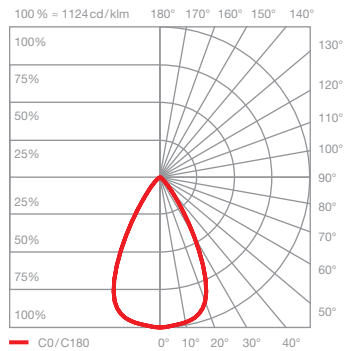
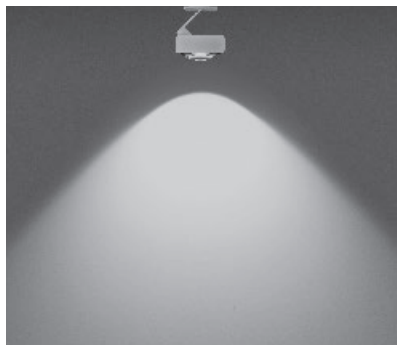

S 100 soft

scattered light with soft contour beam angle
(approx. 100°)

inserts: lens
satinised glass

luminous flux:	perfect color	26 W	1030 lm
	perfect color	18 W	780 lm
	perfect color	13 W	580 lm

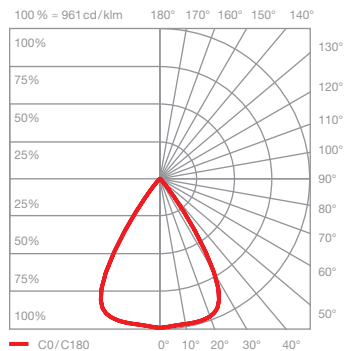
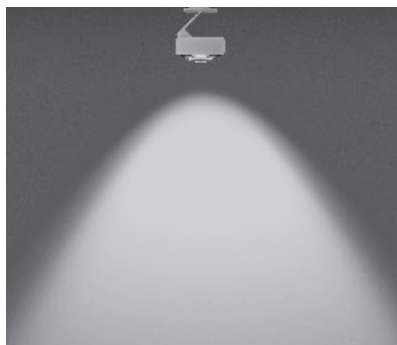

S 80 soft

scattered light with soft contour beam angle
(approx. 80°)

inserts: lens
soft edge glass

luminous flux:	perfect color	26 W	1140 lm
	perfect color	18 W	860 lm
	perfect color	13 W	640 lm

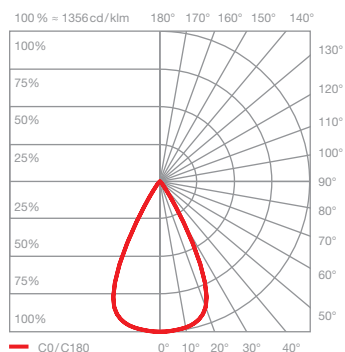
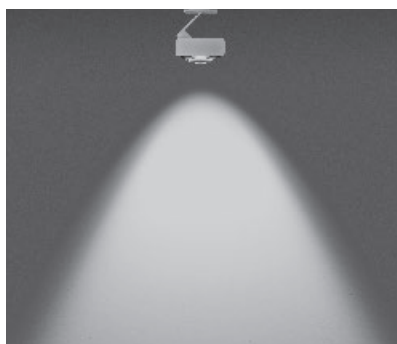

S 60 soft

scattered light with soft contour beam angle
(approx. 60°)

inserts: lens
small lens low
soft edge glass

luminous flux:	perfect color	26 W	1240 lm
	perfect color	18 W	930 lm
	perfect color	13 W	700 lm

Più piano v VOLT
Più lighting effects

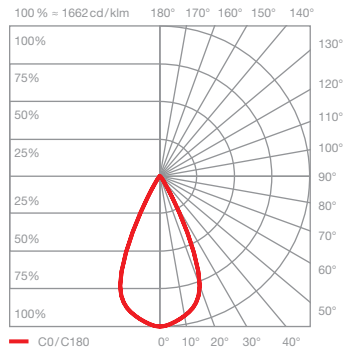
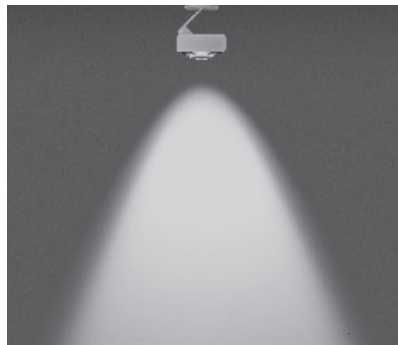

S40 soft

scattered light with soft contour beam angle (approx. 40°)

inserts: lens
small lens medium
soft edge glass

luminous flux: perfect color 26W 1280lm
perfect color 18W 960lm
perfect color 13W 720lm

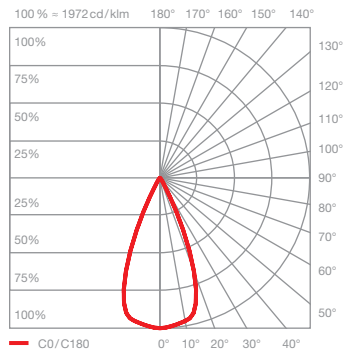

S30 soft

scattered light with soft contour beam angle (approx. 30°)

inserts: lens
small lens medium
fresnel lens

luminous flux: perfect color 26W 1270lm
perfect color 18W 950lm
perfect color 13W 710lm

Più piano v VOLT Più R lighting effects

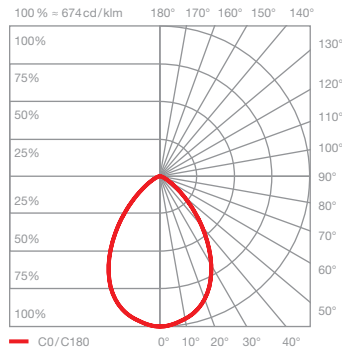
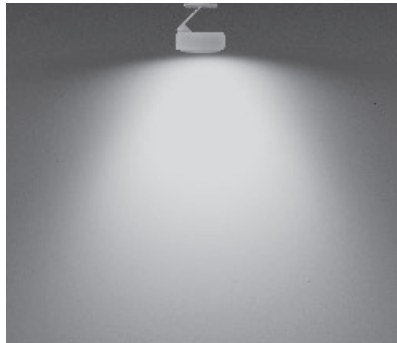

B diffus diffused light

inserts: cone glass
small lens low
satinised glass

luminous flux: perfect color 26 W 1200 lm
perfect color 18 W 900 lm
perfect color 13 W 680 lm

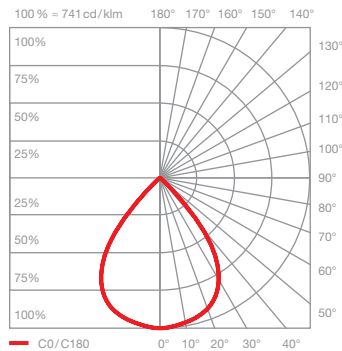
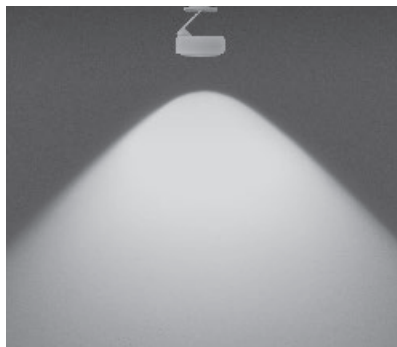

C 100 contour scattered light with contour beam angle (approx. 100°)

inserts: cone glass
small lens low

luminous flux: perfect color 26 W 1340 lm
perfect color 18 W 1000 lm
perfect color 13 W 750 lm

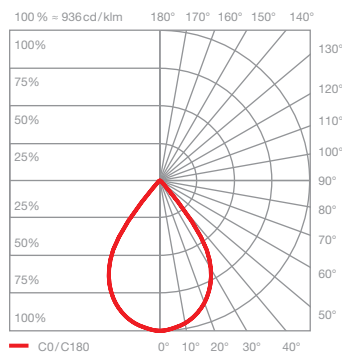
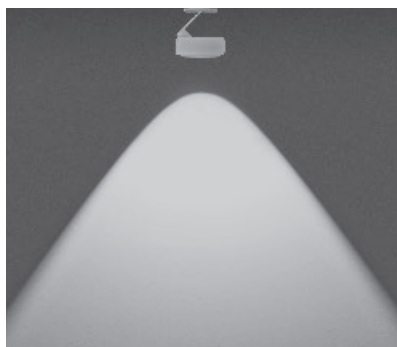

C 80 contour scattered light with contour beam angle (approx. 80°)

inserts: cone glass
small lens medium

luminous flux: perfect color 26 W 1400 lm
perfect color 18 W 1050 lm
perfect color 13 W 790 lm

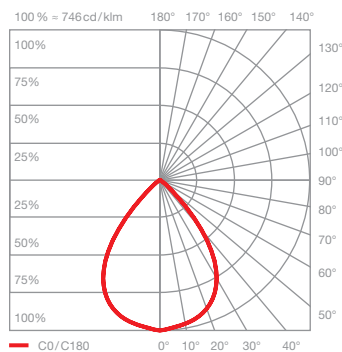
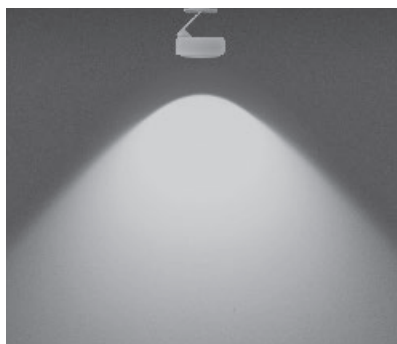

S 100 soft scattered light with soft contour beam angle (approx. 100°)

inserts: cone glass
small lens low
soft edge glass

luminous flux: perfect color 26 W 1210 lm
perfect color 18 W 910 lm
perfect color 13 W 680 lm

Più piano v VOLT Più R lighting effects

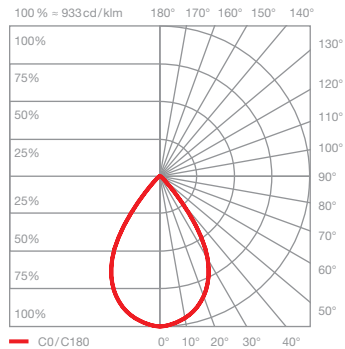
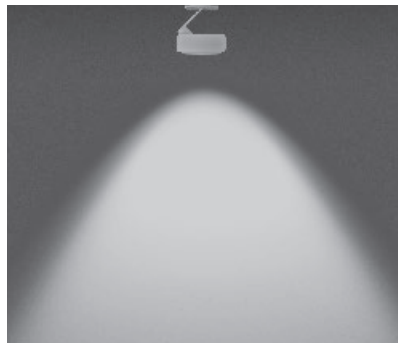

S80 soft

scattered light with soft contour beam angle (approx. 80°)

inserts: cone glass
small lens medium
soft edge glass

luminous flux: perfect color 26W 1250lm
perfect color 18W 940lm
perfect color 13W 710lm

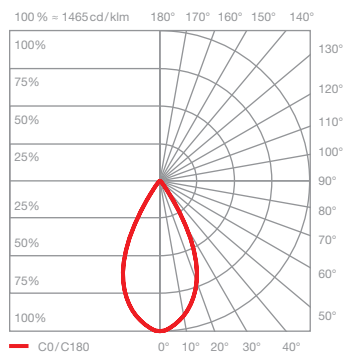
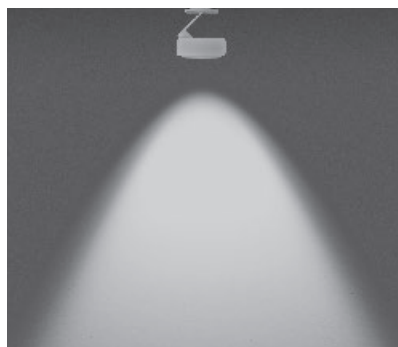

S60 soft

scattered light with soft contour beam angle (approx. 60°)

inserts: cone glass
small lens high
soft edge glass

luminous flux: perfect color 26W 1220lm
perfect color 18W 920lm
perfect color 13W 690lm

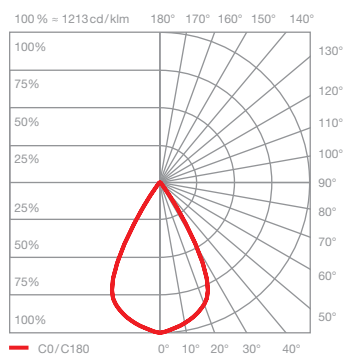
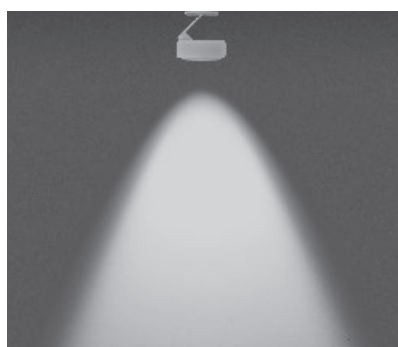

S40 soft

scattered light with soft contour beam angle (approx. 40°)

inserts: cone glass
small lens medium
fresnel lens

luminous flux: perfect color 26W 1220lm
perfect color 18W 920lm
perfect color 13W 690lm

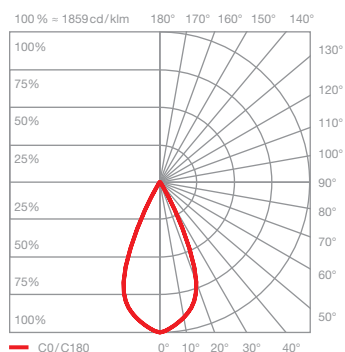

S30 soft

scattered light with soft contour beam angle (approx. 30°)

inserts: cone glass
small lens high
fresnel lens

luminous flux: perfect color 26W 1250lm
perfect color 18W 940lm
perfect color 13W 700lm