

# K77 ADJUSTABLE

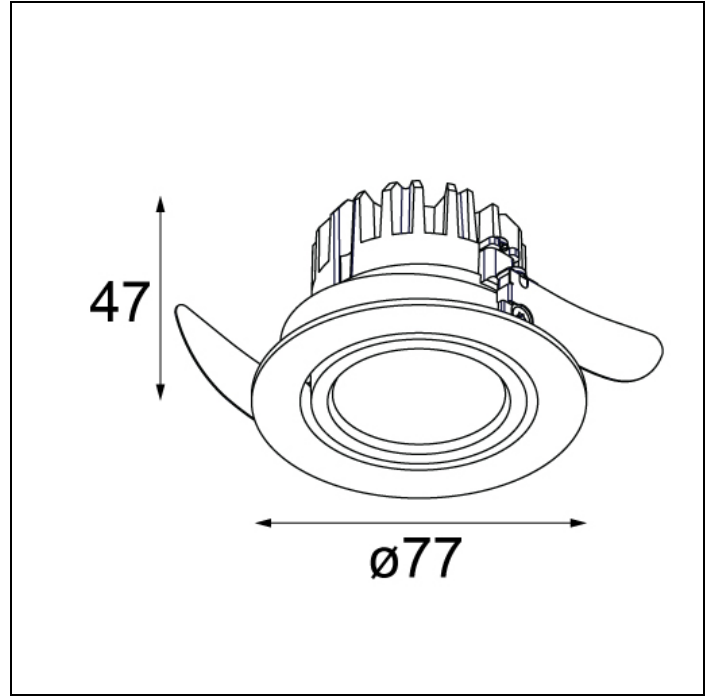
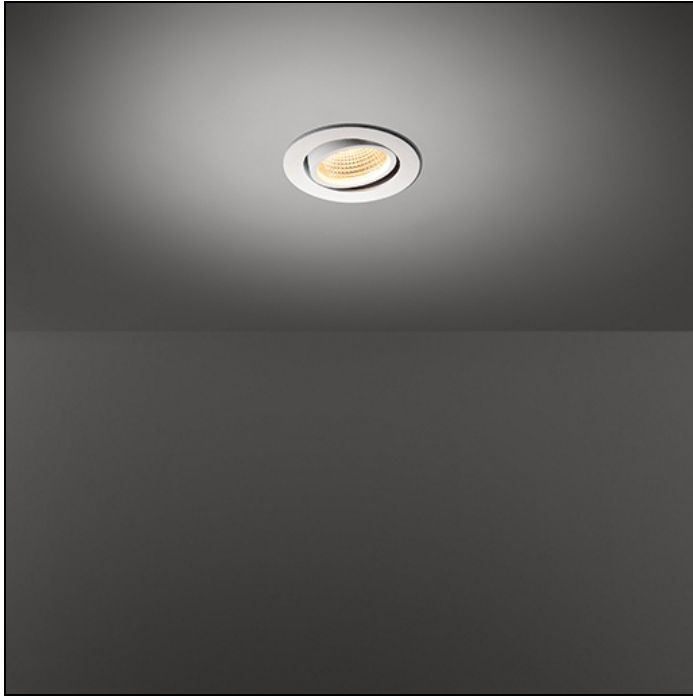

## K77 ADJUSTABLE LED GE

K77 was developed as an extension to K72. With the LED dedicated rework of the K we honour an icon. A timeless, adjustable spot for general/accent lighting product that will remain in the Modular portfolio for many years to come. Just like its K72 counterpart, K77 is available in donkey grey and white structure.

Art. Nr. 14050171

### SPECIFICATIONS

Lamp	1x LED Array	
Gear / Transfo	LED gear not incl.	
Cut-out size	ø 70 h 60	
Weight	0.21kg	
Min. Distance	0.1	
IP	IP20	
Glow Wire Test	960°	
CRI	90	
Power supply	350mA	500mA
	17.8Vf	18.4Vf
Connected load	6.2W	9.2W
Lumen	482lm	648lm
Efficacy	78lm/W	70lm/W
UGR	19	20
Adjustability	h 360° v -30°/+30°	
Remark	! 3500K on request	

	WARM WHITE 2700K / CRI 90+			WARM WHITE 3000K / CRI 90+			NEUTRAL WHITE 4000K / CRI 90+		
	SPOT 15°	MEDIUM 25°	FLOOD 40°	SPOT 15°	MEDIUM 25°	FLOOD 40°	SPOT 15°	MEDIUM 25°	FLOOD 40°
black struc	14050032	14050132	14050232	14050332	14050432	14050532	14050632	14050732	14050832
donkey grey struc	14050071	14050171	14050271	14050371	14050471	14050571	14050671	14050771	14050871
white struc	14050009	14050109	14050209	14050309	14050409	14050509	14050609	14050709	14050809

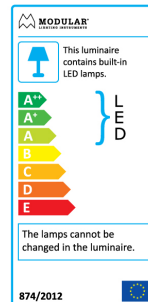

This label is available in other languages:  
<http://supemodular.com/assets/TYPE2.pdf>

## K77 ADJUSTABLE LED GE

### ACCESSORIES

#### HUE-DEVICE

70000615	PHILIPS HUE TAP SWITCH
70000614	PHILIPS HUE DIMMER SWITCH
70000847	PHILIPS HUE SENSOR

#### HUE-BRIDGE

70000616	PHILIPS HUE BRIDGE EU
70000617	PHILIPS HUE BRIDGE UK

#### HUE-MODULE

13190030	MODULAR CONNECTED 1-10V WHITE COMPONENT
----------	---

#### CONBOX

10889830	CONBOX 190X192X130X256
----------	------------------------

#### GYPKIT

12290130	GYPKIT 190X190 - Ø70
----------	----------------------

#### DRIVER-LED

12403730	LED GEAR 350MA 15W
----------	--------------------