

SMART CAKE 115 ADJUSTABLE LED GE

Smart cake is part of the Smart family. This family's styling is based on our most popular iconic designs. Its gently sloping sides ensure a soft distribution of light. Since its introduction in 2010, Smart has become an extensive portfolio with a broad range of accessories. Concretely this means that the luminaires consist of a light source (LED, halogen), which can be combined with one of three trims to suit your needs. The new spotlights can be combined with Smart mask, Smart surface box or surface tubed to form the perfect solution for any interior. Choose a white, black or gold finishing. Also available in different sizes, fix and adjustable, IP version, ...

Art. Nr. 12771332

SPECIFICATIONS

Lamp	1x LED Array		
Gear / Transfo	LED gear not incl.		
Cut-out size	ø 108 h 100		
Weight	0.488kg		
Min. Distance	0.1		
IP	IP20		
Glow Wire Test	960°		
Lifetime	L80 B20 @ 50.000 hrs		
CRI	90		
Power supply	350mA 17.8Vf	500mA 18.4Vf	700mA 19.3Vf
Connected load	6.2W	9.2W	13.4W
Lumen	332lm	446lm	573lm
Efficacy	54lm/W	48lm/W	43lm/W
UGR	4	5	6
Adjustability	h 355° v 30°		
Remark	! 3500K on request ! can be combined with Smart mask ! can be combined with Smart surface box & surface tubed (surface only)		

	WARM WHITE 2700K / CRI 90+			NEUTRAL WHITE 4000K / CRI 90+			WARM WHITE 3000K / CRI 90+		
	MEDIUM 25°	SPOT 15°	FLOOD 40°	MEDIUM 25°	SPOT 15°	FLOOD 40°	SPOT 15°	MEDIUM 25°	FLOOD 40°
black struc	12771032	12771232	12771332	12771132	12771732	12771832	12771432	12771532	12771632
gold	12771046	12771246	12771346	12771146	12771746	12771846	12771446	12771546	12771646
white struc	12771009	12771209	12771309	12771109	12771709	12771809	12771409	12771509	12771609



This label is available in other languages:
<http://supmodular.com/assets/TYPE2.pdf>



Modular reserves the right to alter material, dimensions and characteristics without prior notice. Lighting technology changes rapidly. Latest datasheet and documentation available on www.supermodular.com.

SMART CAKE 115 ADJUSTABLE LED GE

ACCESSORIES

HUE-DEVICE

70000615	PHILIPS HUE TAP SWITCH
70000847	PHILIPS HUE SENSOR
70000614	PHILIPS HUE DIMMER SWITCH

HUE-MODULE

13190030	MODULAR CONNECTED 1-10V WHITE COMPONENT
----------	---

HUE-BRIDGE

70000617	PHILIPS HUE BRIDGE UK
70000616	PHILIPS HUE BRIDGE EU

SURFACE-TUBED

13140309	SMART SURFACE TUBED 115 LED DALI GI WHITE STRUC
13140332	SMART SURFACE TUBED 115 LED DALI GI BLACK STRUC
13140324	SMART SURFACE TUBED 115 LED DALI GI BRUSHED ALU
13140209	SMART SURFACE TUBED 115 LED 1-10V/PUSHDIM GI WHITE STRUC
13140232	SMART SURFACE TUBED 115 LED 1-10V/PUSHDIM GI BLACK STRUC
13140224	SMART SURFACE TUBED 115 LED 1-10V/PUSHDIM GI BRUSHED ALU
13140109	SMART SURFACE TUBED 115 LED TRE DIM GI WHITE STRUC
13140132	SMART SURFACE TUBED 115 LED TRE DIM GI BLACK STRUC
13140124	SMART SURFACE TUBED 115 LED TRE DIM GI BRUSHED ALU

CONBOX

10889830	CONBOX 190X192X130X256
----------	------------------------

GYPKIT

12290530	GYPKIT 190X190 - Ø108
----------	-----------------------

RECESSED-FRAME

12810230	RECESSED RING Ø127 H100
----------	-------------------------

SURFACE-BOX

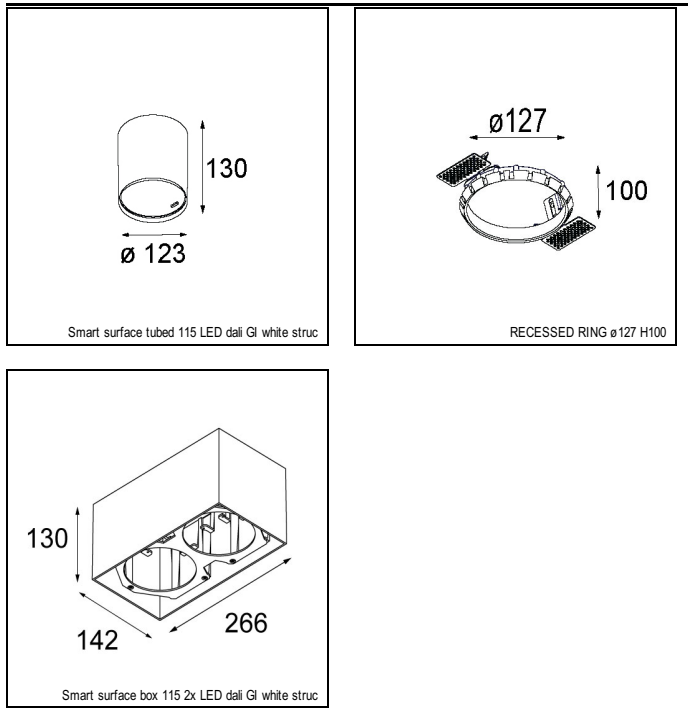

ACCESSORIES

SURFACE-BOX

12801109	SMART SURFACE BOX 115 2X LED 1-10V/PUSHDIM GI WHITE STRUC
12801132	SMART SURFACE BOX 115 2X LED 1-10V/PUSHDIM GI BLACK STRUC
12801009	SMART SURFACE BOX 115 2X LED TRE DIM GI WHITE STRUC
12801032	SMART SURFACE BOX 115 2X LED TRE DIM GI BLACK STRUC
12800209	SMART SURFACE BOX 115 1X LED DALI GI WHITE STRUC
12800232	SMART SURFACE BOX 115 1X LED DALI GI BLACK STRUC
12800109	SMART SURFACE BOX 115 1X LED 1-10V/PUSHDIM GI WHITE STRUC
12800132	SMART SURFACE BOX 115 1X LED 1-10V/PUSHDIM GI BLACK STRUC
12800009	SMART SURFACE BOX 115 1X LED TRE DIM GI WHITE STRUC
12800032	SMART SURFACE BOX 115 1X LED TRE DIM GI BLACK STRUC

MASK

12810132	SMART MASK 115 2X BLACK STRUC
12810109	SMART MASK 115 2X WHITE STRUC
12810146	SMART MASK 115 2X GOLD
12810032	SMART MASK 115 1X BLACK STRUC
12810009	SMART MASK 115 1X WHITE STRUC
12810046	SMART MASK 115 1X GOLD

