

SMART CAKE 115 IP54 LED GE

Smart cake is part of the Smart family. This family's styling is based on our most popular iconic designs. Its gently sloping sides ensure a soft distribution of light. Since its introduction in 2010, Smart has become an extensive portfolio with a broad range of accessories. Concretely this means that the luminaires consist of a light source (LED, halogen), which can be combined with one of three trims to suit your needs. The new spotlights can be combined with Smart mask, Smart surface box or surface tubed to form the perfect solution for any interior. Choose a white, black or gold finishing. Also available in different sizes, fix and adjustable, IP version, ...

Art. Nr. 12742132

SPECIFICATIONS

Lamp	1x LED Array		
Gear / Transfo	LED gear not incl.		
Cut-out size	ø 108 h 100		
Weight	0.53kg		
Min. Distance	0.1		
IP	IP54		
Glow Wire Test	960°		
Lifetime	L80 B20 @ 50.000 hrs		
CRI	90		
Power supply	350mA 31Vf	500mA 32Vf	700mA 34Vf
Connected load	11W	16.25W	23.6W
Lumen	853lm	1171lm	1557lm
Efficacy	78lm/W	72lm/W	66lm/W
UGR	12	13	14
Adjustability	Not Applicable		
Remark	! 3500K on request ! can be combined with Smart mask ! can be combined with Smart surface box & surface tubed (surface/suspension)		

	WARM WHITE 2700K / CRI 90+			NEUTRAL WHITE 4000K / CRI 90+			WARM WHITE 3000K / CRI 90+		
	MEDIUM 25°	SPOT 15°	FLOOD 40°	MEDIUM 25°	SPOT 15°	FLOOD 40°	SPOT 15°	MEDIUM 25°	FLOOD 40°
black struc	12742032	12742232	12742332	12742132	12742732	12742832	12742432	12742532	12742632
gold	12742046	12742246	12742346	12742146	12742746	12742846	12742446	12742546	12742646
white struc	12742009	12742209	12742309	12742109	12742709	12742809	12742409	12742509	12742609



This label is available in other languages:
<http://supmodular.com/assets/TYPE2.pdf>



SMART CAKE 115 IP54 LED GE

ACCESSORIES

CONBOX

10889830 | CONBOX 190X192X130X256

RECESSED-FRAME

12810230 | RECESSED RING Ø127 H100

SURFACE-TUBED

13140309	SMART SURFACE TUBED 115 LED DALI GI WHITE STRUC
13140332	SMART SURFACE TUBED 115 LED DALI GI BLACK STRUC
13140324	SMART SURFACE TUBED 115 LED DALI GI BRUSHED ALU
13140209	SMART SURFACE TUBED 115 LED 1-10V/PUSHDIM GI WHITE STRUC
13140232	SMART SURFACE TUBED 115 LED 1-10V/PUSHDIM GI BLACK STRUC
13140224	SMART SURFACE TUBED 115 LED 1-10V/PUSHDIM GI BRUSHED ALU
13140109	SMART SURFACE TUBED 115 LED TRE DIM GI WHITE STRUC
13140132	SMART SURFACE TUBED 115 LED TRE DIM GI BLACK STRUC
13140124	SMART SURFACE TUBED 115 LED TRE DIM GI BRUSHED ALU
13141309	SMART SURFACE TUBED SUSPENSION 115 LED DALI GI WHITE STRUC
13141332	SMART SURFACE TUBED SUSPENSION 115 LED DALI GI BLACK STRUC
13141324	SMART SURFACE TUBED SUSPENSION 115 LED DALI GI BRUSHED ALU
13141209	SMART SURFACE TUBED SUSPENSION 115 LED 1-10V/PUSHDIM GI WHITE STRUC
13141232	SMART SURFACE TUBED SUSPENSION 115 LED 1-10V/PUSHDIM GI BLACK STRUC
13141224	SMART SURFACE TUBED SUSPENSION 115 LED 1-10V/PUSHDIM GI BRUSHED ALU
13141109	SMART SURFACE TUBED SUSPENSION 115 LED TRE DIM GI WHITE STRUC
13141132	SMART SURFACE TUBED SUSPENSION 115 LED TRE DIM GI BLACK STRUC
13141124	SMART SURFACE TUBED SUSPENSION 115 LED TRE DIM GI BRUSHED ALU

GYPKIT

12290530 | GYPKIT 190X190 - Ø108

MASK

12810132	SMART MASK 115 2X BLACK STRUC
12810109	SMART MASK 115 2X WHITE STRUC
12810146	SMART MASK 115 2X GOLD
12810032	SMART MASK 115 1X BLACK STRUC

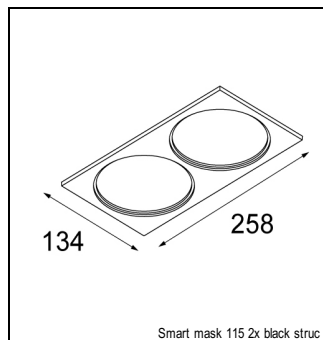
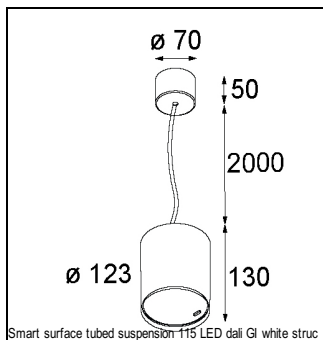
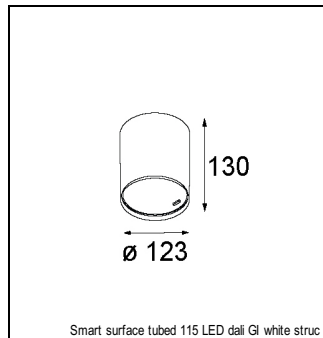
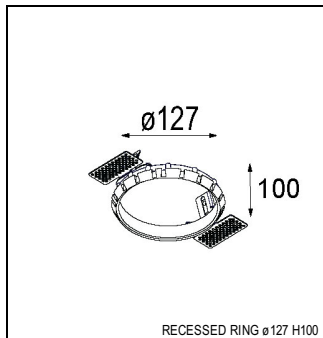

ACCESSORIES

MASK

12810009	SMART MASK 115 1X WHITE STRUC
12810046	SMART MASK 115 1X GOLD

HUE-DEVICE

70000847	PHILIPS HUE SENSOR
70000615	PHILIPS HUE TAP SWITCH
70000614	PHILIPS HUE DIMMER SWITCH

HUE-MODULE

13190030	MODULAR CONNECTED 1-10V WHITE COMPONENT
----------	---

HUE-BRIDGE

70000617	PHILIPS HUE BRIDGE UK
70000616	PHILIPS HUE BRIDGE EU