

SMART KUP 82 IP54 LED GE

Smart kup is one of the 3 forms of the Smart family. The cone of the Smart kup ends in a fine trim. A trim particular Modular. The same subtle trim is used in several other Modular luminaires. The Smart family's styling is based on our most popular designs. Concretely this means that the luminaires consist of a light source (LED or halogen) which can be combined with one of three trims to suit your needs. The new spotlights can be combined with Smart mask, Smart surface box or surface tubed to form the perfect solution for any interior. Choose a white, black or gold finishing. Also available in different sizes, fix and adjustable, IP version, ...

Art. Nr. 12472032

SPECIFICATIONS

Lamp	1x LED Array	
Gear / Transfo	LED gear not incl.	
Cut-out size	ø 70 h 60	
Weight	0.36kg	
Min. Distance	0.1 m	
IP	IP54	
Glow Wire Test	960°	
Lifetime	L80 B20 @ 50.000 hrs	
CRI	90	
Power supply	500mA	350mA
	18.4Vf	17.8Vf
Connected load	9.2W	6.2W
Lumen	586lm	436lm
Efficacy	64lm/W	70lm/W
UGR	15	14
Adjustability	Not Applicable	
Remark	! 3500K on request ! can be combined with Smart mask ! can be combined with Smart surface box & surface tubed (surface/suspension)	

	WARM WHITE 2700K / CRI 90+			NEUTRAL WHITE 4000K / CRI 90+			WARM WHITE 3000K / CRI 90+		
	MEDIUM 25°	FLOOD 40°	SPOT 15°	FLOOD 40°	MEDIUM 25°	SPOT 15°	MEDIUM 25°	FLOOD 40°	SPOT 15°
black struc	12472032	12472132	12472632	12472232	12472532	12472832	12472332	12472432	12472732
gold	12472046	12472146	12472646	12472246	12472546	12472846	12472346	12472446	12472746
white struc	12472009	12472109	12472609	12472209	12472509	12472809	12472309	12472409	12472709



This label is available in other languages:
<http://supmodular.com/assets/TYPE2.pdf>



SMART KUP 82 IP54 LED GE

ACCESSORIES

CONBOX

10889830 | CONBOX 190X192X130X256

SURFACE-TUBED

12842409	SMART SURFACE TUBED SUSPENSION 82 XL LED DALI GI WHITE STRUC
12842432	SMART SURFACE TUBED SUSPENSION 82 XL LED DALI GI BLACK STRUC
12842424	SMART SURFACE TUBED SUSPENSION 82 XL LED DALI GI BRUSHED ALU
12842309	SMART SURFACE TUBED SUSPENSION 82 XL LED 1-10V/PUSHDIM GI WHITE STRUC
12842332	SMART SURFACE TUBED SUSPENSION 82 XL LED 1-10V/PUSHDIM GI BLACK STRUC
12842324	SMART SURFACE TUBED SUSPENSION 82 XL LED 1-10V/PUSHDIM GI BRUSHED ALU
12842209	SMART SURFACE TUBED SUSPENSION 82 XL LED TRE DIM GI WHITE STRUC
12842232	SMART SURFACE TUBED SUSPENSION 82 XL LED TRE DIM GI BLACK STRUC
12842224	SMART SURFACE TUBED SUSPENSION 82 XL LED TRE DIM GI BRUSHED ALU
12842009	SMART SURFACE TUBED SUSPENSION 82 LARGE LED GI WHITE STRUC
12842032	SMART SURFACE TUBED SUSPENSION 82 LARGE LED GI BLACK STRUC
12842024	SMART SURFACE TUBED SUSPENSION 82 LARGE LED GI BRUSHED ALU
12845009	SMART SURFACE TUBED 82 LARGE LED GE WHITE STRUC
12845032	SMART SURFACE TUBED 82 LARGE LED GE BLACK STRUC
12845024	SMART SURFACE TUBED 82 LARGE LED GE BRUSHED ALU
12844009	SMART SURFACE TUBED 82 LARGE LED GI WHITE STRUC
12844032	SMART SURFACE TUBED 82 LARGE LED GI BLACK STRUC
12844024	SMART SURFACE TUBED 82 LARGE LED GI BRUSHED ALU

GYPKIT

12291030 | GYPKIT 210X190-2XØ70 R35-88
12290130 | GYPKIT 190X190 - Ø70

RECESSED-FRAME

12500230 | SMART RECESSED RING 82

MASK

12500132 | SMART MASK 82 2X BLACK STRUC
12500109 | SMART MASK 82 2X WHITE STRUC
12500146 | SMART MASK 82 2X GOLD

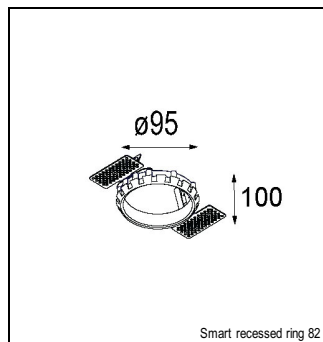
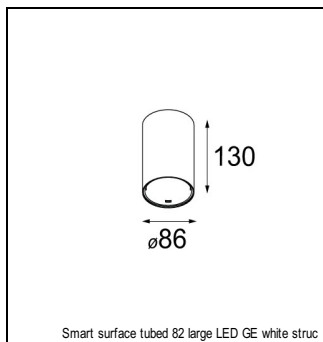
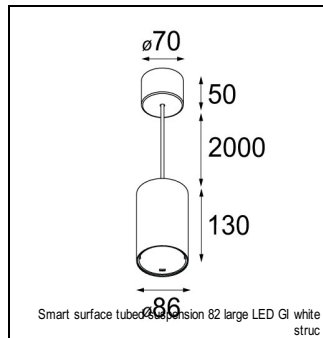
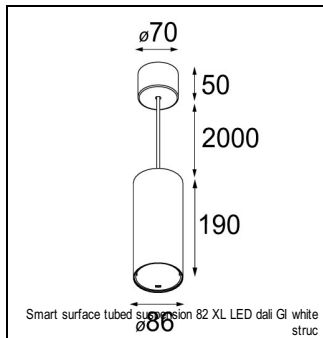

ACCESSORIES

MASK

12500032 | SMART MASK 82 1X BLACK STRUC
12500009 | SMART MASK 82 1X WHITE STRUC
12500046 | SMART MASK 82 1X GOLD

SURFACE-BOX

12515109 | SMART SURFACE BOX 82 2X LED 1-10V/PUSHDIM GI WHITE STRUC
12515132 | SMART SURFACE BOX 82 2X LED 1-10V/PUSHDIM GI BLACK STRUC
12515009 | SMART SURFACE BOX 82 2X LED TRE DIM GI WHITE STRUC
12515032 | SMART SURFACE BOX 82 2X LED TRE DIM GI BLACK STRUC
12514109 | SMART SURFACE BOX 82 1X LED 1-10V/PUSHDIM GI WHITE STRUC
12514132 | SMART SURFACE BOX 82 1X LED 1-10V/PUSHDIM GI BLACK STRUC
12514009 | SMART SURFACE BOX 82 1X LED TRE DIM GI WHITE STRUC
12514032 | SMART SURFACE BOX 82 1X LED TRE DIM GI BLACK STRUC

HUE-DEVICE

70000847 | PHILIPS HUE SENSOR
70000615 | PHILIPS HUE TAP SWITCH
70000614 | PHILIPS HUE DIMMER SWITCH

HUE-BRIDGE

70000616 | PHILIPS HUE BRIDGE EU
70000617 | PHILIPS HUE BRIDGE UK

HUE-MODULE

13190030 | MODULAR CONNECTED 1-10V WHITE COMPONENT

