

A-Tube Nano Duo,  
Design by Studio Italia Design

Model A-Tube Nano Duo

Precious pins suspended from a thin cable, like magic lights floating in the space. A-Tube Nano Duo is an offshoot of A-Tube Nano with an LED light source on both ends of its thin metal body. A lightweight and linear lamp available in six finishes, which allows to create evocative and playful cluster compositions.

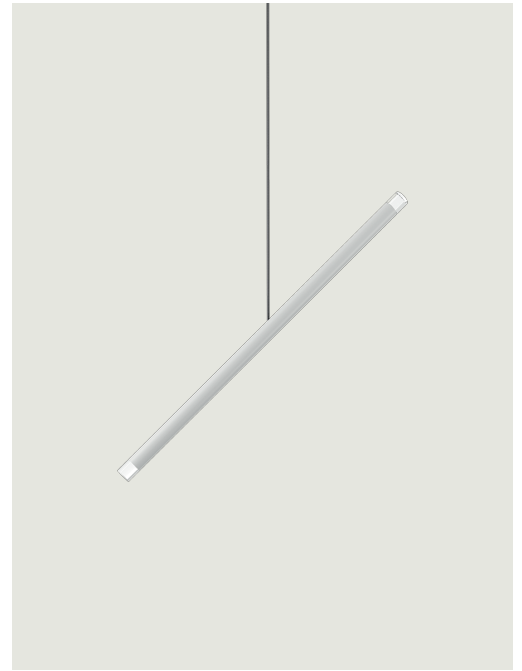

A-Tube Nano Duo

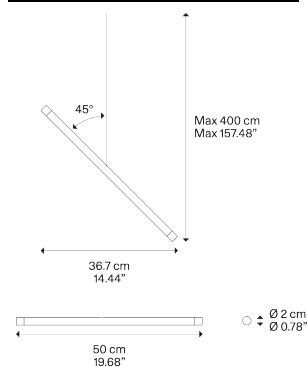







Light source







LED  
2700 K  
2 × 1 W / 300 lm  
350 mA  
CRI 90  
MacAdam 3-Step

LED and driver included

Structure: Metal

-  Matte White – 9010
-  Matte Black – 9005
-  Chrome
-  Matte Champagne
-  Gold
-  Rose Gold

Diffuser: Methacrylate

-  Clear
-  Clear
-  Clear
-  Clear
-  Clear
-  Clear

Code

- 15825 1020
- 15825 2020
- 15825 4020
- 15825 4520
- 15825 5020
- 15825 5520

Net weight: 0.21 kg

Parcels: 1



IP20

Energy Saving 

Dim Triac 



Cluster suspension lamps must be installed on a *canopy*: find out more on [lodes.com/en/canopies](https://lodes.com/en/canopies)

## A-Tube Nano Duo

## Polar diagram

LED  
2700 K  
2 × 1 W / 300 lm  
350 mA  
CRI 90  
MacAdam 3-Step

