

PALCO SURFACE (remote driver)

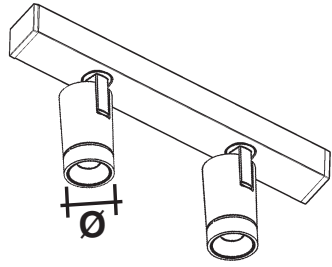

Ø	PRODUCT	ART
19 mm		QC34 - QC35
2x19 mm		QC36 - QC37
3x19 mm		QC38 - QC39
37 mm		QC40 - QC41 - QC42 - QC43
2x37 mm		QC44 - QC45
3x37mm		QC46 - QC47
51 mm		QC48 - QC49 - QC50 - QC51
2x51 mm		QC52 - QC53
3x51mm		QC54 - QC55

IT ATTENZIONE:

LA SICUREZZA DELL'APPARECCHIO E' GARANTITA SOLO CON L'USO APPROPRIATO DELLE SEGUENTI ISTRUZIONI; PERTANTO E' NECESSARIO CONSERVARLE.

EN WARNING:

THE SAFETY OF THIS FIXTURE IS GUARANTEED ONLY IF YOU COMPLY WITH THESE INSTRUCTIONS; REMEMBER TO CONSERVE IN A SAFE PLACE.

FR ATTENTION:

LA SECURITE DE L'APPAREIL N'EST GARANTIE QU'EN CAS D'UTILISATION CORRECTE DES INSTRUCTIONS SUIVANTES; IL FAUT PAR CONSEQUENT LES CONSERVER.

DE ACHTUNG:

DIE SICHERHEIT DES GERÄTES WIRD NUR DURCH SACHGEMÄSSE BEFOLGUNG NACHSTEHENDER ANWEISUNGEN GEWÄHRLEISTET; IHRE AUFBEWAHRUNG IST DESHALB SEHR WICHTIG.

NL OPGELET:

DE VEILIGHEID VAN DI ATOESTEL IS SLECHTS DAN GEGARANDEERD ALS INDIEN DE VOLGENDE INSTRUCTIES STRIKT WORDEN TOEGEPAST: DAAROM MOET MEN ZE OOK BEWAREN.

ES ATENCION:

LA SEGURIDAD DEL APARATO SE GARANTIZA SOLO CUMPLIENDO CUIDADOSAMENTE LAS SIGUIENTES INSTRUCCIONES; POR ELLO, ES NECESARIO CONSERVARLAS.

DA BEMÆRK:

SIKKERHEDEN VED BRUG AF ARMATURET KAN KUN GARANTERES, HVIS DISSE ANVISNINGER FØLGES; SØRG DERFOR FOR AT GEMME DEM.

NO ADVARSEL:

SIKKERHETEN TIL DETTE APPARATET GARANTERES KUN HVIS DU OVERHOLDER DISSE INSTRUKSJONENE; HUSK Å OPPBEVARE DEM PÅ ET TRYGT STED.

SV OBSERVERA!

UTRUSTNINGENS SÄKERHET KAN ENDAST GARANTERAS OM DESSA ANVISNINGAR RESPEKTERAS I DETALJ. SPARA DÄRFÖR DESSA ANVISNINGAR FÖR FRAMTIDA KONSULTATION.

RU ВНИМАНИЕ:

МЫ ГАРАНТИРУЕМ БЕЗОПАСНУЮ ЭКСПЛУАТАЦИЮ ИЗДЕЛИЯ ТОЛЬКО ПРИ СОБЛЮДЕНИИ СЛЕДУЮЩИХ ИНСТРУКЦИЙ; С ЭТОЙ ЦЕЛЬЮ НЕОБХОДИМО СОХРАНИТЬ ДАННУЮ БРОШЮРУ.

ZH 警告

为确保该装置安全，请遵守操作指示；并于安全场所放置。

IT N.B.: DURANTE L'INSTALLAZIONE DEL SISTEMA RISPETTARE SCRUPolosAMENTE LE NORME IMPIANTISTICHE VIGENTI.

EN N.B.: WHEN INSTALLING THE SYSTEM, STRICTLY COMPLY WITH ALL REGULATIONS ON INSTALLATION IN FORCE.

FR N.B.: LORS DE L'INSTALLATION DU SYSTÈME VEUILLEZ RESPECTER RIGOREUSEMENT LES NORMES EN VIGUEUR EN LA MATIÈRE.

DE NB.: BEACHTEN SIE BEI DER INSTALLATION DES SYSTEMS GEWISSENHAFT DIE GÜLTIGEN BESTIMMUNGEN BEZÜGLICH DER ANLAGENTECHNIK.

NL N.B.: BIJ HET INSTALLEREN VAN HET SYSTEEM MOET U DE GELDEN DE INSTALLATIENORMEN STRIKT NALEVEN.

ES N.B.: DURANTE LA INSTALACIÓN DEL SISTEMA RESPETAR E SCRUPolosAMENTE LAS NORMAS DE INSTALACIÓN VIGENTES.

DA N.B.: UNDER INSTALLATION AF SYSTEMET SKAL MAN NØJE OVERHOLDE DE GÆLDENDE REGLER FOR DISSE ANLÆG.

NO N.B.: VED INSTALLASJON AV SYSTEMET SKAL ALLE FORSKRIFTER OM INSTALLASJON SOM GJELDER FØLGES STRENGT.

SV OBS! UNDER INSTALLATIONEN AV SYSTEMET SKA INSTALLATIONSFÖRESKRIFTERNA RESPEKTERAS I DETALJ.

RU ПРИМЕЧАНИЕ: В ПРОЦЕССЕ МОНТАЖА СИСТЕМЫ СТРОГО СОБЛЮДАЙТЕ НАЦИОНАЛЬНЫЕ ДЕЙСТВУЮЩИЕ НОРМАТИВЫ ПО ЭЛЕКТРОПРОВОДКЕ.

ZH 注意：在安装系统时请遵守设备的安装规定。

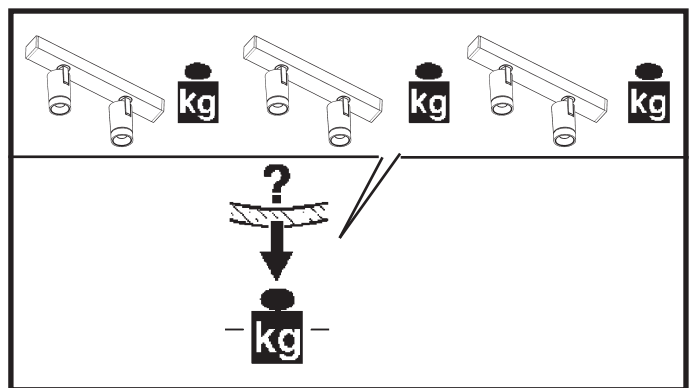
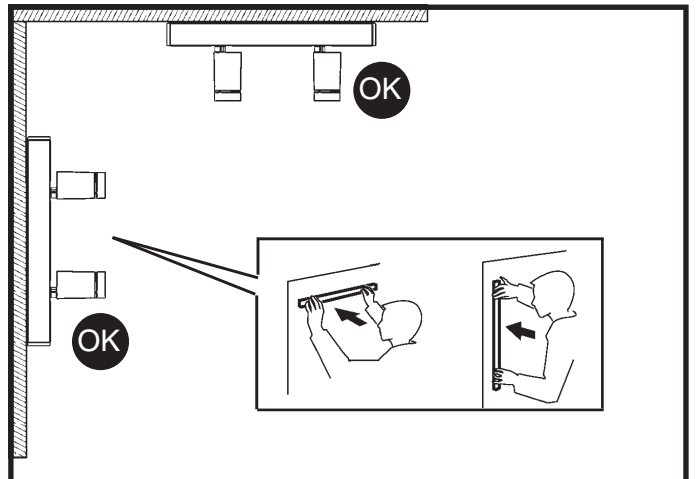
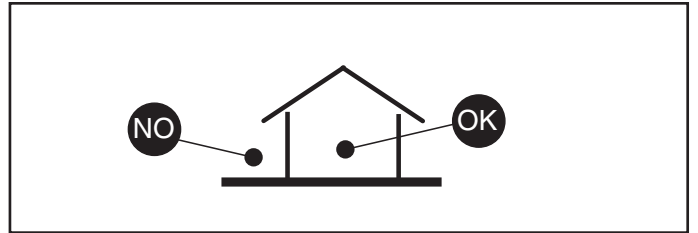

IT DA INSTALLARE SOLO AL DI FUORI DEL VOLUME DI ACCESSIBILITA'

EN TO BE INSTALLED ONLY OUTSIDE THE ACCESSIBLE SPACE

FR À INSTALLER UNIQUEMENT EN DEHORS DU VOLUME D'ACCESSIBILITÉ

DE DAS GERÄT MUSS AUSSERHALB DER REICHWEITE DES ANWENDERS INSTALLIERT WERDEN.

NL PARA INSTALAR SÓLO FUERA DEL VOLUMEN DE ACCESIBILIDAD

ES ALLEEN TE INSTALLEREN BUITEN HET TOEGANKELIJKHEIDSGEBIED

NO MÅ KUN INSTALLERES UDEN FOR ADGANGSOMFANGET

DA MÅ KUN INSTALLERES UTENFOR TILGJENGELIGHETSOMRÅDET

SV SKA ENDAST INSTALLERAS UTANFÖR ÅTKOMSTVOLYMEN

RU ПРОИЗВОДИТЬ МОНТАЖ ТОЛЬКО ЗА ПРЕДЕЛАМИ ДОСТУПНОГО ПРОСТРАНСТВА

ZH 只可安装于可用空间外侧

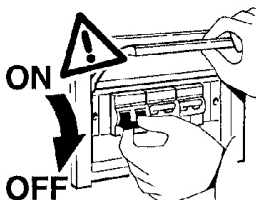



1x

ALIMENTAZIONE
POWER SUPPLY
ALIMENTATION
EINSPEISUNG
STROOMVERZORGING
ALIMENTACION
STRØMFORSYNING
STRØMFORSYNING
ELFØRSØRNING
ЭЛЕКТРОПИТАНИЕ
电源

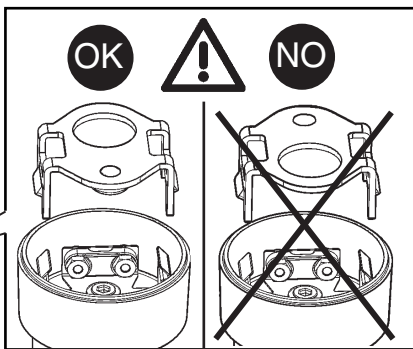
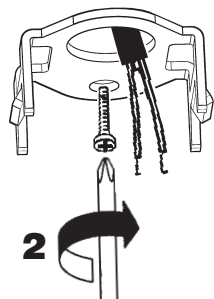
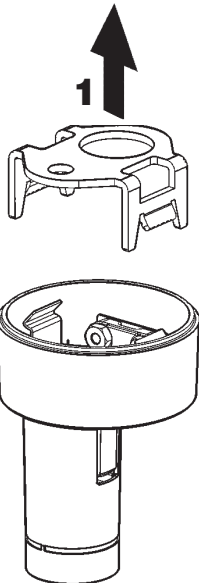
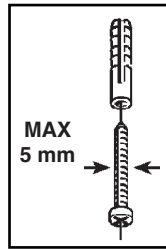
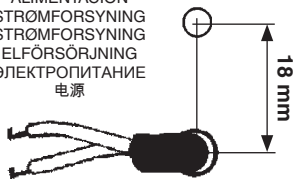

2x

3x

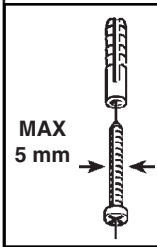
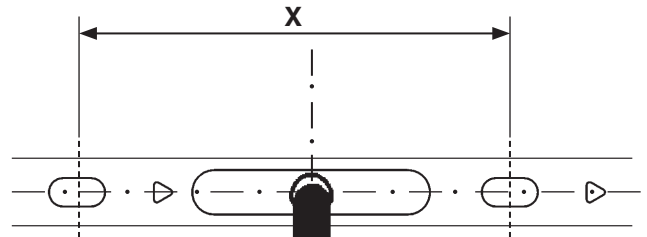
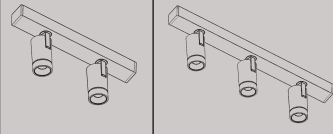

ALIMENTAZIONE
POWER SUPPLY
ALIMENTATION
EINSPEISUNG
STROOMVERZORGING
ALIMENTACION
STRØMFORSYNING
STRØMFORSYNING
ELFØRSØRNING
ЭЛЕКТРОПИТАНИЕ
电源



ART.	QC36 - QC37	QC38 - QC39	QC44 - QC45 QC52 - QC53	QC46 - QC47 QC54 - QC55
X (mm)	78	140	210	350

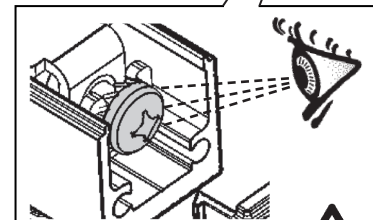
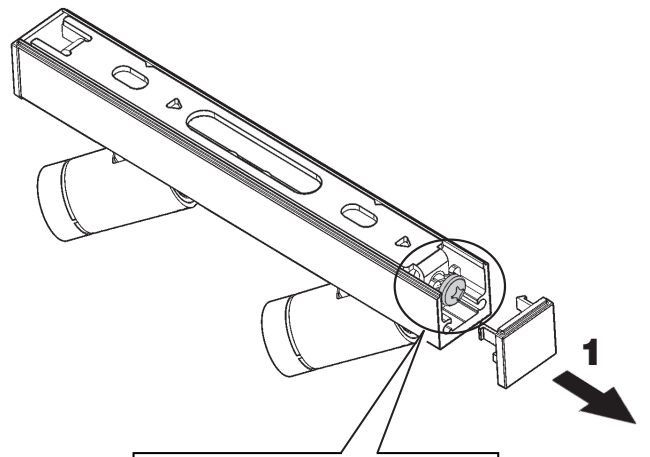

2 Allentare - Loosen
Desserrez - Lockern Sie
Draai los - Afloje
Løsne - Løsnes
Skruva loss - Ослабить
松开

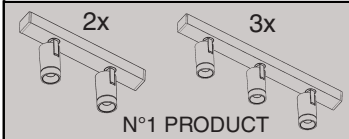
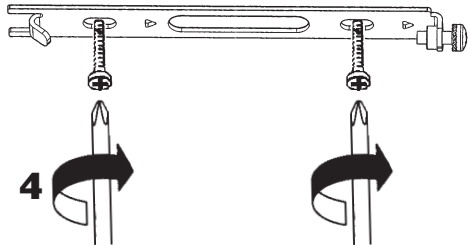
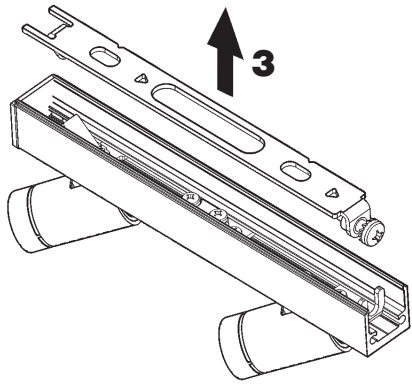

N°1 PRODUCT

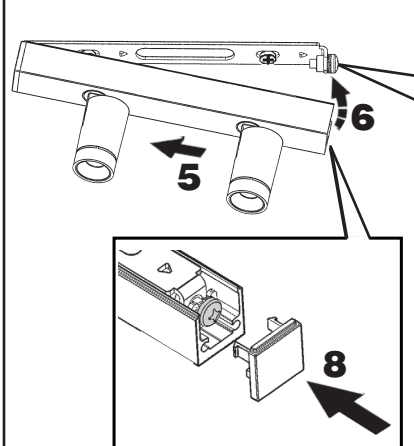
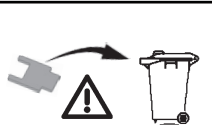

7 Avvitare fino in fondo
Completely tighten
Visser à fond
Fest anziehen
Helemaal aanschroeven
Enroscar hasta el fondo
Skrú i bund
Trekkt helt til
Skrúva fast till botten
Закрутить до упора
把螺丝钉完全拧紧

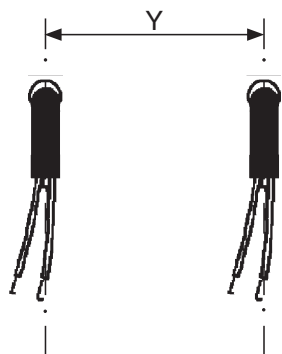
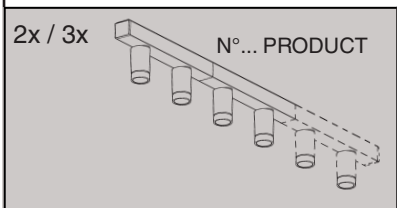
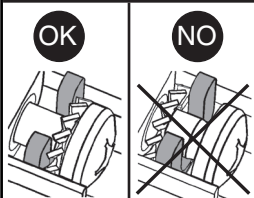

	Ø (mm)	(2x + 2x)	(3x + 3x)	(2x + 3x)
Y (mm)	19	144	216	180
	37	284	426	355
	51			

5 Avvitare fino in fondo
Completely tighten
Visser à fond
Fest anziehen
Helemaal aanschroeven
Enroscar hasta el fondo
Skrú i bund
Trekkt helt til
Skrúva fast till botten
Закрутить до упора
把螺丝钉完全拧紧

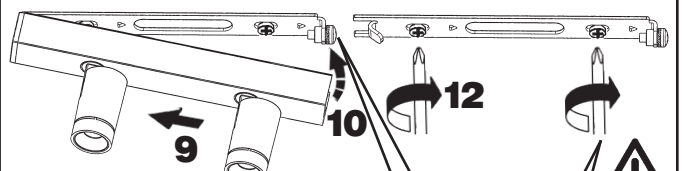
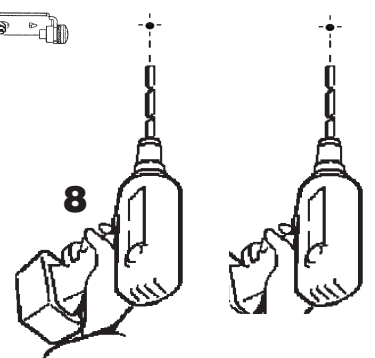
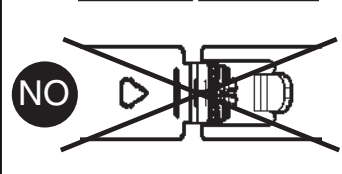
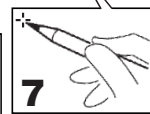
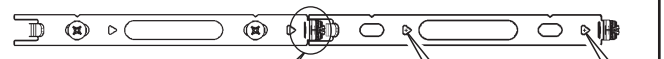
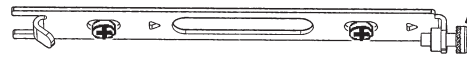

11 Avvitare fino in fondo
Completely tighten
Visser à fond
Fest anziehen
Helemaal aanschroeven
Enroscar hasta el fondo
Skrú i bund
Trekkt helt til
Skrúva fast till botten
Закрутить до упора
把螺丝钉完全拧紧

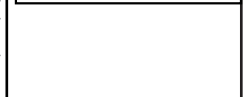
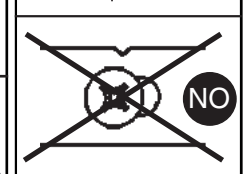
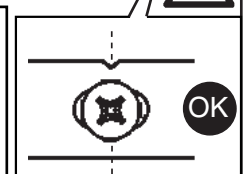
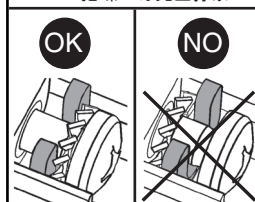

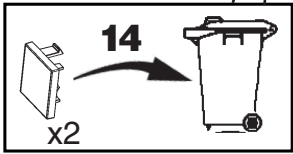
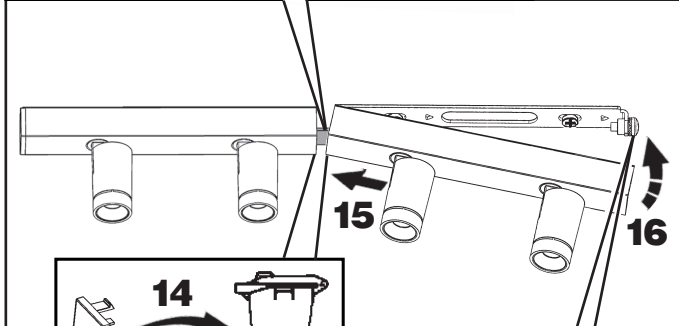
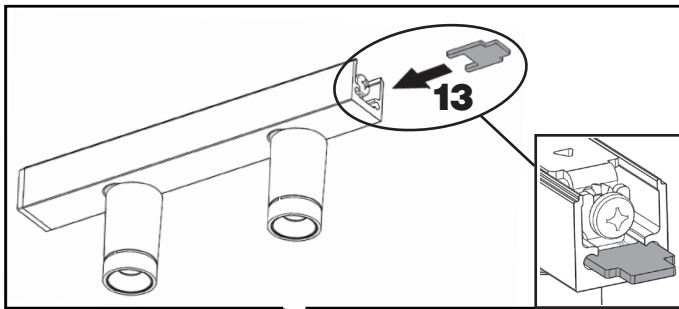

17 Avvitare fino in fondo
Completely tighten
Visser à fond
Fest anziehen
Helemaal aanschroeven
Enroscar hasta el fondo
Skrú i bund
Trek helt til
Skrúva fast till botten
Закрутить до упора
把螺丝钉完全拧紧

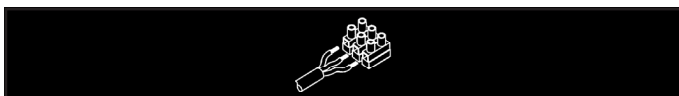
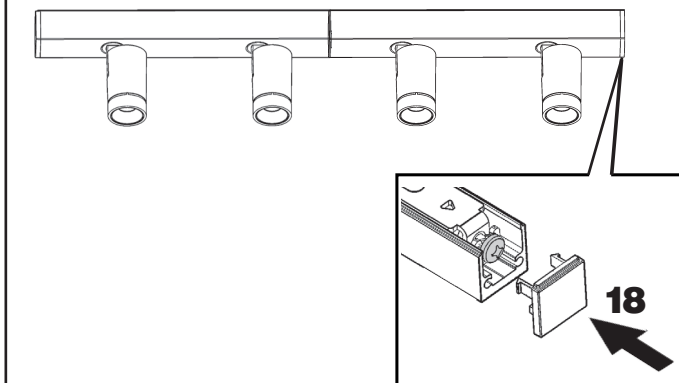
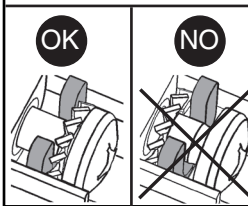

IT Le prestazioni e la sicurezza dell'apparecchio sono garantite soltanto per oscillazioni della corrente del $\pm 5\%$ rispetto al valore nominale.
La conformità alla norma è garantita soltanto utilizzando alimentatori iGuzzini (art.: BZM4 - X020 - MY83) od equivalenti di tipo SELV che rispondano alle vigenti norme C.E.I.

EN The performance level and safety of the lighting fixture are only guaranteed for oscillations of $\pm 5\%$ in the current, in relation to the nominal value.
Conformity with the standard is guaranteed only if either iGuzzini ballasts (item code BZM4 - X020 - MY83) or equivalent SELV type ballasts which comply with current C.E.I. regulations are used.

FR Les performances et la sécurité de l'appareil ne sont assurées que pour des oscillations de courant de $\pm 5\%$ par rapport à la valeur nominale.
La conformité à la norme n'est assurée qu'en cas d'utilisation de ballasts iGuzzini (réf. : BZM4 - X020 - MY83) ou équivalents type SELV conformes aux normes C.E.I.

DE Die Leistungen und die Sicherheit des Geräts sind nur für vom Vorschaltgerät abgehende Spannungsschwankungen von $\pm 5\%$ in Bezug auf den Nennwert gewährleistet.
Die Übereinstimmung mit den Vorschriften ist nur bei Verwendung von iGuzzini-Netzteilen (Art.: BZM4 - X020 - MY83) oder gleichwertigen des Typs SELV, die den gültigen CEI-Bestimmungen entsprechen, gewährleistet.

NL De prestaties en de veiligheid van het apparaat zijn alleen gegarandeerd voor spanningsvariëaties van $\pm 5\%$ ten opzichte van de nominale waarde.
De conformiteit aan de norm wordt alleen gegarandeerd als u iGuzzini voorschakelapparaten gebruikt (art.: BZM4 - X020 - MY83) of overeenkomstige, van het type SELV, die aan de geldende C.E.I. normen voldoen.

ES Las prestaciones y la seguridad del aparato están garantizada solamente con oscilaciones de la corriente del $\pm 5\%$ respecto al valor nominal.

La conformidad a la norma se garantiza solamente con el uso de alimentadores iGuzzini (art. BZM4 - X020 - MY83) o equivalentes de tipo SELV que cumplen las normas vigentes C.E.I.

DA Armaturets ydelse og sikkerhed kan kun garanteres ved strømudsving på $\pm 5\%$ i forhold til den nominelle værdi.

Opfyldelse af reglerne garanteres kun ved brug af strømforsyningsenheder fra iGuzzini (art.: BZM4 - X020 - MY83) eller tilsvarende af typen SELV, der opfylder kravene i C.E.I.-standarderne.

NO Ytelsesnivået og sikkerheten til lysarmaturen kan kun garanteres for svingninger på $\pm 5\%$ i strømmen, i forhold til nominell verdi.

Samsvar med forskriften garanteres bare ved bruk av transformatorer fra iGuzzini (art.: BZM4 - X020 - MY83) eller tilsvarende av typen SELV som tilsvare gjeldende forskrifter C.E.I.

SV Utrustningens prestanda och säkerhet garanteras endast vid en strömoscillation på $\pm 5\%$ i förhållande till nominellt värde.

Överensstämmelse med standard garanteras endast genom att använda nätaggregat av typ iGuzzini (art.: BZM4 - X020 - MY83) eller motsvarande av typ SELV som överensstämmer med gällande C.E.I.-standard.

RU Эксплуатационные качества и безопасность прибора гарантируются только при колебаниях тока $\pm 5\%$ от номинального значения.

Соответствие нормативу гарантируется только при использовании драйверов iGuzzini (арт.: BZM4 - X020 - MY83) или аналогичных типа SELV, отвечающих нормам ЭЭС.

ZH 只有在电流的额定值 $\pm 5\%$ 的情况下，才能保证装置的使用性能及安全性
只有在使用IGUZZINI的供电器 (BZM4 - X020 - MY83 产品) 或者与之相同的SELV种类的符合C.E.I.法规的供电器情况下，产品的合格性能才能保证

IT Cablare alla rete elettrica l'alimentatore solo dopo aver effettuato il collegamento ai prodotti

EN Wire the ballast to the power supply network only once it has been connected to the products

FR N'effectuer le câblage du ballast au réseau électrique qu'après avoir effectué le raccordement aux produits

DE Schließen Sie das Vorschaltgerät erst nach der Verdrahtung an den Produkten am Stromnetz an.

ES Cablear el alimentador a la red eléctrica sólo después de realizar la conexión de los productos.

NL Verbind het voorschakelapparaat alleen aan op het elektriciteitsnet nadat u alle producten heeft aangesloten.

DA Tilslut først strømforsyningsenheden til strømforsyningsnettet, efter at have foretaget tilslutningen til produkterne.

NO Kable transformatoren til el-nettet bare etter at produktene er tilkoblet

SV Anslut strömförsörjningsanordningen till elnätet först efter att anslutningen till produkterna har utförts.

RU Подсоединить к электросети блок питания только после подсоединения к приборам.

ZH 仅在镇流器连接到产品的时候才将其连接至电源网络

IT Morsettiera non inclusa. L'installazione può richiedere l'intervento di personale qualificato.

EN Terminal board not included. The aid of qualified personnel may be required for installation.

FR Bornier non inclus. L'installation pourrait exiger l'intervention de personnel qualifié.

DE Klemmenleiste nicht enthalten. Die Installation muss gegebenenfalls von Fachkräften durchgeführt werden.

NL Klemmenstrook niet inbegrepen. De installatie kan de hulp van gekwalificeerde installateurs vereisen.

ES Clema de conexiones no incluida. La instalación puede necesitar la intervención de personal calificado.

DA Klemkasse følger ikke med. Installation kan kræve hjælp fra en elektriker.

NO Klembrett ikke inkludert. Installasjonen kan kreve inngrep av kvalifisert personale.

SV Kopplingsplint ingår inte. Installationen kan kräva ingrepp från en utbildad fackman.

RU Безклемной колодки. Для монтажа может потребоваться вызвать квалифицированного электрика.

ZH 注意：不包括终端板。需要专业的技师进行安装。

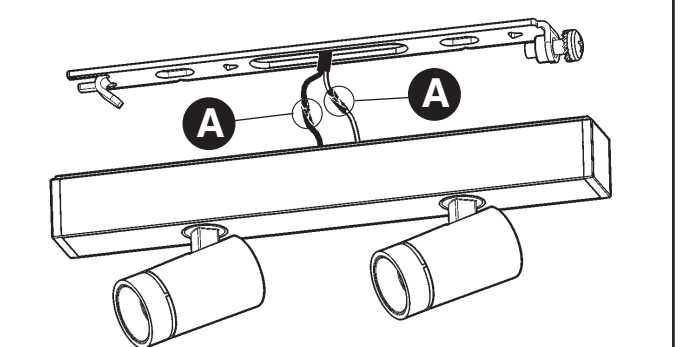

ROSSO
RED
ROUGE
ROT
ROOD
ROJO
RÖD
RÖD
RÖD
КРАСНЫЙ
红色

(+)

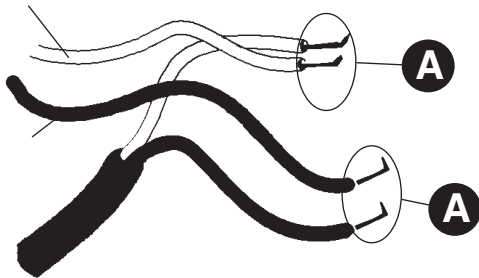

NERO
BLACK
NOIR
SCHWARZ
ZWART
NEGRO
SORT
SVART
ЧЕРНЫЙ
黑色

(-)

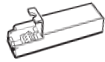
	S mm ²	Y mm	X mm	D mm
TCI - UNIVERSALE	0,2 - 1,5	8,5 - 9,5	30	3 - 8
TCI - DC MAXI JOLLY US	0,5 - 2,5	/	30	
TCI - DC MAXI JOLLY US DALI	0,5 - 2,5	/	30	

DALI VERSION
Art. BZM4

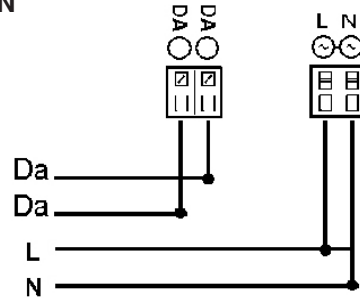

Art. QC34 - QC35 - QC36 - QC37 - QC38 - QC39

Art. X020

SEC

L N - +
■ ■ ■ ■

DIP SWITCH position	1	2	3	4
250mA	-	-	-	-
350mA	-	-	-	ON
400mA	-	-	ON	-
450mA	-	ON	-	-
500mA	-	-	ON	ON
550mA	-	ON	-	ON
650mA	-	ON	ON	-
700mA	-	ON	ON	ON
24V	ON	ON	ON	ON

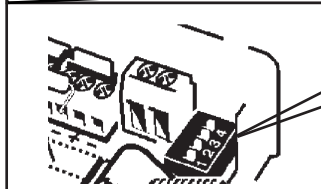

Art. QC34 - QC35 - QC36 - QC37 - QC38 - QC39

Art. MY83 - BZM4

PUSH L V AUX NTC 1...10V SEC

L N DaDa +- +- +- +-
■ ■ □ □ □ □ □ ■ ■

DIP SWITCH position	1	2	3	4	5	6
850mA	-	-	-	-	-	-
500mA	-	-	-	-	-	ON
550mA	-	-	-	-	ON	-
650mA	-	-	ON	-	-	ON
700mA	-	-	-	-	ON	ON
750mA	-	-	-	ON	ON	-
850mA	-	ON	-	-	-	ON
900mA	-	-	-	ON	ON	ON
1000mA	-	ON	ON	-	-	ON
1050mA	-	-	ON	ON	ON	ON



NASTRO AUTOAGGLOMERANTE
SELF-VULCANISING TAPE
RUBAN AUTO-SOUDABLE
SELBSTHAFTBAND - (Klebefilm SCOTCH 23 3M)
ZELFFUSERENDE TAPE
CINTA AUTOAGGLOMERANTE
(SCOTCH 23 3M)
SELVKLÆBENDE BÅND
SELVVULKANISERENDE TAPE
SJÄLVBINDANDE BAND
САМОПЛАСТИФИЦИРУЮЩАЯСЯ ЛЕНТА
自硫化带

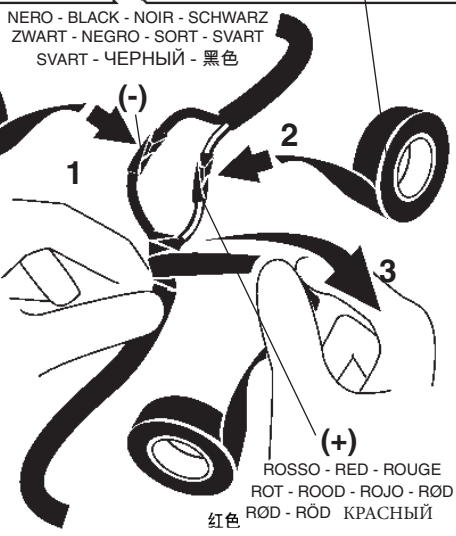

NERO - BLACK - NOIR - SCHWARZ
ZWART - NEGRO - SORT - SVART
SVART - ЧЕРНЫЙ - 黑色

ROSSO - RED - ROUGE
ROT - ROOD - ROJO - RÖD
RÖD - RÖD - КРАСНЫЙ
红色

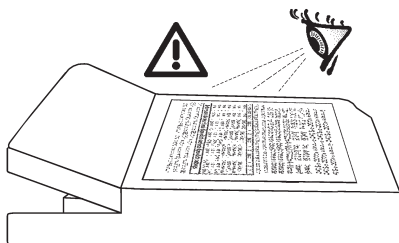
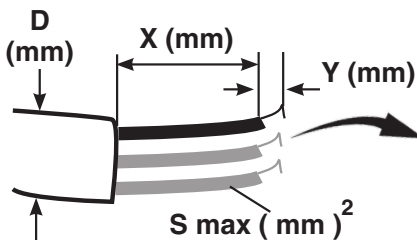

Art. QC40 - QC41 - QC42 - QC43 - QC44 - QC45 - QC46 - QC47

Art. MY83 - BZM4

PUSH L V AUX NTC 1...10V SEC
 L N DaDa +- +- +- +-
 ■ ■ □ □ □ □ □ □ ■ ■

DIP SWITCH position	1	2	3	4	5	6
350mA	-	-	-	-	-	-
500mA	-	-	-	-	-	ON
550mA	-	-	-	-	ON	-
650mA	-	-	ON	-	-	ON
700mA	-	-	-	-	ON	ON
750mA	-	-	-	ON	ON	-
850mA	-	ON	-	-	-	ON
900mA	-	-	-	ON	ON	ON
1000mA	-	ON	ON	-	-	ON
1050mA	-	-	ON	ON	ON	ON

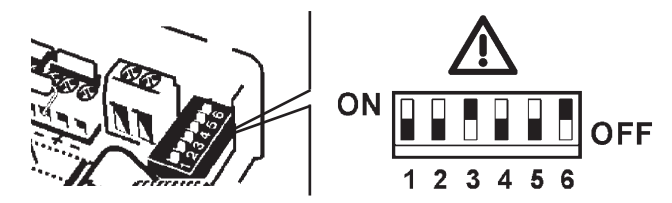

L MAX (m)
S (mm²)
L MAX: 100m

ART		
QC34 - QC35 QC36 - QC37 QC38 - QC39	QC40 - QC41 QC42 - QC43 QC44 - QC45 QC46 - QC47	QC48 - QC49 QC50 - QC51 QC52 - QC53 QC54 - QC55
L MAX	L MAX	L MAX
X020	110 x S	/
MY83 BZM4	110 x S	466 x S
		625 x S

IT In caso di danneggiamento del cavo flessibile esterno, questo deve essere sostituito dal costruttore, o dal suo servizio di assistenza, o da personale qualificato equivalente, al fine di evitare pericoli.

EN Should the outer flexible cable be somehow damaged, the latter should be replaced by the manufacturer, or by the corresponding service centre, or by an appropriate and qualified member of staff in order to avoid all risk of danger.

FR Si le câble flexible extérieur est abîmé, faites-le remplacer par le fabricant, par son service après-vente ou par un professionnel du secteur agréé afin d'éviter tout danger.

DE Sollte das äußere Kabel beschädigt sein, so muss es aus Sicherheitsgründen vom Hersteller, dessen Kundendienst oder von dazu autorisiertem Personal ausgewechselt werden.

NL Mocht de externe flexibele slang beschadigd worden, dan moet deze worden vervangen door de fabrikant of door een bevoegde installateur, zodat eventueel gevaar vermeden wordt.

ES En caso de daños el cable flexible externo debe substituirse por el fabricante, su servicio de asistencia o personal calificado equivalente para evitar peligros.

DA Hvis den yderste ledning beskadiges, skal den udskiftes af producenten eller et autoriseret teknisk servicecenter, eller af kvalificerede fagfolk, så man undgår farlige situationer.

NO Hvis ytre fleksible kabel skulle bli skadet, skal denne skiftes ut av produsenten eller tilsvarende servicesenter eller av en egnet og kvalifisert fagperson for å unngå farerisiko.

SV Om den yttre kabeln skadas ska den bytas ut av tillverkaren, av dess auktoriserade verkstad eller av likvärdig kvalificerad personal för att undvika alla typer av risker.

RU В случае повреждения внешнего гибкого кабеля во избежание риска поручите его замену производителю, уполномоченному сервису или квалифицированному электрику.

ZH 如果外部软缆损坏, 须由生产商、对应服务中心或能胜任和资深的员工更换新的电缆, 以避免任何可能的危险。

Art. QC48 - QC49 - QC50 - QC51 - QC52 - QC53 - QC54 - QC55

Art. MY83 - BZM4

PUSH L V AUX NTC 1...10V SEC
 L N DaDa +- +- +- +-
 ■ ■ □ □ □ □ □ □ ■ ■

DIP SWITCH position	1	2	3	4	5	6
350mA	-	-	-	-	-	-
500mA	-	-	-	-	-	ON
550mA	-	-	-	-	ON	-
650mA	-	-	ON	-	-	ON
700mA	-	-	-	-	ON	ON
750mA	-	-	-	ON	ON	-
850mA	-	ON	-	-	-	ON
900mA	-	-	-	ON	ON	ON
1000mA	-	ON	ON	-	-	ON
1050mA	-	-	ON	ON	ON	ON

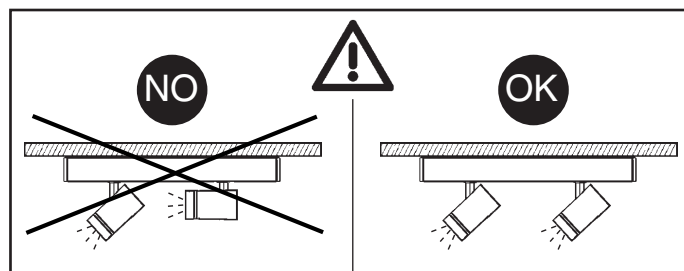
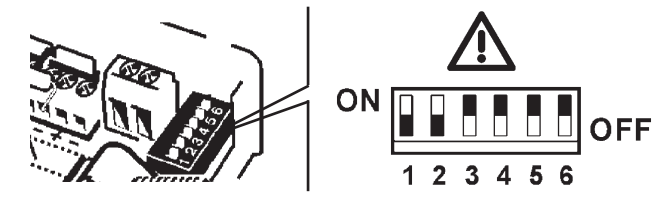

+ Art.

	MZ49	MZ52	MZ48	MZ51	MZ43	MZ45	MZ47	MZ50
19 mm	×	×	×	×	×	×	×	×
37 mm	✓	×	✓	×	✓	×	✓	×
51 mm	×	✓	×	✓	×	✓	×	✓

N° LED	ART		
	QC34 - QC35 QC36 - QC37 QC38 - QC39	QC40 - QC41 QC42 - QC43 QC44 - QC45 QC46 - QC47	QC48 - QC49 QC50 - QC51 QC52 - QC53 QC54 - QC55
X020	MAX 9	/	/
MY83	MAX 22	MAX 5	MAX 3
BZM4	MAX 22	MAX 5	MAX 4

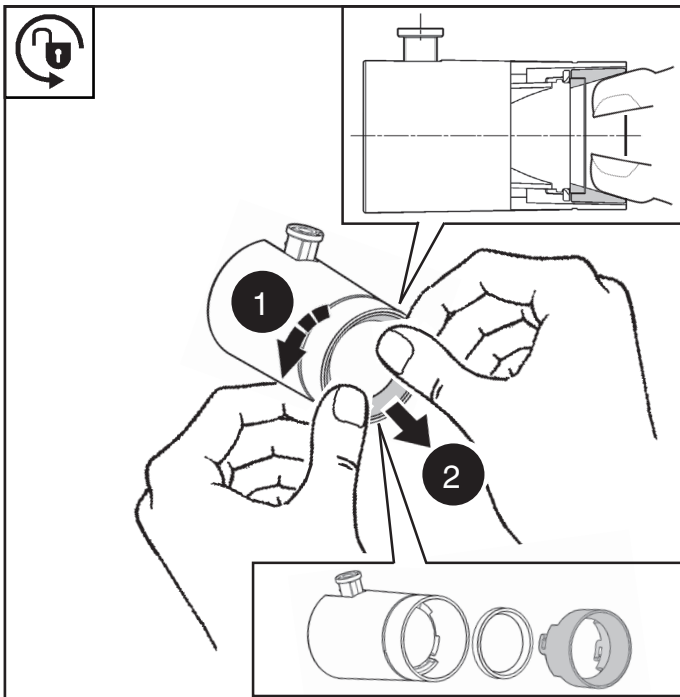

art.
MZ49
MZ52

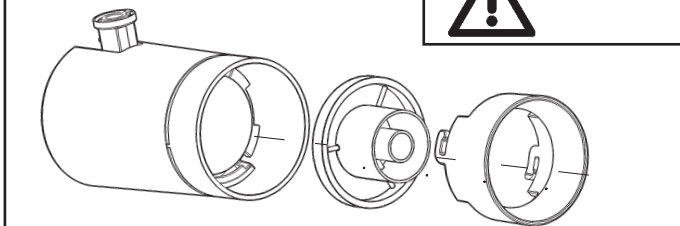
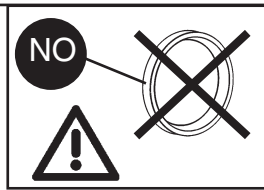

art.
MZ43
MZ45

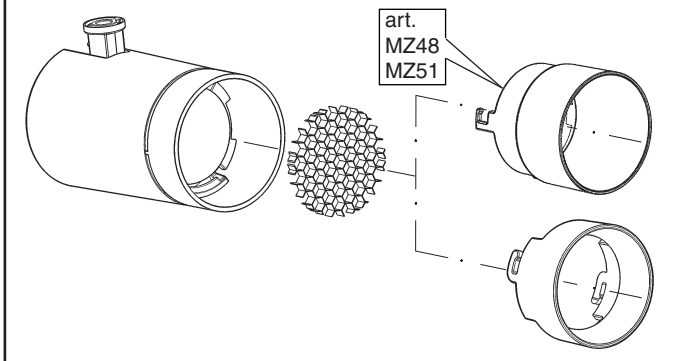
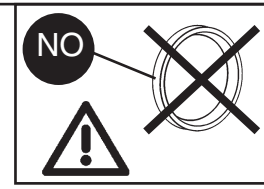

art.
MZ48
MZ51

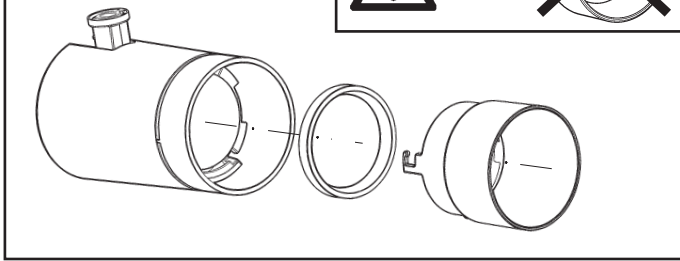
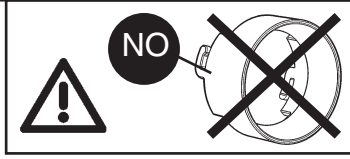

art.
MZ47
MZ50

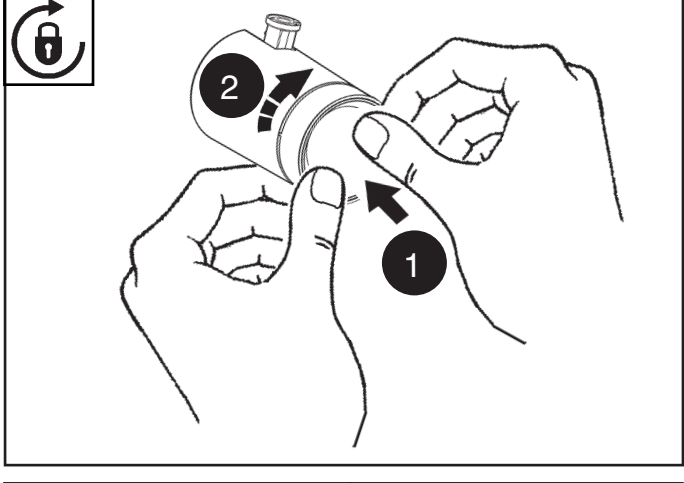
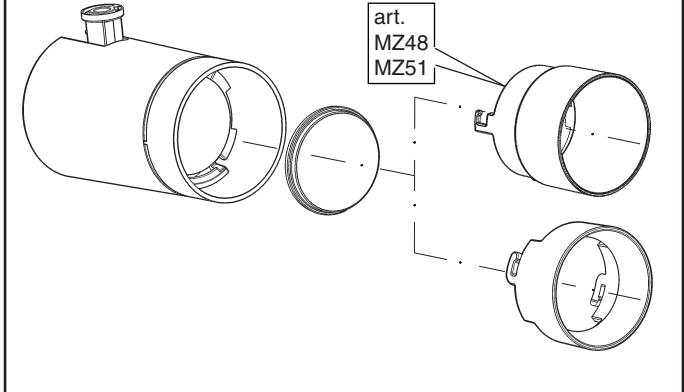
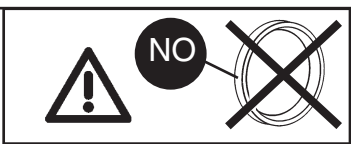

CARICO DALI / DALI LOAD
CHARGE DALI
(COURANT MAXI ADMISSIBLE)
DALI-LAST
DALI VERMOGEN
CARGA DALI
DALI STRØMSTYRKE
BELASTNING FOR "DALI"
DALI-BELASTNING
МАКС. ТОК СИСТЕМЫ DALI С
РЕГУЛЯЦИЕЙ ИНТЕНСИВНОСТИ СВЕТА
DALI 智能调光系统允许的最大电流量

INDIRIZZI DALI
DALI ADDRESSES
ADRESSES DALI
DALI-ADRESSEN
DALI ADRESSEN
DIRECCIONES DALI
DALI ADDRESSER
ADRESSER TIL "DALI"
DALI-ADRESSER
ЛОГИЧЕСКИЕ АДРЕСА СИСТЕМЫ DALI
DALI 智能调光系统计算机指定控制参数

1 (2 mA)

1

IT N.B.: Per la sostituzione del LED contattare l'azienda iGuzzini.
EN N.B.: For information on LED replacement please contact iGuzzini.
FR N.B.: Pour procéder au remplacement de la LED, adressez-vous à la société iGuzzini.
DE N.B.: Bezüglich des Austausches der LED kontaktieren Sie bitte die Firma iGuzzini.
NL N.B.: Voor het vervangen van de LED neemt u contact op met het bedrijf iGuzzini.
ES NOTA: Para sustituir el LED llame a la empresa iGuzzini.
DA N.B.: For udskiftning af lysdioden, skal man kontakte iGuzzini.
NO N.B.: For informasjon om skifte av LED, vennligst ta kontakt med iGuzzini.
SV OBS! För byte av lysdioden, kontakta företaget iGuzzini.
RU ПРИМЕЧАНИЕ: Для замены СИДов обращайтесь в компанию iGuzzini.
ZH 注意: 如需LED更换的信息, 请联系iGuzzini.

- I Istruzioni per le operazioni di servizio per l'apparecchio di illuminazione**
GB Instructions on luminaire service operations
F Instructions pour les opérations de service du luminaire
D Wartungsanleitung für die Leuchte
NL Instructies voor de onderhoudsoperaties op de verlichtingsarmatuur
E Instrucciones para las operaciones de servicio del aparato de alumbrado
DK Anvisninger i serviceindgreb på belysningsarmatur
N Anvisninger for betjening av lysapparatet
S Instruktioner för användning av belysningsanordningen
RUS Инструкция по эксплуатации осветительного прибора
CN 照明装置检修操作说明

Sostituire la lampada parzialmente esausta
 Replace the partly exhausted lamp
 Remplacer la lampe partiellement épuisée
 Die teilweise erschöpfte Lampe austauschen
 Vervang de gedeeltelijk lege lamp
 Sustituir la lámpara parzialmente agotada
 Udskift den delvist udtjente pære
 Skifte ut den delvis utbrente lyspæren
 Byt ut den delvis förbrukade lampan
 Замена частично отработанной лампочки
 更换部分老化的灯泡

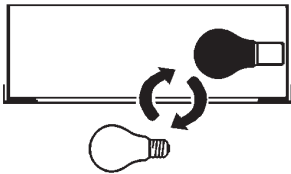

Spegnimento
 Switch it off
 Extinction
 Ausschaltung
 Uitschakeling
 Apagado
 Slukning
 Slukking
 Släckning
 Выключение
 关灯

Interrompere l'alimentazione dell'apparecchio
 Cut the power supply to the luminaire
 Couper l'alimentation du luminaire
 Stromversorgung der Leuchte unterbrechen
 Onderbreek de voeding van het apparaat
 Interrumpir la alimentación del aparato
 Afbryd armaturets strømforsyning
 Avbryte strømtilførselen til apparatet
 Koppla från anordningens strömförsörjning
 Отключить электропитание прибора
 中断装置供电

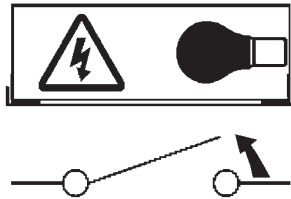

Aprire l'apparecchio
 Open the fixture
 Ouvrir le luminaire
 Das Gerät öffnen
 Open het apparaat
 Abrir el aparato
 Åbn armaturet
 Åpne apparatet
 Öppna anordningen
 Раскрыть прибор
 打开装置

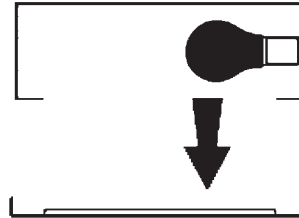

Rimuovere la lampada esausta
 Remove the exhausted lamp
 Retirer la lampe épuisée
 Die alte Lampe entnehmen
 Verwijder de lege lamp
 Quitar la lámpara agotada
 Tag den udtjente pære ud
 Fjerne den utbrente lyspæren
 Ta bort den förbrukade lampan
 Вынуть старую лампочку
 取出老化的灯泡

Portarla in un centro di riciclaggio
 Carry it to a recycling centre
 La porter dans une déchetterie pour son recyclage
 Ordnungsgemäß entsorgen
 Breng de lamp naar een recyclingcentrum
 Llevarla a un centro de reciclaje
 Aflever den på en genbrugsstation
 Lever den til en miljøstasjon
 Lämna in den till en återvinningsanläggning
 Сдать ее в пункт приема утильсырья
 将其送往回收中心

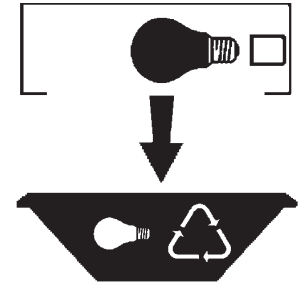

Inserire la nuova lampada
 Introduce the new lamp
 Installer la lampe neuve
 Die neue Lampe einsetzen
 Doe de nieuwe lamp op zijn plek
 Montar la nueva lámpara
 Sæt den nye pære i
 Sette i den nye pæren
 Sätt i den nya lampan
 Вставить новую лампочку
 装入新灯泡

Inserire la nuova lampada nel portalampada
 Fit the new lamp into the socket
 Installer la nouvelle lampe dans le support de lampe
 Die neue Lampe in den Sockel einsetzen
 Doe de nieuwe lamp in de lamphouder
 Montar la nueva lámpara en el portalámpara
 Sæt den nye pære i fatningen
 Sette den nye pæren inn i lampeholderen
 Sätt i den nya lampan i lamphållaren
 Вставить новую лампочку в патрон
 将新灯泡插入灯泡架中

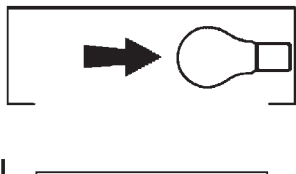

Riposizionare ottica
 Re-place the optic
 Remettre l'optique à sa place
 Die Optik wieder einsetzen
 Doe de optiek weer op zijn plaats
 Volver a montar la óptica
 Sæt den optiske enhed på plads
 Innstille linsen
 Flytta om optiken
 Отрегулировать линзы
 重新定位光头

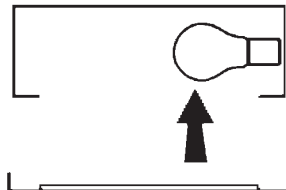

Effettuare prova di funzionamento
 Perform operative test
 Procéder à un essai de fonctionnement
 Eine Funktionsprüfung durchführen
 Controleer de correcte werking
 Hacer una prueba de funcionamiento
 Afprøv funktionen
 Prøve om den fungerer
 Utför funktionstest
 Выполнить проверку исправности работы
 执行功能测试

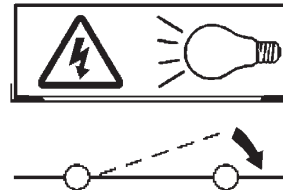

I Istruzioni per la pulizia dell'apparecchio di illuminazione
GB Instructions on luminaire cleaning operations
F Instructions pour le nettoyage du luminaire
D Anweisungen zur Reinigung der Leuchte
NL Instructies voor de reiniging van de verlichtingsarmatuur
E Instrucciones para limpiar el aparato de alumbrado
DK Anvisninger i rengøring af belysningsarmaturet
N Anvisninger for rengjøring av lysapparatet
S Instruktioner för rengöring av belysningsanordningen
RUS Инструкции по чистке осветительного прибора
CN 照明装置清洁说明

Pulire l'apparecchio
Clean the fixture
Nettoyer le luminaire
Das Gerät reinigen
Reinig het apparaat
Limpiar el aparato
Rengør armaturet
Rengjøre apparatet
Rengör anordningen
Чистка прибора
清洁装置

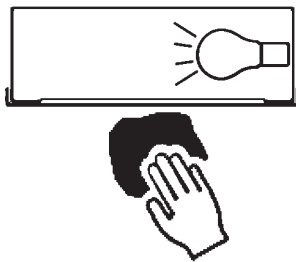

Spegnimento
Switch it off
Extinction
Ausschaltung
Uitschakeling
Apagado
Slukning
Slukking
Släckning
Выключение
关灯

Interrompere l'alimentazione dell'apparecchio
Cut the power supply to the luminaire
Couper l'alimentation du luminaire
Stromversorgung der Leuchte unterbrechen
Onderbreek de voeding van het apparaat
Interrumpir la alimentación del aparato
Afbryd armaturets strømforstyrning
Avbryt strømtilførselen til apparatet
Koppla från anordningens strömförsörjning
Отключить электропитание прибора
中断装置供电



Spolverare l'ottica esterna
Remove dust from the external optic
Dépoussiérer l'optique extérieure
Die externe Optik abstauben
Stof de externe optiek af
Quitar el polvo de la óptica exterior
Tør støvet af den udvendige optiske enhed
Fjerne støv fra den eksterne lysenheden
Damma av den yttre optiken
Вытереть пыль с внешней стороны линз
为外侧光头掸尘

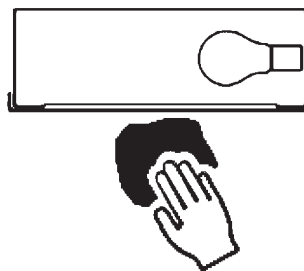

Lavare l'ottica esterna
Wash the external optic
Laver l'optique extérieure
Die externe Optik waschen
Was de externe optiek
Lavar la óptica exterior
Vask den udvendige optiske enhed
Vaske den eksterne lysenheden
Rengör den yttre optiken
Вымыть линзы с внешней стороны
清洁外光头

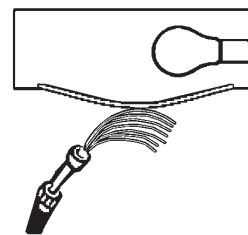

Rimuovere l'ottica
Remove the optic
Retirer l'optique
Die Optik abnehmen
Verwijder de optiek
Quitar la óptica
Tag den optiske enhed af
Fjerne lysenheden
Ta bort optiken
Снять линзы
取下光头

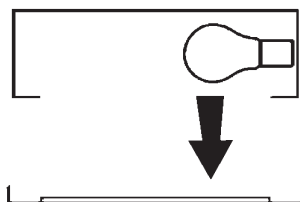

Pulire la parte interna dell'apparecchio di illuminazione
Clean the inside of the fixture
Nettoyer l'intérieur du luminaire
Die Innenseite der Leuchte reinigen
Reinig de binnenzijde van de verlichtingsarmatuur
Limpiar el interior del aparato de alumbrado
Rengør belysningsarmaturets indvendige dele
Rengjøre lysapparatet innvendig
Rengör belysningsanordningen invändigt
Протереть осветительный прибор изнутри
清洁照明装置内部



Riposizionare ottica
Re-place the optic
Remettre l'optique à sa place
Die Optik wieder einsetzen
Doe de optiek weer op zijn plaats
Volver a montar la óptica
Sæt den optiske enhed på plads
Innstille linsen
Flytta om optiken
Отрегулировать линзы
重新定位光头

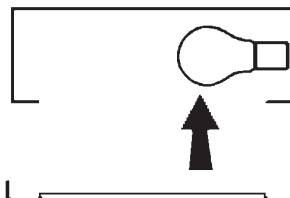

Effettuare prova di funzionamento
Perform operative test
Procéder à un essai de fonctionnement
Eine Funktionsprüfung durchführen
Controleer de correcte werking
Hacer una prueba de funcionamiento
Afprøv funktionen
Prøve om den fungerer
Utför funktionstest
Выполнить проверку исправности работы
执行功能测试

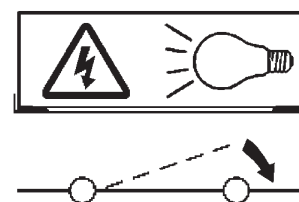

- I** Istruzioni per il fine vita e lo smaltimento dei componenti
GB Instructions on end-of-life and component disposal
F Instructions pour la gestion des composants en fin de vie et leur mise au rebut
D Anweisungen zur Entsorgung der Leuchtenkomponenten
NL Instructies voor het verwijderen van de armatuur en het recyclen van de onderdelen
E Instrucciones para el final de vida y la eliminación los componentes
DK Anvisninger i udtjent armatur og bortskaffelse af komponenter
N Anvisninger for endt levetid og avfallsbehandling av delene
S Instruktioner vid bortskaffning och kassering av komponenter
RUS Инструкции по утилизации прибора и его комплектующих по окончании его срока службы
CN 寿命期结束与零件废弃处置说明

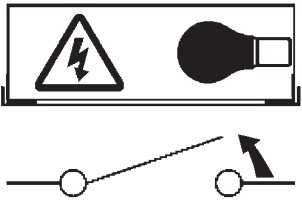
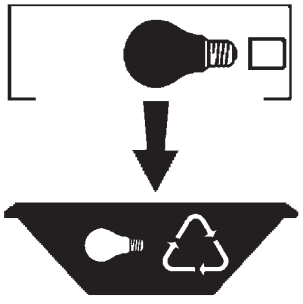
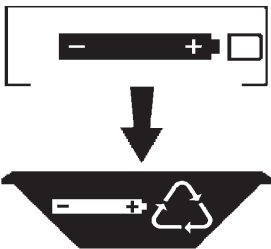
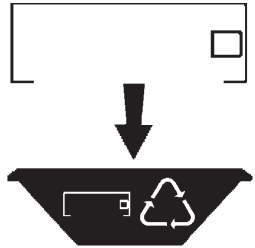
<p>Spegnimento Switch it off Extinction Ausschaltung Uitschakeling Apagado Slukning Slukking Släckning Выключение 关灯</p> <p>Interrompere l'alimentazione dell'apparecchio Cut the power supply to the luminaire Couper l'alimentation du luminaire Stromversorgung der Leuchte unterbrechen Onderbreek de voeding van het apparaat Interrompirla alimentación del aparato Afbryd armaturets strømforsyning Avbryt strømtilførselen til apparatet Koppla från anordningens strömförsörjning Отключить электропитание прибора 中断装置供电</p> 	<p>Rimuovere la/e lampada/e per la dismissione Remove the lamp(s) for decommissioning Retirer la(les) lampe(s) pour sa(leur) mise au rebut Die Lampe/n ordnungsgemäß entsorgen Verwijder de lamp(en) voor het recyclen Quitar la(s) lámpara(s) para el desecho Tag pæren/pærerne ud til bortskaffelse Fjerne lampen/-e som skal kastes Ta bort lampan/-orna för bortskaffningen Вынуть лампочку/и для утилизации прибора 取出需要丢弃的灯泡</p> 	<p>Rimuovere la batteria per la dismissione Remove the battery for decommissioning Retirer la batterie pour sa mise au rebut Die Batterie ordnungsgemäß entsorgen Verwijder de batterij voor het recyclen Quitar la batería para el desecho Tag batteriet ud til bortskaffelse Fjerne batteriet som skal kastes Ta bort batteriet för bortskaffningen Вынуть батарейку для утилизации прибора 取出需要丢弃的电池</p> 	<p>Rimuovere l'apparecchio per la dismissione Remove the fixture for decommissioning Enlever le luminaire pour sa mise au rebut Das Gerät ordnungsgemäß entsorgen Verwijder het apparaat voor het recyclen Quitar el aparato para el desecho Tag armaturet ud til bortskaffelse Fjerne apparatet som skal kastes Ta bort anordningen för bortskaffningen Снять прибор для утилизации 取出需要丢弃的装置</p> 
---	--	--	--

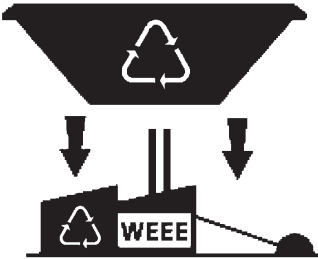
<p>Inviare i materiali ad un centro di raccolta RAEE Send the materials to a WEEE collection centre Envoyer les matériaux dans une déchetterie DEEE Die Materialien in einem WEEE-Zentrum entsorgen Zend de materialen naar een recyclingscentrum voor de AEEA Enviar los materiales a un centro de recogida RAEE Afløver materialerne på et indsamlingscenter for elektronisk udstyr Sende materialene til en miljøstasjon for resirkulering av EE-avfall Skicka materialet till en RAEE uppsamlingscentral Сдать материалы в пункт приема утильсырья 将材料送往电气和电子垃圾回收中心</p> 			
--	--	--	--