



ATTENZIONE:

LA SICUREZZA DELL'APPARECCHIO E' GARANTITA SOLO CON L'USO APPROPRIATO DELLE SEGUENTI ISTRUZIONI; PERTANTO E' NECESSARIO CONSERVARLE.

WARNING:

THE SAFETY OF THIS FIXTURE IS GUARANTEED ONLY IF YOU COMPLY WITH THESE INSTRUCTIONS; REMEMBER TO CONSERVE IN A SAFE PLACE.

ATTENTION:

LA SECURITE DE L'APPAREIL N'EST GARANTIE QU'EN CAS D'UTILISATION CORRECTE DES INSTRUCTIONS SUIVANTES; IL FAUT PAR CONSEQUENT LES CONSERVER.

ACHTUNG:

DIE SICHERHEIT DES GERÄTES WIRD NUR DURCH SACHGEMÄSSE BEFOLGUNG NACHSTEHENDER ANWEISUNGEN GEWÄHRLEISTET; IHRE AUFBEWAHRUNG IST DESHALB SEHR WICHTIG.

OPGELET:

DE VEILIGHEID VAN DI ATOESTEL IS SLECHTS DAN GEGARANDEERD ALS INDIEN DE VOLGENDE INSTRUCTIES STRIKT WORDEN TOEGEPAST: DAAROM MOET MEN ZE OOK BEWAREN.

ATENCION:

LA SEGURIDAD DEL APARATO SE GARANTIZA SOLO CUMPLIENDO CUIDADOSAMENTE LAS SIGUIENTES INSTRUCCIONES; POR ELLO, ES NECESARIO CONSERVARLAS.

BEMÆRK:

SIKKERHEDEN VED BRUG AF ARMATURET KAN KUN GARANTERES, HVIS DISSE ANVISNINGER FØLGES; SØRG DERFOR FOR AT GEMME DEM.

ADVARSEL:

SIKKERHETEN TIL DETTE APPARATET GARANTERES KUN HVIS DU OVERHOLDER DISSE INSTRUKSJONENE; HUSK Å OPPBEVARE DEM PÅ ET TRYGT STED.

OBSERVERA!

UTRUSTNINGENS SÄKERHET KAN ENDAST GARANTERAS OM DESSA ANVISNINGAR RESPEKTERAS I DETALJ. SPARA DÄRFÖR DESSA ANVISNINGAR FÖR FRAMTIDA KONSULTATION.

ВНИМАНИЕ:

МЫ ГАРАНТИРУЕМ БЕЗОПАСНУЮ ЭКСПЛУАТАЦИЮ ИЗДЕЛИЯ ТОЛЬКО ПРИ СОБЛЮДЕНИИ СЛЕДУЮЩИХ ИНСТРУКЦИЙ; С ЭТОЙ ЦЕЛЬЮ НЕОБХОДИМО СОХРАНИТЬ ДАННУЮ БРОШЮРУ.

警告

为确保该装置安全，请遵守操作指示；并于安全场所放置。

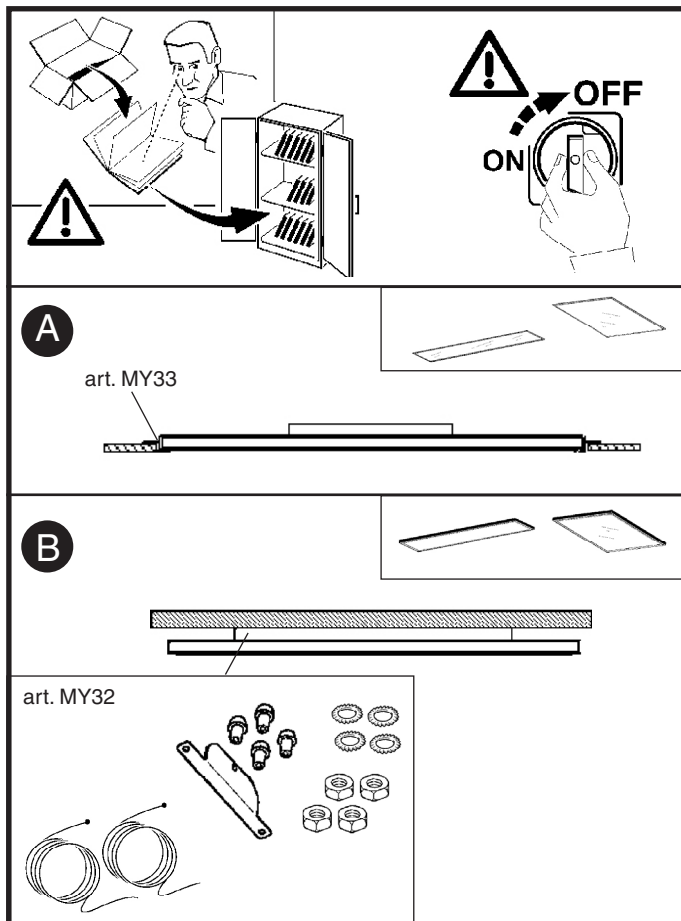
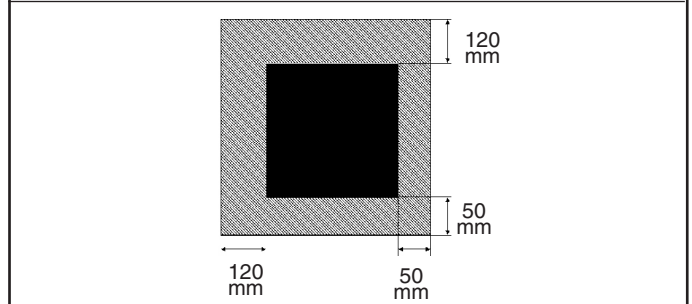
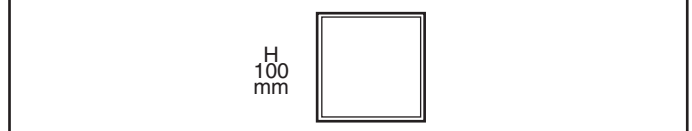
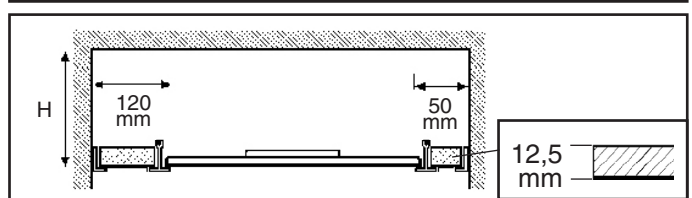
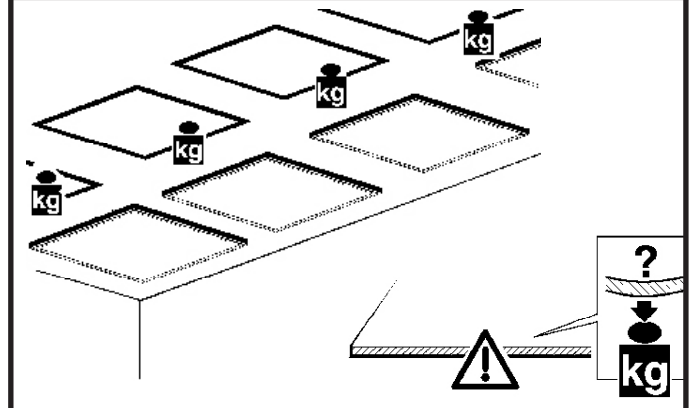
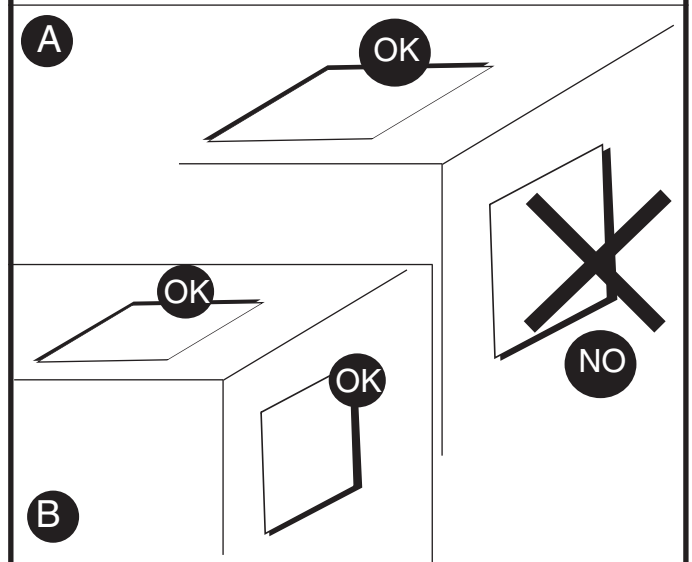
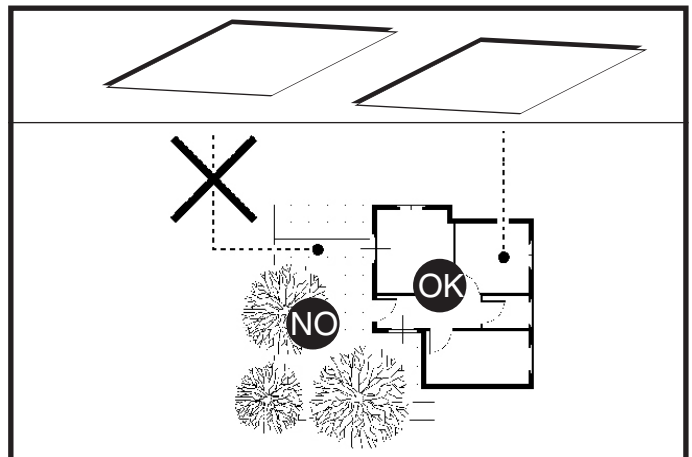

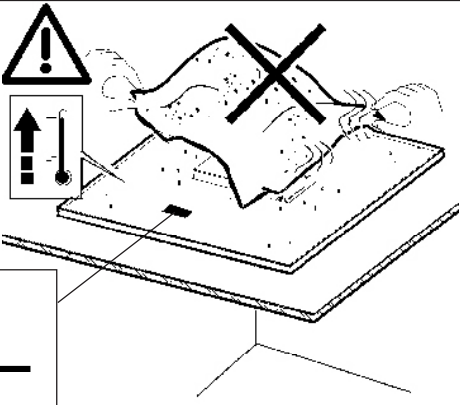

I N.B.: Apparecchi non idonei ad essere coperti di materiale termicamente isolante.
 GB N.B.: Fixtures not suitable to be covered in thermally-insulating material.
 F N.B.: Appareils ne pouvant pas être couverts de matériau d'isolation thermique.
 D N.B.: Geräte nicht geeignet, um mit wärmeisolierendem Material abgedeckt zu werden.
 NL N.B.: Deze apparaten zijn niet geschikt om te worden bedekt met thermisch isolerend materiaal.
 E NOTA: Aparatos no aptos para ser cubiertos de material térmicamente aislante.
 DK N.B.: Armaturerne må ikke dækkes af varmeisolerende materiale.
 N N.B.: Apparatene passer ikke til å dekkes av termoisolerende materialer.
 S OBS! Utrustningen får inte täckas över med värmeisolerande material.
 RUS Прибесы не пригодны для покрытия термизолирующим материалом.
 CN 灯具不适宜用隔热材料加以覆盖。

A

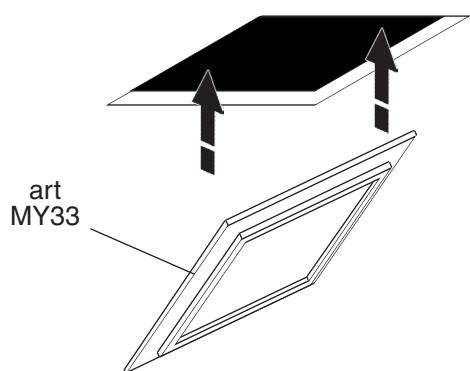
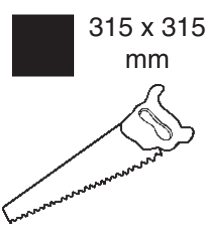
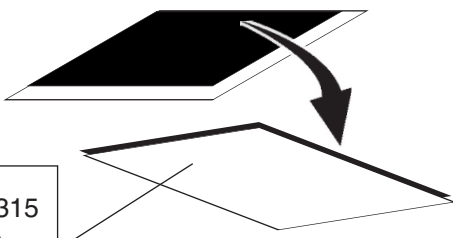

art MY33

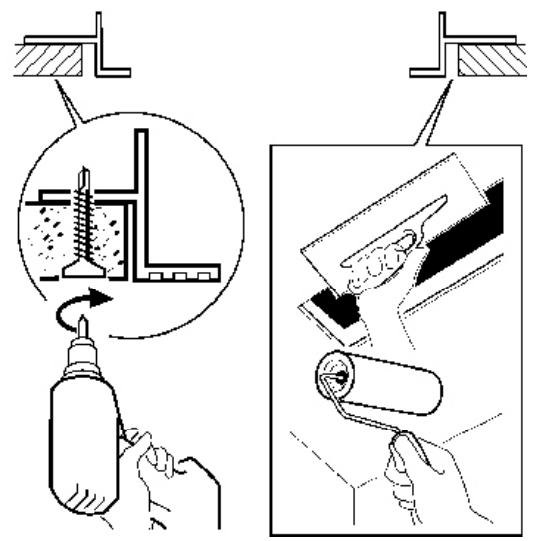
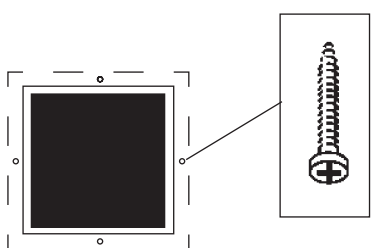

B

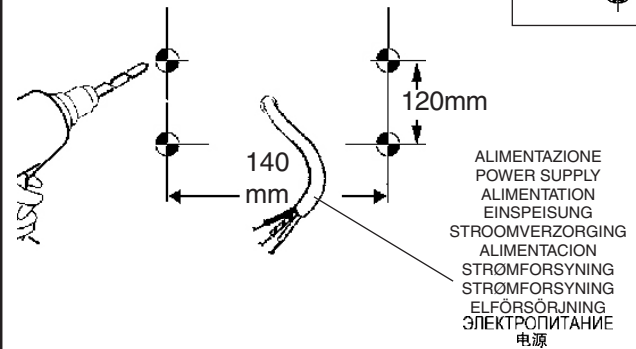
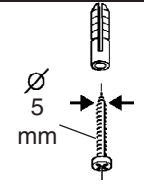

art MY32

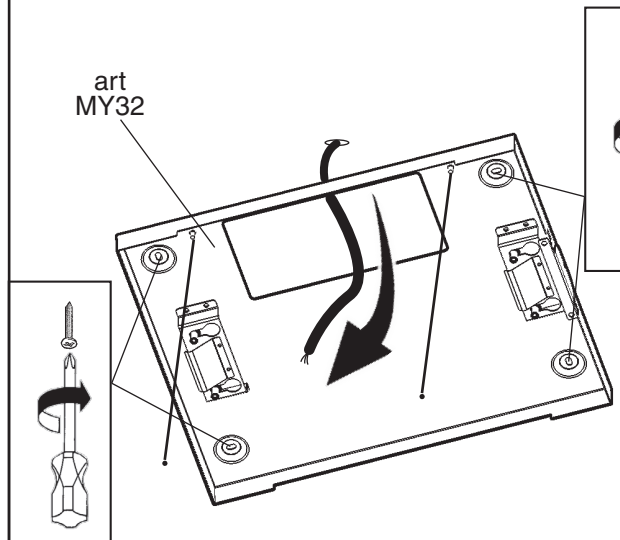

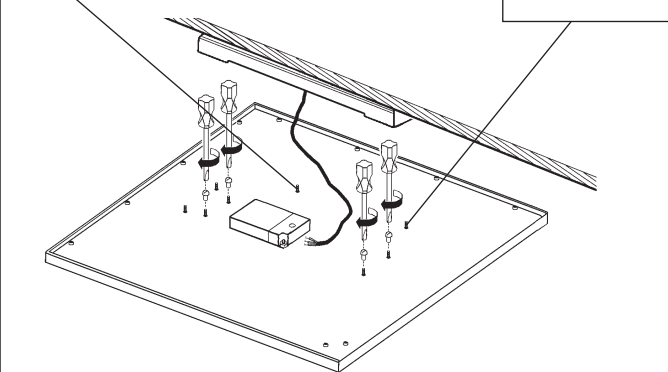
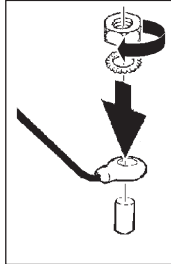
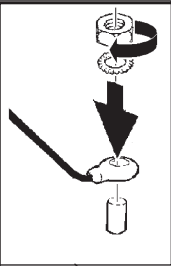
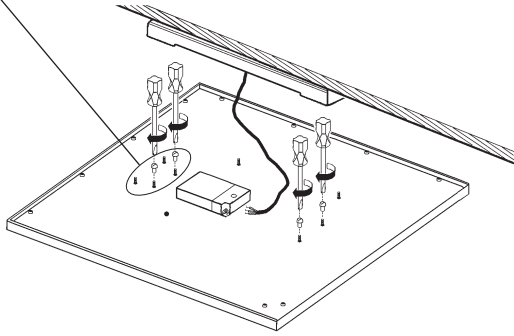
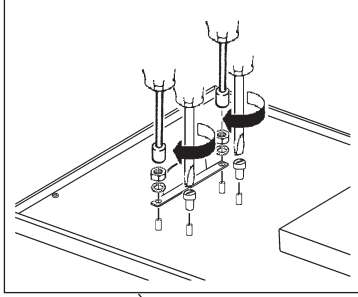

TCI

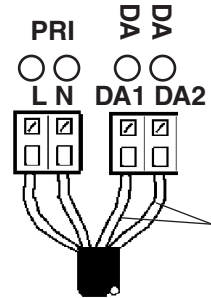
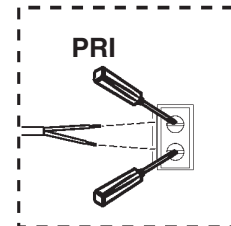
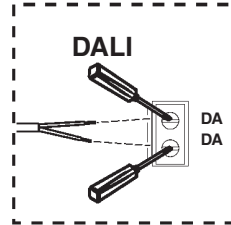
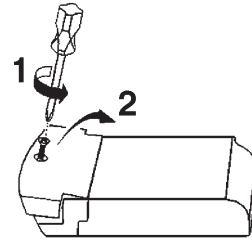
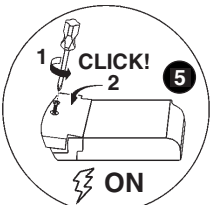
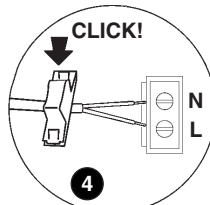
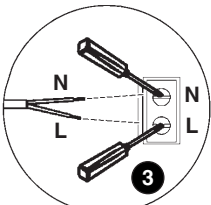
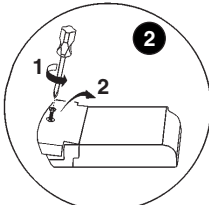
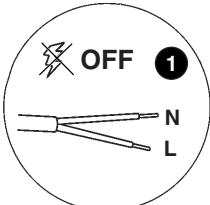

ALIMENTAZIONE
POWER SUPPLY
ALIMENTATION
EINSPEISUNG
STROMVERZORGUNG
ALIMENTACION
STRØMFORSYNING
STROMFORSYNING
ELFORSØRNING
ЭЛЕКТРОПИТАНИЕ
電源

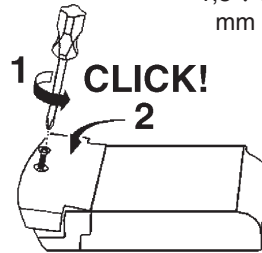
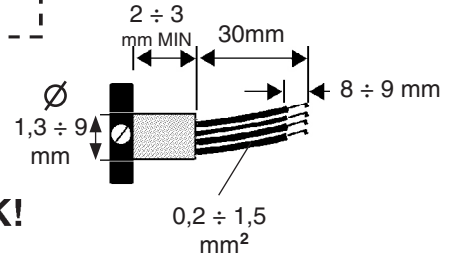

A

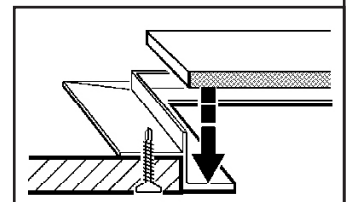
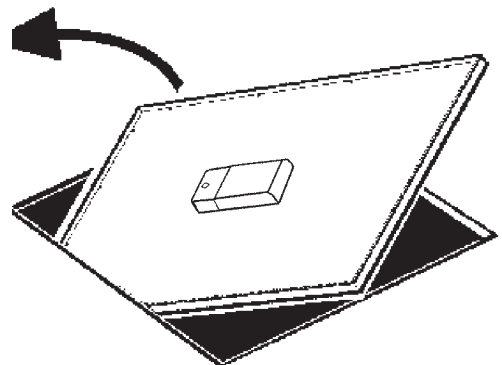

B

art. MY32

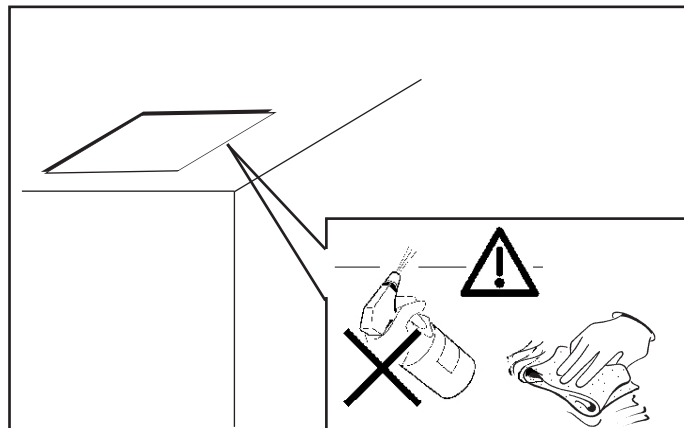
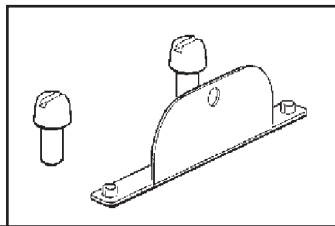
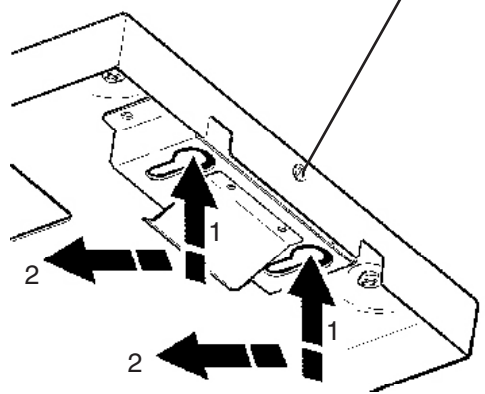
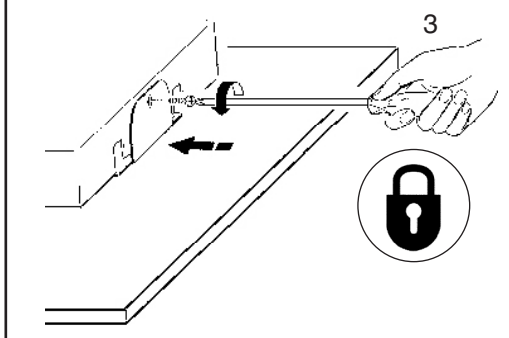

SOSTITUZIONE DEL LED
 REPLACING THE LED
 REMPLACEMENT DE LA LED
 AUSTAUSCHEN DER LED
 VERVANGEN VAN DE LED
 REEMPLAZO DEL LED
 UDSKIFTNING AF LYSDIODE
 BYTE AV LYSDIOD
 UTSKIFTING AV DEN LYSEMITTERENDE DIODEN
 ЗАМЕНА СИДла
 发光二极管替换

I N.B.: Per la sostituzione del LED contattare l'azienda iGuzzini.
 GB N.B.: For information on LED replacement please contact iGuzzini.
 F N.B.: Pour procéder au remplacement de la LED, adressez-vous à la société iGuzzini.
 D N.B.: Bezüglich des Austausches der LED kontaktieren Sie bitte die Firma iGuzzini.
 NL N.B.: Voor het vervangen van de LED neemt u contact op met het bedrijf iGuzzini.
 E NOTA: Para sustituir el LED llame a la empresa iGuzzini.
 DK N.B.: For udsiftning af lysdioden, skal man kontakte iGuzzini.
 N N.B.: For informasjon om skifte av LED, vennligst ta kontakt med iGuzzini.
 S OBS! För byte av lysdioden, kontakta företaget iGuzzini.
 RUS ПРИМЕЧАНИЕ: Для замены СИДов обращайтесь в компанию iGuzzini.
 CN 注意: 如需LED更换的信息, 请联系iGuzzini.

ART.	PESO WEIGHT POID GEWICHT GEWICHT PESO - VÆGT VEKT - VIKT BEC - 重量 (Kg)
P612 - P613 - P614 - P615	1,5

2.526.739.01
IS10220/01

iGuzzini

ART.	A	λ
MT10 - MT11 - MT14 - MT15	0,14	>0,9
MT18 - MT19 - MT22 - MT23	0,13	>0,9
MT12 - MT13 - MT16 - MT17	0,14	>0,95
MT20 - MT21 - MT24 - MT25 P178 - P179 - P180 - P223	0,12	>0,95
P612 - P613	0,08	>0,9
P614 - P615	0,07	>0,95

2.526.739.01
IS10220/01

iGuzzini

ART.	A	λ
MT10 - MT11 - MT14 - MT15	0,14	>0,9
MT18 - MT19 - MT22 - MT23	0,13	>0,9
MT12 - MT13 - MT16 - MT17	0,14	>0,95
MT20 - MT21 - MT24 - MT25 P178 - P179 - P180 - P223	0,12	>0,95
P612 - P613	0,08	>0,9
P614 - P615	0,07	>0,95

2.526.739.01
IS10220/01

iGuzzini

ART.	A	λ
MT10 - MT11 - MT14 - MT15	0,14	>0,9
MT18 - MT19 - MT22 - MT23	0,13	>0,9
MT12 - MT13 - MT16 - MT17	0,14	>0,95
MT20 - MT21 - MT24 - MT25 P178 - P179 - P180 - P223	0,12	>0,95
P612 - P613	0,08	>0,9
P614 - P615	0,07	>0,95

2.526.739.01
IS10220/01

iGuzzini

ART.	A	λ
MT10 - MT11 - MT14 - MT15	0,14	>0,9
MT18 - MT19 - MT22 - MT23	0,13	>0,9
MT12 - MT13 - MT16 - MT17	0,14	>0,95
MT20 - MT21 - MT24 - MT25 P178 - P179 - P180 - P223	0,12	>0,95
P612 - P613	0,08	>0,9
P614 - P615	0,07	>0,95

2.526.739.01
IS10220/01

iGuzzini

ART.	A	λ
MT10 - MT11 - MT14 - MT15	0,14	>0,9
MT18 - MT19 - MT22 - MT23	0,13	>0,9
MT12 - MT13 - MT16 - MT17	0,14	>0,95
MT20 - MT21 - MT24 - MT25 P178 - P179 - P180 - P223	0,12	>0,95
P612 - P613	0,08	>0,9
P614 - P615	0,07	>0,95

2.526.739.01
IS10220/01

iGuzzini

ART.	A	λ
MT10 - MT11 - MT14 - MT15	0,14	>0,9
MT18 - MT19 - MT22 - MT23	0,13	>0,9
MT12 - MT13 - MT16 - MT17	0,14	>0,95
MT20 - MT21 - MT24 - MT25 P178 - P179 - P180 - P223	0,12	>0,95
P612 - P613	0,08	>0,9
P614 - P615	0,07	>0,95

- I Istruzioni per le operazioni di servizio per l'apparecchio di illuminazione**
GB Instructions on luminaire service operations
F Instructions pour les opérations de service du luminaire
D Wartungsanleitung für die Leuchte
NL Instructies voor de onderhoudsoperaties op de verlichtingsarmatuur
E Instrucciones para las operaciones de servicio del aparato de alumbrado
DK Anvisninger i serviceindgreb på belysningsarmatur
N Anvisninger for betjening av lysapparatet
S Instruktioner för användning av belysningsanordningen
RUS Инструкции по эксплуатации осветительного прибора
CN 照明装置检修操作说明

Sostituire la lampada parzialmente esausta
 Replace the partly exhausted lamp
 Remplacer la lampe partiellement épuisée
 Die teilweise erschöpfte Lampe austauschen
 Vervang de gedeeltelijk lege lamp
 Sustituir la lámpara parzialmente agotada
 Udskift den delvist udtjente pære
 Skifte ut den delvis utbrente lyspæren
 Byt ut den delvis förbrukade lampan
 Замена частично отработавшей лампочки
 更换部分老化的灯泡

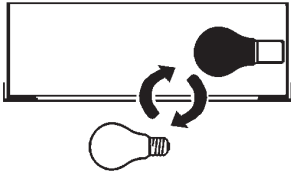

Spegnimento
 Switch it off
 Extinction
 Ausschaltung
 Uitschakeling
 Apagado
 Slukning
 Slukking
 Släckning
 Выключение
 关灯

Interrompere l'alimentazione dell'apparecchio
 Cut the power supply to the luminaire
 Couper l'alimentation du luminaire
 Stromversorgung der Leuchte unterbrechen
 Onderbreek de voeding van het apparaat
 Interrumpir la alimentación del aparato
 Afbryd armaturets strømforsyning
 Avbryte strømtilførselen til apparatet
 Koppla från anordningens strömförsörjning
 Отключить электропитание прибора
 中断装置供电

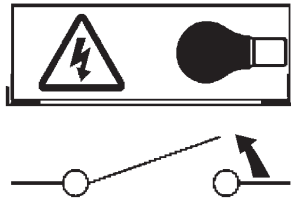

Aprire l'apparecchio
 Open the fixture
 Ouvrir le luminaire
 Das Gerät öffnen
 Open het apparaat
 Abrir el aparato
 Åbn armaturet
 Åpne apparatet
 Öppna anordningen
 Раскрыть прибор
 打开装置

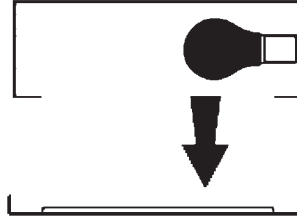

Rimuovere la lampada esausta
 Remove the exhausted lamp
 Retirer la lampe épuisée
 Die alte Lampe entnehmen
 Verwijder de lege lamp
 Quitar la lámpara agotada
 Tag den udtjente pære ud
 Fjerne den utbrente lyspæren
 Ta bort den förbrukade lampan
 Вынуть старую лампочку
 取出老化的灯泡

Portarla in un centro di riciclaggio
 Carry it to a recycling centre
 La porter dans une déchetterie pour son recyclage
 Ordnungsgemäß entsorgen
 Breng de lamp naar een recyclingcentrum
 Llevarla a un centro de reciclaje
 Aflever den på en genbrugsstation
 Lever den til en miljøstasjon
 Lämna in den till en återvinningsanläggning
 Сдать ее в пункт приема утильсырья
 将其送往回收中心

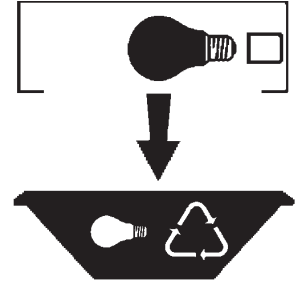

Inserire la nuova lampada
 Introduce the new lamp
 Installer la lampe neuve
 Die neue Lampe einsetzen
 Doe de nieuwe lamp op zijn plek
 Montar la nueva lámpara
 Sæt den nye pære i
 Sette i den nye pæren
 Sätt i den nya lampan
 Вставить новую лампочку
 装入新灯泡

Inserire la nuova lampada nel portalampada
 Fit the new lamp into the socket
 Installer la nouvelle lampe dans le support de lampe
 Die neue Lampe in den Sockel einsetzen
 Doe de nieuwe lamp in de lamphouder
 Montar la nueva lámpara en el portalámpara
 Sæt den nye pære i fatningen
 Sette den nye pæren inn i lampeholderen
 Sätt i den nya lampan i lamphållaren
 Вставить новую лампочку в патрон
 将新灯泡插入灯泡架中

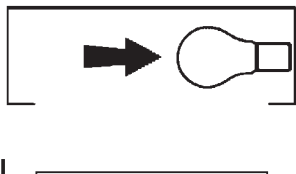

Riposizionare ottica
 Re-place the optic
 Remettre l'optique à sa place
 Die Optik wieder einsetzen
 Doe de optiek weer op zijn plaats
 Volver a montar la óptica
 Sæt den optiske enhed på plads
 Innstille linsen
 Flytta om optiken
 Отрегулировать линзы
 重新定位光头

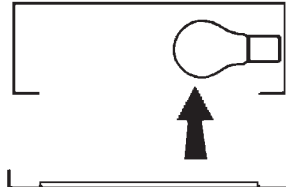

Effettuare prova di funzionamento
 Perform operative test
 Procéder à un essai de fonctionnement
 Eine Funktionsprüfung durchführen
 Controleer de correcte werking
 Hacer una prueba de funcionamiento
 Afprøv funktionen
 Prøve om den fungerer
 Utför funktionstest
 Выполнить проверку исправности работы
 执行功能测试

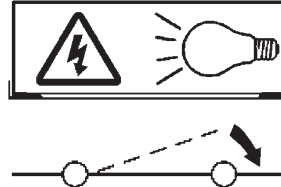

I Istruzioni per la pulizia dell'apparecchio di illuminazione
GB Instructions on luminaire cleaning operations
F Instructions pour le nettoyage du luminaire
D Anweisungen zur Reinigung der Leuchte
NL Instructies voor de reiniging van de verlichtingsarmatuur
E Instrucciones para limpiar el aparato de alumbrado
DK Anvisninger i rengøring af belysningsarmaturet
N Anvisninger for rengjøring av lysapparatet
S Instruktioner för rengöring av belysningsanordningen
RUS Инструкции по чистке осветительного прибора
CN 照明装置清洁说明

Pulire l'apparecchio
 Clean the fixture
Nettoyer le luminaire
 Das Gerät reinigen
Reinig het apparaat
 Limpiar el aparato
Rengør armaturet
Rengjøre apparatet
Rengör anordningen
 Чистка прибора
 清洁装置

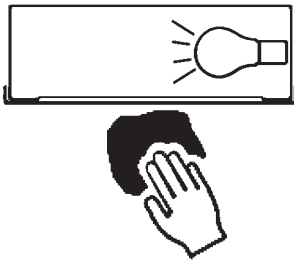

Spegnimento
 Switch it off
Extinction
Ausschaltung
Uitschakeling
Apagado
Slukning
Slukking
Släckning
Выключение
 关灯

Interrompere l'alimentazione dell'apparecchio
 Cut the power supply to the luminaire
 Couper l'alimentation du luminaire
 Stromversorgung der Leuchte unterbrechen
 Onderbreek de voeding van het apparaat
 Interrumpir la alimentación del aparato
 Afbryd armaturets strømforstyrning
 Avbryt strømtilførselen til apparatet
 Koppla från anordningens strömförsörjning
 Отключить электропитание прибора
 中断装置供电



Spolverare l'ottica esterna
 Remove dust from the external optic
Dépoussiérer l'optique extérieure
Die externe Optik abstauben
Stof de externe optiek af
Quitar el polvo de la óptica exterior
Tør støvet af den udvendige optiske enhed
Fjerne støv fra den eksterne lysenheten
Damma av den yttre optiken
Вытереть пыль с внешней стороны линз
 为外侧光头掸尘

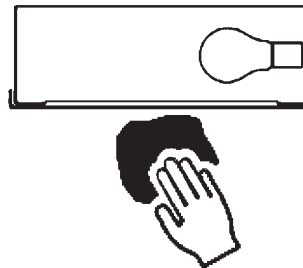

Lavare l'ottica esterna
 Wash the external optic
Laver l'optique extérieure
Die externe Optik waschen
Was de externe optiek
Lavar la óptica exterior
Vask den udvendige optiske enhed
Vaske den eksterne lysenheten
Rengör den yttre optiken
Вымыть линзы с внешней стороны
 清洁外光头

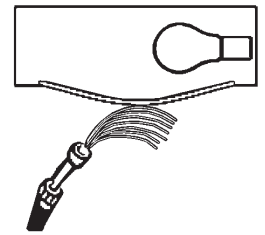

Rimuovere l'ottica
 Remove the optic
Retirer l'optique
Die Optik abnehmen
Verwijder de optiek
Quitar la óptica
Tag den optiske enhed af
Fjerne lysenheten
Ta bort optiken
Снять линзы
 取下光头

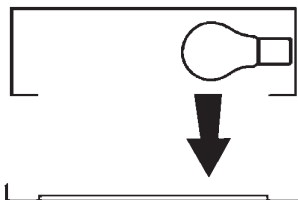

Pulire la parte interna dell'apparecchio di illuminazione
 Clean the inside of the fixture
Nettoyer l'intérieur du luminaire
Die Innenseite der Leuchte reinigen
Reinig de binnenzijde van de verlichtingsarmatuur
Limpiar el interior del aparato de alumbrado
Rengør belysningsarmaturets indvendige dele
Rengjøre lysapparatet innvendig
Rengör belysningsanordningen invändigt
Протереть осветительный прибор изнутри
 清洁照明装置内部



Riposizionare ottica
 Re-place the optic
Remettre l'optique à sa place
Die Optik wieder einsetzen
Doe de optiek weer op zijn plaats
Volver a montar la óptica
Sæt den optiske enhed på plads
Innstille linsen
Flytta om optiken
Отрегулировать линзы
 重新定位光头

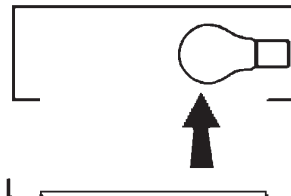

Effettuare prova di funzionamento
 Perform operative test
Procéder à un essai de fonctionnement
Eine Funktionsprüfung durchführen
Controleer de correcte werking
Hacer una prueba de funcionamiento
Afprøv funktionen
Prøve om den fungerer
Utför funktionstest
Выполнить проверку исправности работы
 执行功能测试

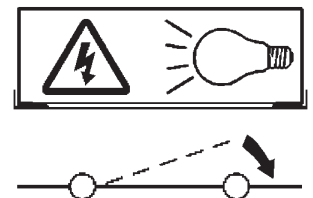

- I** Istruzioni per il fine vita e lo smaltimento dei componenti
GB Instructions on end-of-life and component disposal
F Instructions pour la gestion des composants en fin de vie et leur mise au rebut
D Anweisungen zur Entsorgung der Leuchtenkomponenten
NL Instructies voor het verwijderen van de armatuur en het recyclen van de onderdelen
E Instrucciones para el final de vida y la eliminación los componentes
DK Anvisninger i udtjent armatur og bortskaffelse af komponenter
N Anvisninger for endt levetid og avfallsbehandling av delene
S Instruktioner vid bortskaffning och kassering av komponenter
RUS Инструкции по утилизации прибора и его комплектующих по окончании его срока службы
CN 寿命期结束与零件废弃处置说明

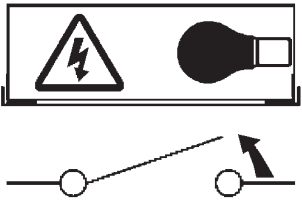
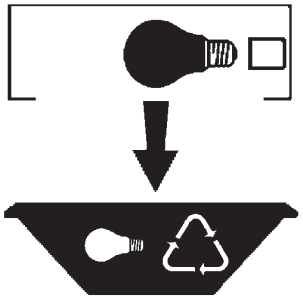
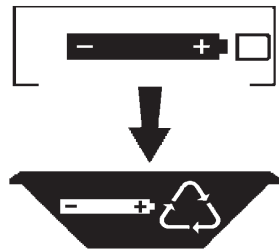
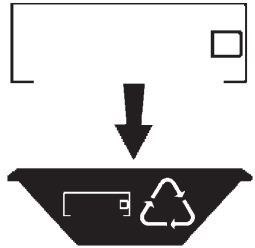
<p>Spegnimento Switch it off Extinction Ausschaltung Uitschakeling Apagado Slukning Slukking Släckning Выключение 关灯</p> <p>Interrompere l'alimentazione dell'apparecchio Cut the power supply to the luminaire Couper l'alimentation du luminaire Stromversorgung der Leuchte unterbrechen Onderbreek de voeding van het apparaat Interrompirla alimentación del aparato Afbryd armaturets strømforsyning Avbryt strømtilførselen til apparatet Koppla från anordningens strömförsörjning Отключить электропитание прибора 中断装置供电</p> 	<p>Rimuovere la/e lampada/e per la dismissione Remove the lamp(s) for decommissioning Retirer la(les) lampe(s) pour sa(leur) mise au rebut Die Lampe/n ordnungsgemäß entsorgen Verwijder de lamp(en) voor het recyclen Quitar la(s) lámpara(s) para el desecho Tag pæren/pærerne ud til bortskaffelse Fjerne lampen/-e som skal kastes Ta bort lampan/-orna för bortskaffningen Вынуть лампочку/и для утилизации прибора 取出需要丢弃的灯泡</p> 	<p>Rimuovere la batteria per la dismissione Remove the battery for decommissioning Retirer la batterie pour sa mise au rebut Die Batterie ordnungsgemäß entsorgen Verwijder de batterij voor het recyclen Quitar la batería para el desecho Tag batteriet ud til bortskaffelse Fjerne batteriet som skal kastes Ta bort batteriet för bortskaffningen Вынуть батарейку для утилизации прибора 取出需要丢弃的电池</p> 	<p>Rimuovere l'apparecchio per la dismissione Remove the fixture for decommissioning Enlever le luminaire pour sa mise au rebut Das Gerät ordnungsgemäß entsorgen Verwijder het apparaat voor het recyclen Quitar el aparato para el desecho Tag armaturet ud til bortskaffelse Fjerne apparatet som skal kastes Ta bort anordningen för bortskaffningen Снять прибор для утилизации 取出需要丢弃的装置</p> 
---	--	--	--

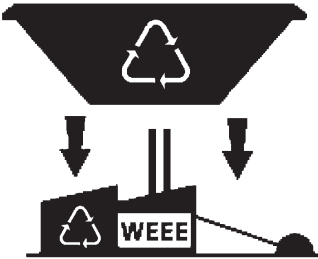
<p>Inviare i materiali ad un centro di raccolta RAEE Send the materials to a WEEE collection centre Envoyer les matériaux dans une déchetterie DEEE Die Materialien in einem WEEE-Zentrum entsorgen Zend de materialen naar een recyclingscentrum voor de AEEA Enviar los materiales a un centro de recogida RAEE Afløver materialerne på et indsamlingscenter for elektronisk udstyr Sende materialene til en miljøstasjon for resirkulering av EE-avfall Skicka materialet till en RAEE uppsamlingscentral Сдать материалы в пункт приема утильсырья 将材料送往电气和电子垃圾回收中心</p> 			
--	--	--	--