



**ATTENZIONE:**

LA SICUREZZA DELL'APPARECCHIO E' GARANTITA SOLO CON L'USO APPROPRIATO DELLE SEGUENTI ISTRUZIONI; PERTANTO E' NECESSARIO CONSERVARLE.

**WARNING:**

THE SAFETY OF THIS FIXTURE IS GUARANTEED ONLY IF YOU COMPLY WITH THESE INSTRUCTIONS; REMEMBER TO CONSERVE IN A SAFE PLACE.

**ATTENTION:**

LA SECURITE DE L'APPAREIL N'EST GARANTIE QU'EN CAS D'UTILISATION CORRECTE DES INSTRUCTIONS SUIVANTES; IL FAUT PAR CONSEQUENT LES CONSERVER.

**ACHTUNG:**

DIE SICHERHEIT DES GERÄTES WIRD NUR DURCH SACHGEMÄSSE BEFOLGUNG NACHSTEHENDER ANWEISUNGEN GEWÄHRLEISTET; IHRE AUFBEWAHRUNG IST DESHALB SEHR WICHTIG.

**OPGELET:**

DE VEILIGHEID VAN DI ATOESTEL IS SLECHTS DAN GEGARANDEERD ALS INDIEN DE VOLGENDE INSTRUCTIES STRIKT WORDEN TOEGEPAST: DAAROM MOET MEN ZE OOK BEWAREN.

**ATENCION:**

LA SEGURIDAD DEL APARATO SE GARANTIZA SOLO CUMPLIENDO CUIDADOSAMENTE LAS SIGUIENTES INSTRUCCIONES; POR ELLO, ES NECESARIO CONSERVARLAS.

**BEMÆRK:**

SIKKERHEDEN VED BRUG AF ARMATURET KAN KUN GARANTERES, HVIS DISSE ANVISNINGER FØLGES; SØRG DERFOR FOR AT GEMME DEM.

**ADVARSEL:**

SIKKERHETEN TIL DETTE APPARATET GARANTERES KUN HVIS DU OVERHOLDER DISSE INSTRUKSJONENE; HUSK Å OPPBEVARE DEM PÅ ET TRYGT STED.

**OBSERVERA!**

UTRUSTNINGENS SÄKERHET KAN ENDAST GARANTERAS OM DESSA ANVISNINGAR RESPEKTERAS I DETALJ. SPARA DÄRFÖR DESSA ANVISNINGAR FÖR FRAMTIDA KONSULTATION.

**ВНИМАНИЕ:**

МЫ ГАРАНТИРУЕМ БЕЗОПАСНУЮ ЭКСПЛУАТАЦИЮ ИЗДЕЛИЯ ТОЛЬКО ПРИ СОБЛЮДЕНИИ СЛЕДУЮЩИХ ИНСТРУКЦИЙ; С ЭТОЙ ЦЕЛЬЮ НЕОБХОДИМО СОХРАНИТЬ ДАННУЮ БРОШЮРУ.

**警告**

为确保该装置安全，请遵守操作指示；并于安全场所放置。

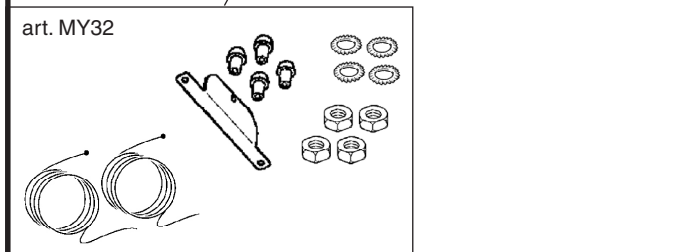
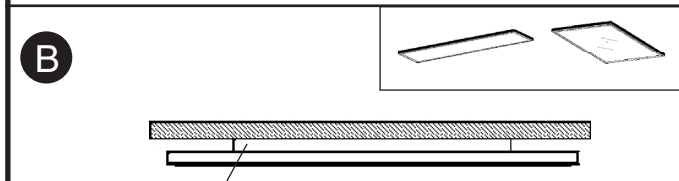
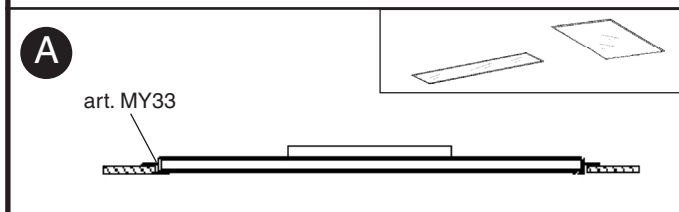
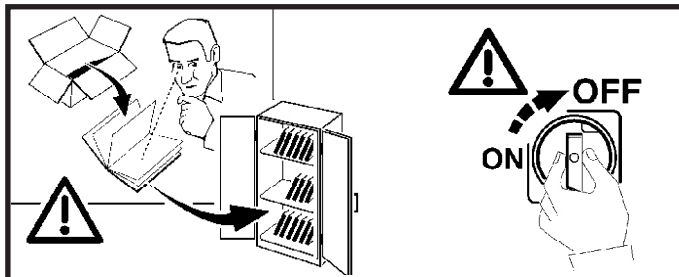
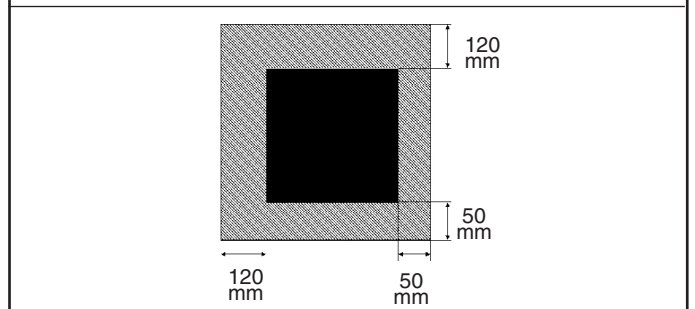
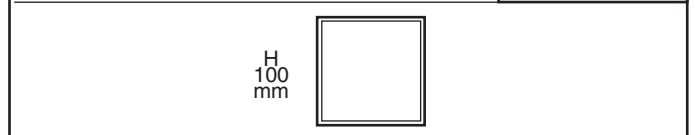
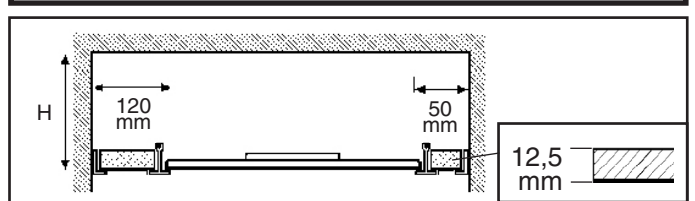
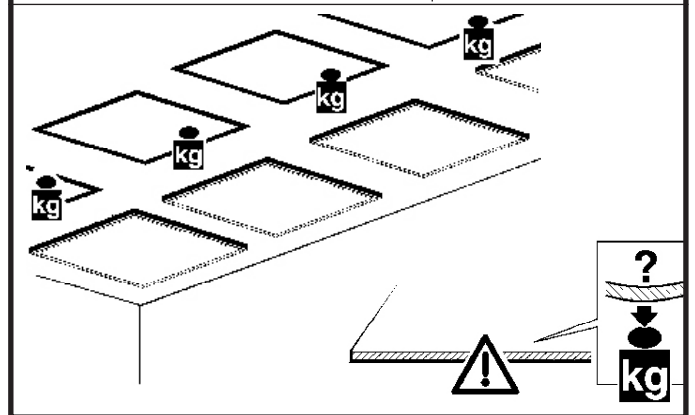
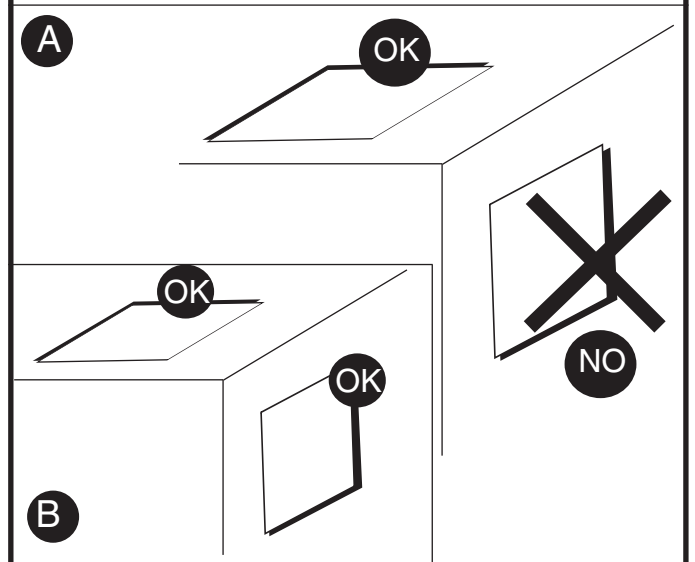
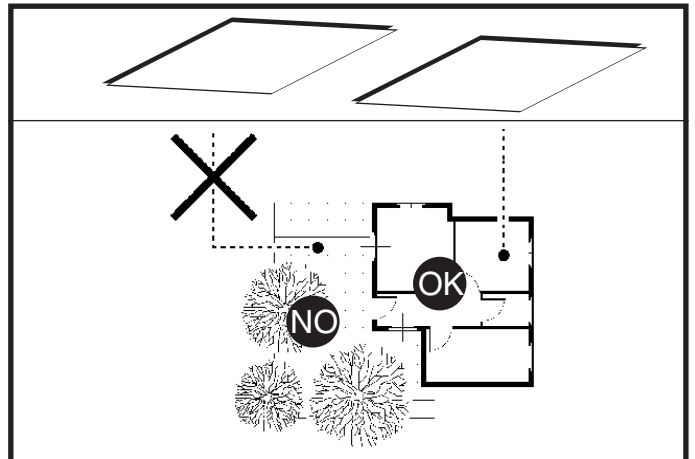

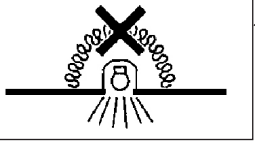
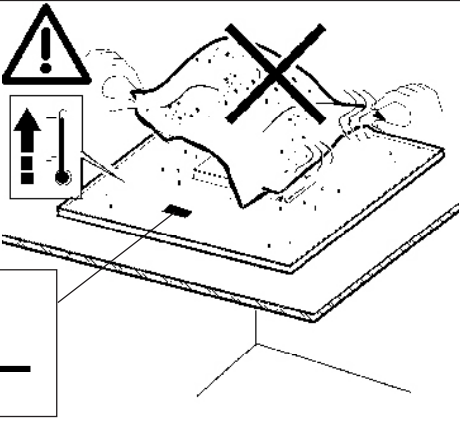

I N.B.: Apparecchi non idonei ad essere coperti di materiale termicamente isolante.  
 GB N.B.: Fixtures not suitable to be covered in thermally-insulating material.  
 F N.B.: Appareils ne pouvant pas être couverts de matériau d'isolation thermique.  
 D N.B.: Geräte nicht geeignet, um mit wärmeisolierendem Material abgedeckt zu werden.  
 NL N.B.: Deze apparaten zijn niet geschikt om te worden bedekt met thermisch isolerend materiaal.  
 E NOTA: Aparatos no aptos para ser cubiertos de material térmicamente aislante.  
 DK N.B.: Armaturerne må ikke dækkes af varmeisolerende materiale.  
 N N.B.: Apparatene passer ikke til å dekkes av termoisolerende materialer.  
 S OBS! Utrustningen får inte täckas över med värmeisolerande material.  
 RUS Прибесы не пригодны для покрытия термизолирующим материалом.  
 CN 灯具不适宜用隔热材料加以覆盖。

**A**

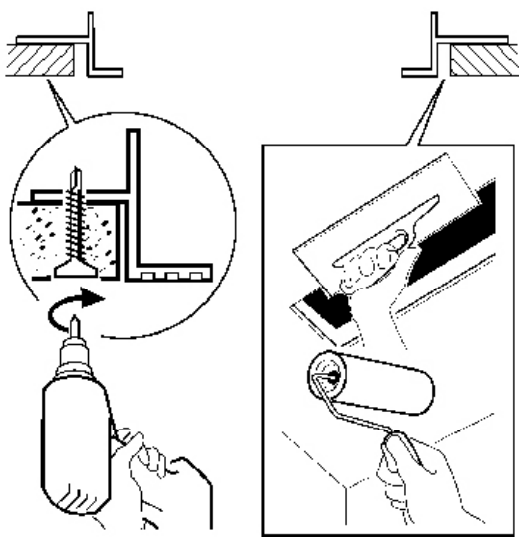
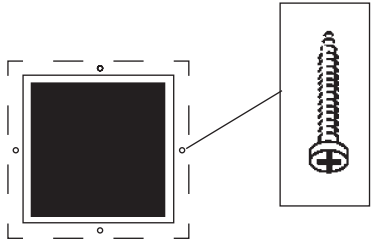
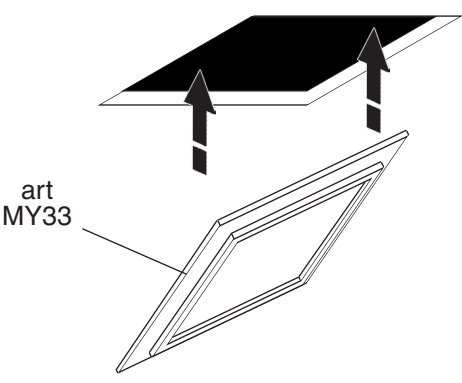
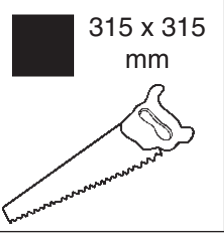
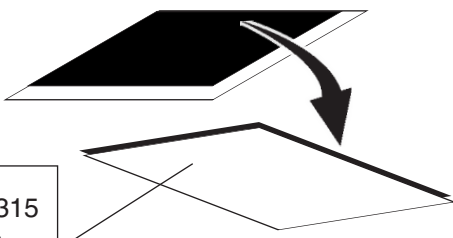

**B**

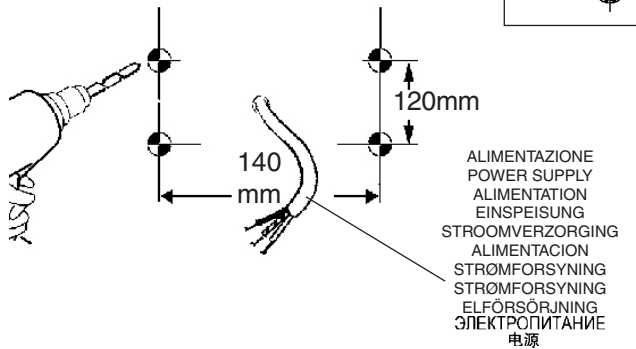
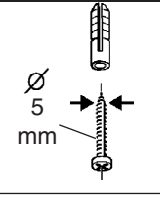

art MY32

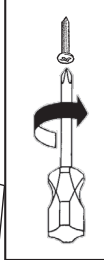
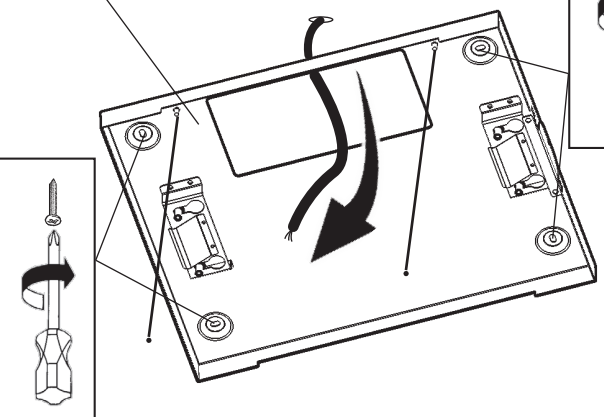

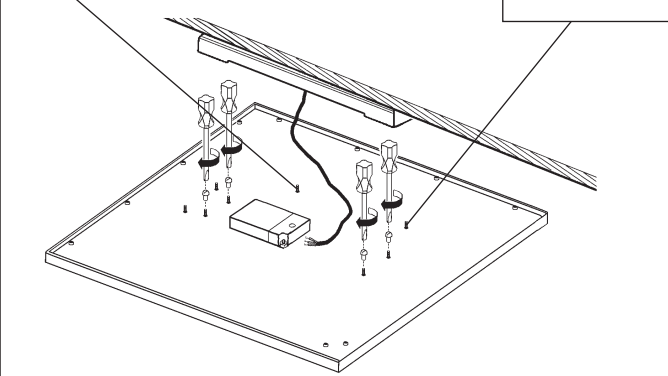
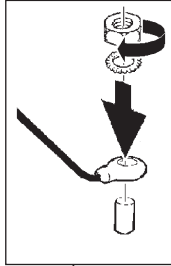
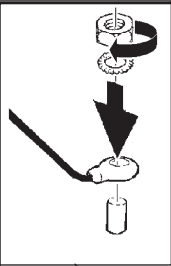
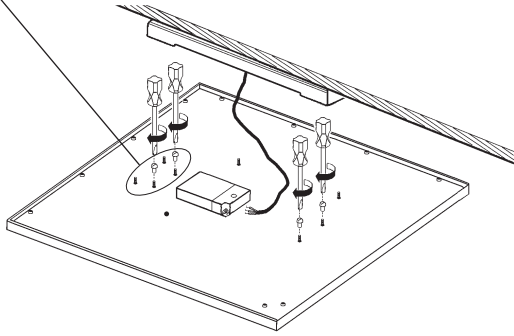
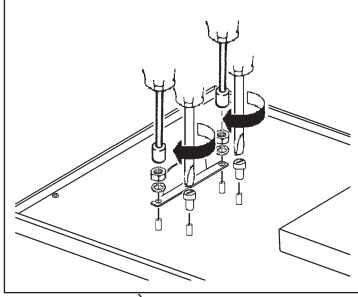

TCI

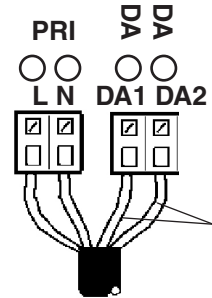
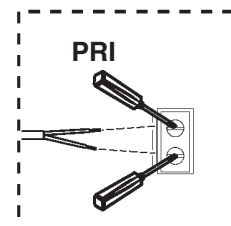
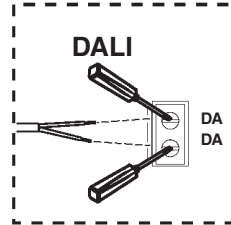
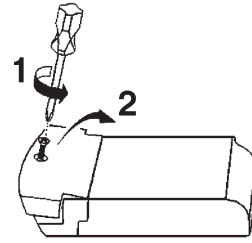
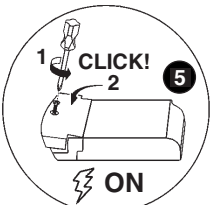
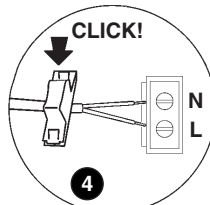
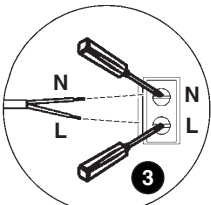
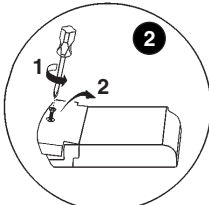
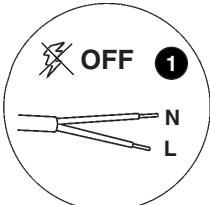

ALIMENTAZIONE  
POWER SUPPLY  
ALIMENTATION  
EINSPEISUNG  
STROMVERZORGUNG  
ALIMENTACION  
STRØMFORSYNING  
STRØMFORSYNING  
ELFORSØRNING  
ЭЛЕКТРОПИТАНИЕ  
電源

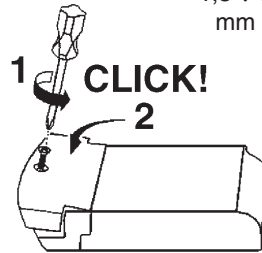
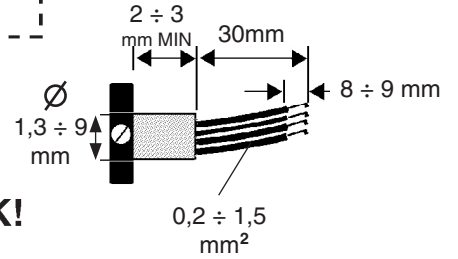

A

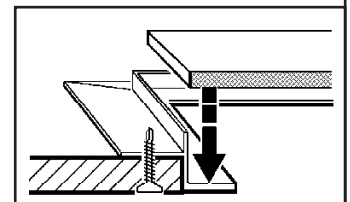
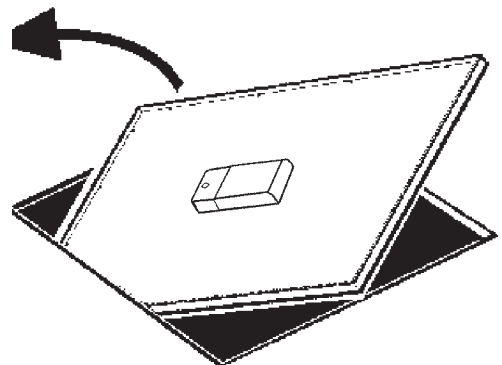

B

art. MY32

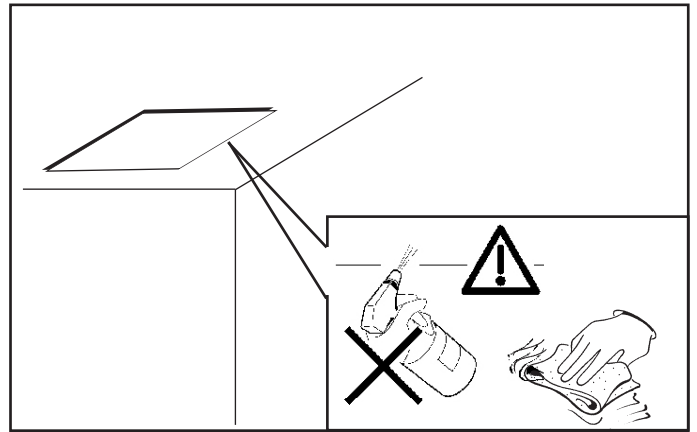
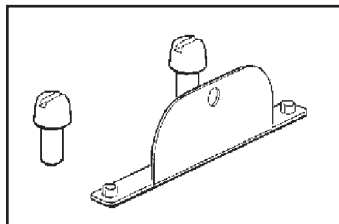
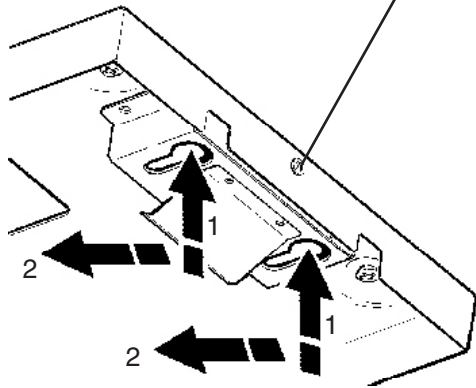
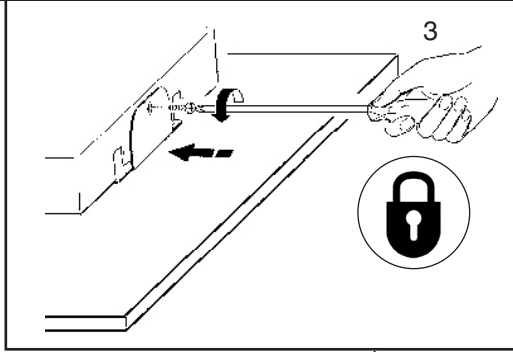

SOSTITUZIONE DEL LED  
 REPLACING THE LED  
 REMPLACEMENT DE LA LED  
 AUSTAUSCHEN DER LED  
 VERVANGEN VAN DE LED  
 REEMPLAZO DEL LED  
 UDSKIFTNING AF LYSDIODE  
 BYTE AV LYSDIOD  
 UTSKIFTING AV DEN LYSEMITTERENDE DIODEN  
 ЗАМЕНА СИДа  
 发光二极管替换

I N.B.: Per la sostituzione del LED contattare l'azienda iGuzzini.  
 GB N.B.: For information on LED replacement please contact iGuzzini.  
 F N.B.: Pour procéder au remplacement de la LED, adressez-vous à la société iGuzzini.  
 D N.B.: Bezüglich des Austausches der LED kontaktieren Sie bitte die Firma iGuzzini.  
 NL N.B.: Voor het vervangen van de LED neemt u contact op met het bedrijf iGuzzini.  
 E NOTA: Para sustituir el LED llame a la empresa iGuzzini.  
 DK N.B.: For udsiftning af lysdioden, skal man kontakte iGuzzini.  
 N N.B.: For informasjon om skifte av LED, vennligst ta kontakt med iGuzzini.  
 S OBS! För byte av lysdioden, kontakta företaget iGuzzini.  
 RUS ПРИМЕЧАНИЕ: Для замены СИДов обращайтесь в компанию iGuzzini.  
 CN 注意: 如需LED更换的信息, 请联系iGuzzini.

ART.	PESO WEIGHT POID GEWICHT GEWICHT PESO - VÆGT VEKT - VIKT BEC - 重量 ( Kg )
P612 - P613 - P614 - P615	1,5

2.526.739.01  
IS10220/01

**iGuzzini**

ART.	A	λ
MT10 - MT11 - MT14 - MT15	0,14	>0,9
MT18 - MT19 - MT22 - MT23	0,13	>0,9
MT12 - MT13 - MT16 - MT17	0,14	>0,95
MT20 - MT21 - MT24 - MT25 P178 - P179 - P180 - P223	0,12	>0,95
P612 - P613	0,08	>0,9
P614 - P615	0,07	>0,95

2.526.739.01  
IS10220/01

**iGuzzini**

ART.	A	λ
MT10 - MT11 - MT14 - MT15	0,14	>0,9
MT18 - MT19 - MT22 - MT23	0,13	>0,9
MT12 - MT13 - MT16 - MT17	0,14	>0,95
MT20 - MT21 - MT24 - MT25 P178 - P179 - P180 - P223	0,12	>0,95
P612 - P613	0,08	>0,9
P614 - P615	0,07	>0,95

2.526.739.01  
IS10220/01

**iGuzzini**

ART.	A	λ
MT10 - MT11 - MT14 - MT15	0,14	>0,9
MT18 - MT19 - MT22 - MT23	0,13	>0,9
MT12 - MT13 - MT16 - MT17	0,14	>0,95
MT20 - MT21 - MT24 - MT25 P178 - P179 - P180 - P223	0,12	>0,95
P612 - P613	0,08	>0,9
P614 - P615	0,07	>0,95

2.526.739.01  
IS10220/01

**iGuzzini**

ART.	A	λ
MT10 - MT11 - MT14 - MT15	0,14	>0,9
MT18 - MT19 - MT22 - MT23	0,13	>0,9
MT12 - MT13 - MT16 - MT17	0,14	>0,95
MT20 - MT21 - MT24 - MT25 P178 - P179 - P180 - P223	0,12	>0,95
P612 - P613	0,08	>0,9
P614 - P615	0,07	>0,95

2.526.739.01  
IS10220/01

**iGuzzini**

ART.	A	λ
MT10 - MT11 - MT14 - MT15	0,14	>0,9
MT18 - MT19 - MT22 - MT23	0,13	>0,9
MT12 - MT13 - MT16 - MT17	0,14	>0,95
MT20 - MT21 - MT24 - MT25 P178 - P179 - P180 - P223	0,12	>0,95
P612 - P613	0,08	>0,9
P614 - P615	0,07	>0,95

2.526.739.01  
IS10220/01

**iGuzzini**

ART.	A	λ
MT10 - MT11 - MT14 - MT15	0,14	>0,9
MT18 - MT19 - MT22 - MT23	0,13	>0,9
MT12 - MT13 - MT16 - MT17	0,14	>0,95
MT20 - MT21 - MT24 - MT25 P178 - P179 - P180 - P223	0,12	>0,95
P612 - P613	0,08	>0,9
P614 - P615	0,07	>0,95

- I Istruzioni per le operazioni di servizio per l'apparecchio di illuminazione**  
**GB Instructions on luminaire service operations**  
**F Instructions pour les opérations de service du luminaire**  
**D Wartungsanleitung für die Leuchte**  
**NL Instructies voor de onderhoudsoperaties op de verlichtingsarmatuur**  
**E Instrucciones para las operaciones de servicio del aparato de alumbrado**  
**DK Anvisninger i serviceindgreb på belysningsarmatur**  
**N Anvisninger for betjening av lysapparatet**  
**S Instruktioner för användning av belysningsanordningen**  
**RUS Инструкция по эксплуатации осветительного прибора**  
**CN 照明装置检修操作说明**

**Sostituire la lampada parzialmente esausta**  
 Replace the partly exhausted lamp  
 Remplacer la lampe partiellement épuisée  
 Die teilweise erschöpfte Lampe austauschen  
 Vervang de gedeeltelijk lege lamp  
 Sustituir la lámpara parzialmente agotada  
 Udskift den delvist udtjente pære  
 Skifte ut den delvis utbrente lyspæren  
 Byt ut den delvis förbrukade lampan  
 Замена частично отработанной лампочки  
 更换部分老化的灯泡



**Spegnimento**  
 Switch it off  
 Extinction  
 Ausschaltung  
 Uitschakeling  
 Apagado  
 Slukning  
 Slukking  
 Släckning  
 Выключение  
 关灯

**Interrompere l'alimentazione dell'apparecchio**  
 Cut the power supply to the luminaire  
 Couper l'alimentation du luminaire  
 Stromversorgung der Leuchte unterbrechen  
 Onderbreek de voeding van het apparaat  
 Interrumpir la alimentación del aparato  
 Afbryd armaturets strømforsyning  
 Avbryte strømtilførselen til apparatet  
 Koppla från anordningens strömförsörjning  
 Отключить электропитание прибора  
 中断装置供电

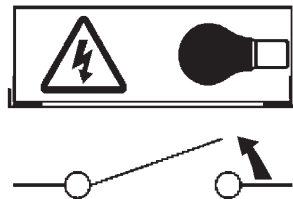

**Aprire l'apparecchio**  
 Open the fixture  
 Ouvrir le luminaire  
 Das Gerät öffnen  
 Open het apparaat  
 Abrir el aparato  
 Åbn armaturet  
 Åpne apparatet  
 Öppna anordningen  
 Раскрыть прибор  
 打开装置

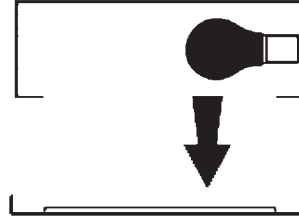

**Rimuovere la lampada esausta**  
 Remove the exhausted lamp  
 Retirer la lampe épuisée  
 Die alte Lampe entnehmen  
 Verwijder de lege lamp  
 Quitar la lámpara agotada  
 Tag den udtjente pære ud  
 Fjerne den utbrente lyspæren  
 Ta bort den förbrukade lampan  
 Вынуть старую лампочку  
 取出老化的灯泡

**Portarla in un centro di riciclaggio**  
 Carry it to a recycling centre  
 La porter dans une déchetterie pour son recyclage  
 Ordnungsgemäß entsorgen  
 Breng de lamp naar een recyclingcentrum  
 Llevarla a un centro de reciclaje  
 Aflever den på en genbrugsstation  
 Lever den til en miljøstasjon  
 Lämna in den till en återvinningsanläggning  
 Сдать ее в пункт приема утильсырья  
 将其送往回收中心

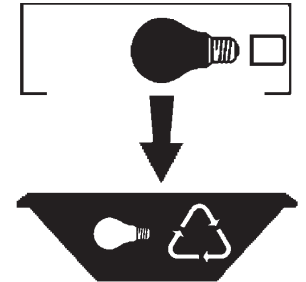

**Inserire la nuova lampada**  
 Introduce the new lamp  
 Installer la lampe neuve  
 Die neue Lampe einsetzen  
 Doe de nieuwe lamp op zijn plek  
 Montar la nueva lámpara  
 Sæt den nye pære i  
 Sette i den nye pæren  
 Sätt i den nya lampan  
 Вставить новую лампочку  
 装入新灯泡

**Inserire la nuova lampada nel portalampada**  
 Fit the new lamp into the socket  
 Installer la nouvelle lampe dans le support de lampe  
 Die neue Lampe in den Sockel einsetzen  
 Doe de nieuwe lamp in de lamphouder  
 Montar la nueva lámpara en el portalámpara  
 Sæt den nye pære i fatningen  
 Sette den nye pæren inn i lampeholderen  
 Sätt i den nya lampan i lamphållaren  
 Вставить новую лампочку в патрон  
 将新灯泡插入灯泡架中



**Riposizionare ottica**  
 Re-place the optic  
 Remettre l'optique à sa place  
 Die Optik wieder einsetzen  
 Doe de optiek weer op zijn plaats  
 Volver a montar la óptica  
 Sæt den optiske enhed på plads  
 Innstille linsen  
 Flytta om optiken  
 Отрегулировать линзы  
 重新定位光头



**Effettuare prova di funzionamento**  
 Perform operative test  
 Procéder à un essai de fonctionnement  
 Eine Funktionsprüfung durchführen  
 Controleer de correcte werking  
 Hacer una prueba de funcionamiento  
 Afprøv funktionen  
 Prøve om den fungerer  
 Utför funktionstest  
 Выполнить проверку исправности работы  
 执行功能测试



**I Istruzioni per la pulizia dell'apparecchio di illuminazione**  
**GB Instructions on luminaire cleaning operations**  
**F Instructions pour le nettoyage du luminaire**  
**D Anweisungen zur Reinigung der Leuchte**  
**NL Instructies voor de reiniging van de verlichtingsarmatuur**  
**E Instrucciones para limpiar el aparato de alumbrado**  
**DK Anvisninger i rengøring af belysningsarmaturet**  
**N Anvisninger for rengjøring av lysapparatet**  
**S Instruktioner för rengöring av belysningsanordningen**  
**RUS Инструкции по чистке осветительного прибора**  
**CN 照明装置清洁说明**

**Pulire l'apparecchio**  
**Clean the fixture**  
**Nettoyer le luminaire**  
**Das Gerät reinigen**  
**Reinig het apparaat**  
**Limpiar el aparato**  
**Rengør armaturet**  
**Rengjøre apparatet**  
**Rengör anordningen**  
**Чистка прибора**  
**清洁装置**

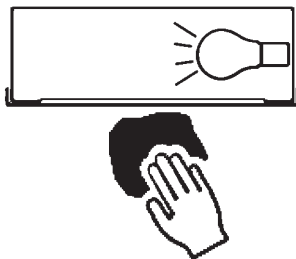

**Spegnimento**  
**Switch it off**  
**Extinction**  
**Ausschaltung**  
**Uitschakeling**  
**Apagado**  
**Slukning**  
**Slukking**  
**Släckning**  
**Выключение**  
**关灯**

**Interrompere l'alimentazione dell'apparecchio**  
**Cut the power supply to the luminaire**  
**Couper l'alimentation du luminaire**  
**Stromversorgung der Leuchte unterbrechen**  
**Onderbreek de voeding van het apparaat**  
**Interrumpir la alimentación del aparato**  
**Afbryd armaturets strømforsyning**  
**Avbryt strømtilførselen til apparatet**  
**Koppla från anordningens strömförsörjning**  
**Отключить электропитание прибора**  
**中断装置供电**



**Spolverare l'ottica esterna**  
**Remove dust from the external optic**  
**Dépoussiérer l'optique extérieure**  
**Die externe Optik abstauben**  
**Stof de externe optiek af**  
**Quitar el polvo de la óptica exterior**  
**Tør støvet af den udvendige optiske enhed**  
**Fjerne støv fra den eksterne lysenheten**  
**Damma av den yttre optiken**  
**Вытереть пыль с внешней стороны линз**  
**为外侧光头掸尘**

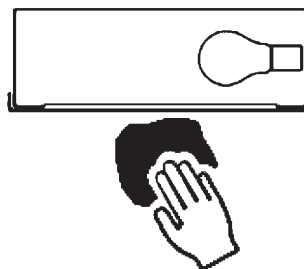

**Lavare l'ottica esterna**  
**Wash the external optic**  
**Laver l'optique extérieure**  
**Die externe Optik waschen**  
**Was de externe optiek**  
**Lavar la óptica exterior**  
**Vask den udvendige optiske enhed**  
**Vaske den eksterne lysenheten**  
**Rengör den yttre optiken**  
**Вымыть линзы с внешней стороны**  
**清洁外光头**



**Rimuovere l'ottica**  
**Remove the optic**  
**Retirer l'optique**  
**Die Optik abnehmen**  
**Verwijder de optiek**  
**Quitar la óptica**  
**Tag den optiske enhed af**  
**Fjerne lysenheten**  
**Ta bort optiken**  
**Снять линзы**  
**取下光头**



**Pulire la parte interna dell'apparecchio di illuminazione**  
**Clean the inside of the fixture**  
**Nettoyer l'intérieur du luminaire**  
**Die Innenseite der Leuchte reinigen**  
**Reinig de binnenzijde van de verlichtingsarmatuur**  
**Limpiar el interior del aparato de alumbrado**  
**Rengør belysningsarmaturets indvendige dele**  
**Rengjøre lysapparatet innvendig**  
**Rengör belysningsanordningen invändigt**  
**Протереть осветительный прибор изнутри**  
**清洁照明装置内部**



**Riposizionare ottica**  
**Re-place the optic**  
**Remettre l'optique à sa place**  
**Die Optik wieder einsetzen**  
**Doe de optiek weer op zijn plaats**  
**Volver a montar la óptica**  
**Sæt den optiske enhed på plads**  
**Innstille linsen**  
**Flytta om optiken**  
**Отрегулировать линзы**  
**重新定位光头**



**Effettuare prova di funzionamento**  
**Perform operative test**  
**Procéder à un essai de fonctionnement**  
**Eine Funktionsprüfung durchführen**  
**Controleer de correcte werking**  
**Hacer una prueba de funcionamiento**  
**Afprøv funktionen**  
**Prøve om den fungerer**  
**Utför funktionstest**  
**Выполнить проверку исправности работы**  
**执行功能测试**

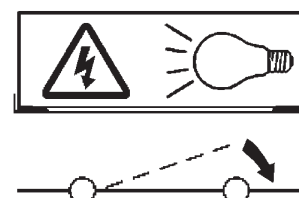

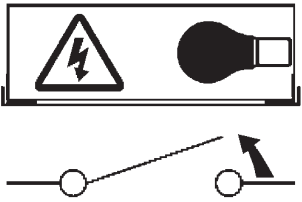
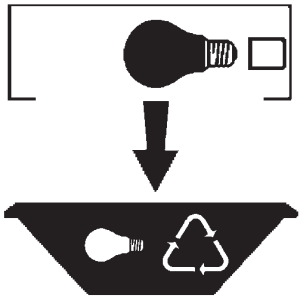
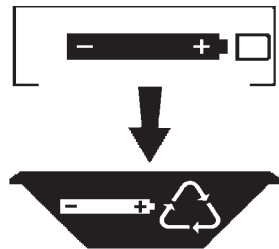
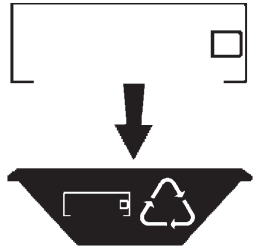

- I** Istruzioni per il fine vita e lo smaltimento dei componenti  
**GB** Instructions on end-of-life and component disposal  
**F** Instructions pour la gestion des composants en fin de vie et leur mise au rebut  
**D** Anweisungen zur Entsorgung der Leuchtenkomponenten  
**NL** Instructies voor het verwijderen van de armatuur en het recyclen van de onderdelen  
**E** Instrucciones para el final de vida y la eliminación los componentes  
**DK** Anvisninger i udtjent armatur og bortskaffelse af komponenter  
**N** Anvisninger for endt levetid og avfallsbehandling av delene  
**S** Instruktioner vid bortskaffning och kassering av komponenter  
**RUS** Инструкции по утилизации прибора и его комплектующих по окончании его срока службы  
**CN** 寿命期结束与零件废弃处置说明

<p>Spegnimento Switch it off Extinction Ausschaltung Uitschakeling Apagado Slukning Slukking Släckning Выключение 关灯</p> <p>Interrompere l'alimentazione dell'apparecchio Cut the power supply to the luminaire Couper l'alimentation du luminaire Stromversorgung der Leuchte unterbrechen Onderbreek de voeding van het apparaat Interrompirla alimentación del aparato Afbryd armaturets strømforsyning Avbryt strømtilførselen til apparatet Koppla från anordningens strömförsörjning Отключить электропитание прибора 中断装置供电</p> 	<p>Rimuovere la/e lampada/e per la dismissione Remove the lamp(s) for decommissioning Retirer la(les) lampe(s) pour sa(leur) mise au rebut Die Lampe/n ordnungsgemäß entsorgen Verwijder de lamp(en) voor het recyclen Quitar la(s) lámpara(s) para el desecho Tag pæren/pærerne ud til bortskaffelse Fjerne lampen/-e som skal kastes Ta bort lampan/-orna för bortskaffningen Вынуть лампочку/и для утилизации прибора 取出需要丢弃的灯泡</p> 	<p>Rimuovere la batteria per la dismissione Remove the battery for decommissioning Retirer la batterie pour sa mise au rebut Die Batterie ordnungsgemäß entsorgen Verwijder de batterij voor het recyclen Quitar la batería para el desecho Tag batteriet ud til bortskaffelse Fjerne batteriet som skal kastes Ta bort batteriet för bortskaffningen Вынуть батарейку для утилизации прибора 取出需要丢弃的电池</p> 	<p>Rimuovere l'apparecchio per la dismissione Remove the fixture for decommissioning Enlever le luminaire pour sa mise au rebut Das Gerät ordnungsgemäß entsorgen Verwijder het apparaat voor het recyclen Quitar el aparato para el desecho Tag armaturet ud til bortskaffelse Fjerne apparatet som skal kastes Ta bort anordningen för bortskaffningen Снять прибор для утилизации 取出需要丢弃的装置</p> 
---	--	--	--

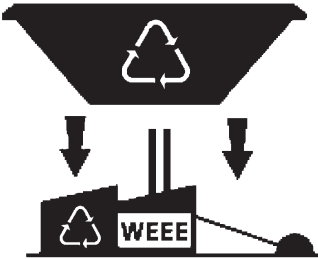
<p>Inviare i materiali ad un centro di raccolta RAEE Send the materials to a WEEE collection centre Envoyer les matériaux dans une déchetterie DEEE Die Materialien in einem WEEE-Zentrum entsorgen Zend de materialen naar een recyclingscentrum voor de AEEA Enviar los materiales a un centro de recogida RAEE Afløver materialerne på et indsamlingscenter for elektronisk udstyr Sende materialene til en miljøstasjon for resirkulering av EE-avfall Skicka materialet till en RAEE uppsamlingscentral Сдать материалы в пункт приема утильсырья 将材料送往电气和电子垃圾回收中心</p> 			
--	--	--	--