

## THE REFLEX LED COB FISSI/WALL WASHER



MINIMAL  
78/104/134/152



FRAME  
75/96/125/153/212/242



**I ATTENZIONE:**

LA SICUREZZA DELL'APPARECCHIO E' GARANTITA SOLO CON L'USO APPROPRIATO DELLE SEGUENTI ISTRUZIONI; PERTANTO E' NECESSARIO CONSERVARLE.

**GB WARNING:**

THE SAFETY OF THIS FIXTURE IS GUARANTEED ONLY IF YOU COMPLY WITH THESE INSTRUCTIONS; REMEMBER TO CONSERVE IN A SAFE PLACE.

**F ATTENTION:**

LA SECURITE DE L'APPAREIL N'EST GARANTIE QU'EN CAS D'UTILISATION CORRECTE DES INSTRUCTIONS SUIVANTES; IL FAUT PAR CONSEQUENT LES CONSERVER.

**D ACHTUNG:**

DIE SICHERHEIT DES GERÄTES WIRD NUR DURCH SACHGEMÄSSE BEFOLGUNG NACHSTEHENDER ANWEISUNGEN GEWÄHRLEISTET; IHRE AUFBEWAHRUNG IST DESHALB SEHR WICHTIG.

**NL OPGELET:**

DE VEILIGHEID VAN DI ATOESTEL IS SLECHTS DAN GEGARANDEERD ALS INDIEN DE VOLGENDE INSTRUCTIES STRIKT WORDEN TOEGEPAST; DAAROM MOET MEN ZE OOK BEWAREN.

**E ATENCION:**

LA SEGURIDAD DEL APARATO SE GARANTIZA SOLO CUMPLIENDO CUIDADOSAMENTE LAS SIGUIENTES INSTRUCCIONES; POR ELLO, ES NECESARIO CONSERVARLAS.

**DK BEMÆRK:**

SIKKERHEDEN VED BRUG AF ARMATURET KAN KUN GARANTERES, HVIS DISSE ANVISNINGER FØLGES; SØRG DERFOR FOR AT GEMME DEM.

**N ADVARSEL:**

SIKKERHETEN TIL DETTE APPARATET GARANTERES KUN HVIS DU OVERHOLDER DISSE INSTRUKSJONENE; HUSK Å OPPBEVARE DEM PÅ ET TRYGT STED.

**S OBSERVERA!**

UTRUSTNINGENS SÄKERHET KAN ENDAST GARANTERAS OM DESSA ANVISNINGAR RESPEKTERAS I DETALJ. SPARA DÄRFÖR DESSA ANVISNINGAR FÖR FRAMTIDA KONSULTATION.

**RUS ВНИМАНИЕ:**

МЫ ГАРАНТИРУЕМ БЕЗОПАСНУЮ ЭКСПЛУАТАЦИЮ ИЗДЕЛИЯ ТОЛЬКО ПРИ СОБЛЮДЕНИИ СЛЕДУЮЩИХ ИНСТРУКЦИЙ; С ЭТОЙ ЦЕЛЬЮ НЕОБХОДИМО СОХРАНИТЬ ДАННУЮ БРОШЮРУ.

**CN 警告**

为确保该装置安全，请遵守操作指示；并于安全场所放置。



N.B.: DURANTE L'INSTALLAZIONE DEL SISTEMA RISPETTARE SCRUPolosAMENTE LE NORME IMPIANTISTICHE NAZIONALI VIGENTI.

N.B.: WHEN INSTALLING THE SYSTEM, MAKE SURE ALL CURRENT NATIONAL REGULATIONS RELATING TO INSTALLATION ARE OBSERVED.

N.B.: LORS DE L'INSTALLATION DU SYSTÈME VEUILLEZ RESPECTER RIGOREUSEMENT LES NORMES EN VIGUEUR EN LA MATIÈRE DANS LE PAYS.

N.B.: BEACHTEN SIE BEI DER INSTALLATION DES SYSTEMS UNBEDINGT DIE IM LAND GELTENDEN ANLAGETECHNISCHEN VORSCHRIFTEN.

N.B.: BIJ HET INSTALLEREN VAN HET SYSTEEM MOET U DE GELDENDE NATIONALE INSTALLATIENORMEN STRIKT NALEVEN.

NOTA: DURANTE LA INSTALACIÓN DEL SISTEMA RESPETAR ESCRUPolosAMENTE LAS NORMAS NACIONALES DE INSTALACIÓN EN VIGOR.

N.B.: UNDER INSTALLATION AF SYSTEMET SKAL MAN NØJE OVERHOLDE DE GÆLDENDE REGLER FOR DISSE ANLÆG.

N.B.: UNDER INSTALLASJON AV SYSTEMET MÅ DE NASJONALE ANLEGGSFORSKRIFTE NE OVERHOLDES NØYE.

OBS! UNDER INSTALLATIONEN AV SYSTEMET SKA GÄLLANDE NATIONELLA INSTALLATIONSFÖRESKRIFTER RESPEKTERAS I DETALJ.

ПРИМЕЧАНИЕ: В ПРОЦЕССЕ МОНТАЖА СИСТЕМЫ СТРОГО СОБЛЮДАЙТЕ НАЦИОНАЛЬНЫЕ ДЕЙСТВУЮЩИЕ НОРМАТИВЫ ПО ЭЛЕКТРОПРОВОДКЕ.

注意：安装系统时请务必遵守系统标准。



Ø	ART.	X max mm	Y max mm
96	N121-N122-N123-N124-N125-Q978	850	900
125	N111 - N112 - N113 - N114 - N115 N239 - N240 - N241 - N242 - N243 N244 - N245 - N246 - N247 - N248 N126 - N127 - N128 - N129 - N130 Q979-Q980-Q981-Q982		
153	N116 - N117 - N118 - N119 - N120 N131 - N132 - N133 - N134 - N135 Q983-Q984	1000	1150
212	MN01 - MN02 - MN03 - MN04 - N136	1100	1200





- I N.B.: Apparecchi non idonei ad essere coperti di materiale termicamente isolante.
- GB N.B.: Fixtures not suitable to be covered in thermally-insulating material.
- F N.B.: Appareils ne pouvant pas être couverts de matériau d'isolation thermique.
- D N.B.: Geräte nicht geeignet, um mit wärmeisolierendem Material abgedeckt zu werden.
- NL N.B.: Deze apparaten zijn niet geschikt om te worden bedekt met thermisch isolerend materiaal.
- E NOTA: Aparatos no aptos para ser cubiertos de material térmicamente aislante.
- DK N.B.: Armaturerne må ikke dækkes af varmeisolerende materiale.
- N N.B.: Apparatene passer ikke til å dekkes av termoisolerende materialer.
- S OBS! Utrustningen får inte täckas över med värmeisolerande material.
- RUS Приборы, непригодные для покрытия термоизоляционным материалом.
- CN 灯具不适宜用隔热材料加以覆盖

Art. MV78-MV79-MV80-MV81-MV82-MV83-MV84-MV85-MV86-MV87  
 MV88-MV89-MV90-MV91-MV92-MV93-MV94-MV95-MV96-MV97  
 MV98-MV99-N000-N001-N002-N003-N004-N005-N229-N230-N231  
 N232-N233-N234-N235-N236-N237-N238-N006-N007-N008-N009  
 N010-N011-N012-N013-N014-N015-N224-MM97-M225-MM98-N226  
 MM99-N227-MN00-N228-N016-M636-P586-P587-P588-P589-P507-  
 P508-P509-P510-P511-P512-P513-P514-P515-P516-P517-P518  
 P519-P520-P521-P522-P523-P524-P525-P526-P527-P528-P529-P530  
 P531-P532-P533-Q959-Q960-Q961-Q964-Q965-Q966-Q967-Q968-Q969  
 Q974-Q975



Art. N017-N018-N019-N020-N021-N022-N023-N024



Art. MV40-MV41-MV42-MV43-MV44-MV45-MV46-MV47-MV48-MV49  
 MV50-MV51-MV52-MV53-MV54-MV55-MV56-MV57-N121-N122-N123  
 N124-N125-MV58-MV59-MV60-MV61-MV62-MV63-MV64-MV65-MV66  
 MV67-N111-N112-N113-N114-N115 N214-N215-N216-N217-N218  
 N219-N220-N221-N222-N223-N239-N240-N241-N242-N243-N244-N245  
 N246-N247-N248-MV68-MV69-MV70-MV71-MV72-MV73-MV74-MV75  
 MV76-MV77-N116-N117-N118-N119-N120-N131-N132-N133-N134  
 N135-MN01-MN02-MN03-MN04-N136  
 Q962-Q963-Q970-Q971-Q972-Q973-Q976-Q977



Frame

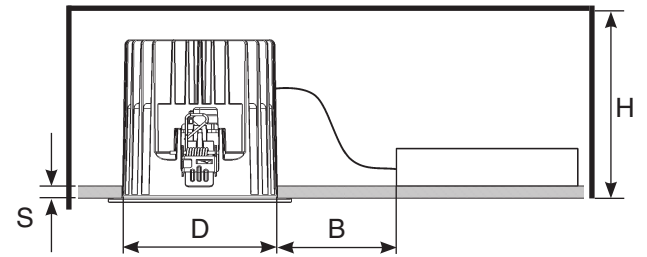
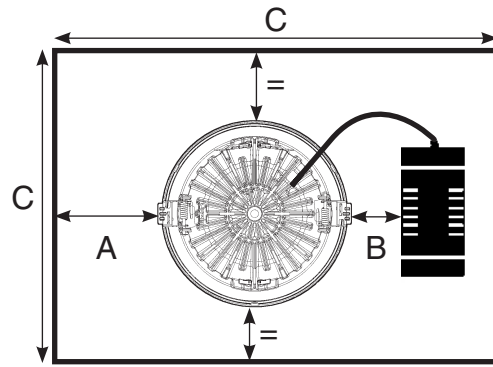

Minimal

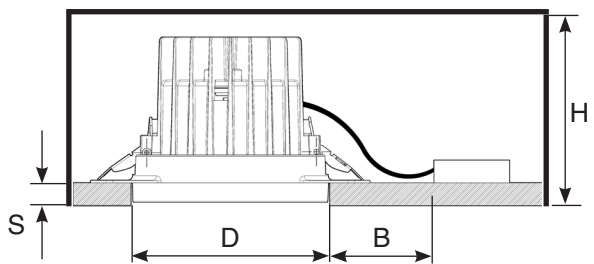

ART.	∅ D mm	S mm	H mm	A mm	B mm	C mm
MV40-MV41-MV42-MV43 MV44-MV45-MV46-MV47	78 <sup>±1</sup>	12,5	100	50	100	350
MV78-MV79-MV80-MV81-P586-P587 MV82-MV83-MV84-MV85-P588-P589	75 <sup>+2-0</sup>	1±20	100		100	350
MV48-MV49-MV50-MV51- MV52 MV53-MV54-MV55-MV56-MV57 Q962-Q963	104 <sup>±1</sup>	12,5	100		100	350
MV86-MV87-MV88-MV89-MV90-P507 MV91-MV92-MV93-MV94-MV95-P508 N121-N122-N123-N124-N125-P509-P510 Q959-Q960-Q961-Q978	96 <sup>+2-0</sup>	1+20	100		100	350
MV58-MV59-MV60-MV61-MV62 MV63-MV64-MV65-MV66-MV67 N111-N112-N113-N114-N115-N214 N215-N216-N21-N218-N219-N220 N221-N222-N223-N239-N240 N241-N242-N243 Q970-Q971-Q972-Q973-Q981-Q982	134 <sup>±1</sup>	12,5	111		100	350
MV96-MV97-MV98-MV99-N000-P511 N001-N002-N003-N004-N005-N126 N127-N128-N129-N130-N229-N230 N231-N232-N233-N234-N235-N236 N237-N238-N244-N245-P512-P513 N246-N247-N248-P514-P515-P516 P517-P518 - P523 - P524 - P525 P526-P527-P528-Q964-Q965-Q966-Q967 Q968-Q969-Q979-Q980	125 <sup>+2-0</sup>	1+20	109		100	350
MV68-MV69-MV70-MV71-MV72 MV73-MV74-MV75-MV76-MV77 N116-N117-N118-N119-N120 Q976-Q977-Q984	152 <sup>±1</sup>	12,5	125		100	500
N006-N007-N008-N009-N010-N011 N012-N013-N014-N015-N131-N132 N133-N134-N135 Q974-Q975-Q983	153 <sup>+2-0</sup>	1+25	123		100	500
N224-N225-N226-N227-P519-P520 MM97-MM98-MM99-MN00-P521 MN01-MN02-MN03-MN04-P522	212 <sup>+2-0</sup>	1+25	150		150	600
N228-N016 - M636-N136-P529 P530-P531-P532-P533	212 <sup>+2-0</sup>	1+25	190		150	600
N017-N018-N019-N020 N021-N022-N023-N024	242 <sup>+2-0</sup>	1+25	250	150	600	

96 / 125 / 153 / 212  
104 / 134 / 152

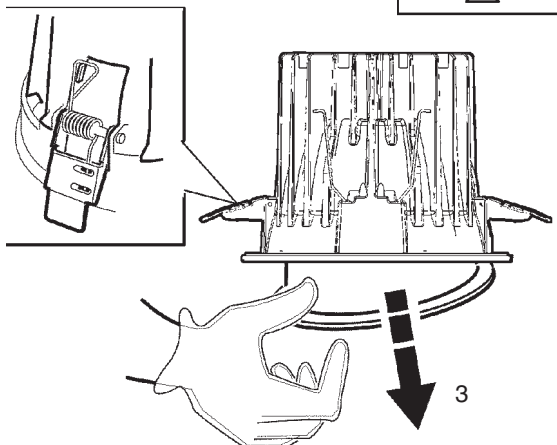

∅ 75/78



∅ 242

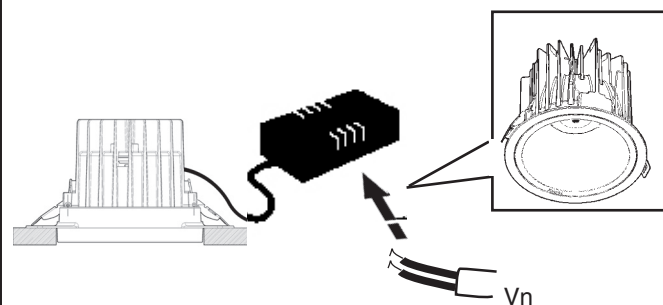
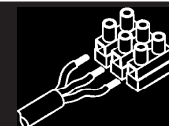
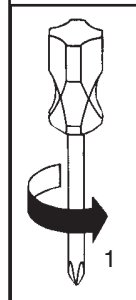



- I Per il collegamento elettrico fare riferimento alla marcatura dell'alimentatore.  
 GB Refer to the marking on the power unit for the electrical connection.  
 F Pour le raccordement électrique se reporter au marquage du ballast.  
 D Den Anschluss an das Stromnetz gemäß Kennzeichnung auf dem Vorschaltgerät ausführen.  
 NL Voor de elektrische aansluiting wordt verwezen naar de markering op de stroomvoorziening.  
 E Para la conexión eléctrica hacer referencia a las informaciones marcadas en el alimentador.  
 DK For elektrisk tilslutning, se strømforsynings mærkning.  
 N For elektrisk tilkobling, se merking på strømforsyningsenheten.  
 S För elanslutningen se till märkningarna på nätdelen.  
 RUS Для электрического подключения смотреть маркировку на блоке питания.  
 CN 连接电线时请参照供电装置上的标记。

	S mm <sup>2</sup>	Y mm	X mm	D mm
* TCI DC MAXI JOLLY	0,5 - 2,5	6 ± 0,5		3 - 8
OSRAM OT Fit		9 ± 0,5	~ 30	/
OSRAM OT i DALI	0,5 - 1,5	8 - 9		7 - 11
PHILIPS Xitanium LH		9 ± 0,5	~ 25	/
PHILIPS Xitanium .... / m	0,2 - 1,5	8,5 - 9,5		/
PHILIPS SH	0,75 - 2,5	10 - 11	~ 40	
TRIDONIC LCAI - LCI	0,5 - 2,5		~ 30	10 - 11
TRIDONIC LC		8,5 - 9,5	~ 40	/
OSRAM OTe 35	0,5 - 1,5	8 - 9	~ 30	/

- I Pilotare diversi prodotti DALI tramite pulsante (es: Touch-dim, Switch-dim, Push-dim, Direct-dim, etc.) potrebbe causare dei problemi di sincronizzazione tra gli stessi. È possibile ovviare a questo problema dotandosi di dispositivi aggiuntivi. Per maggiori informazioni vi invitiamo a contattarci direttamente.  
 GB Controlling different DALI products through buttons (e.g.: Touch-dim, Switch-dim, Push-dim, Direct-dim, etc.) may lead to product synchronisation problems. This problem can be overcome by using additional devices. For further information, please contact us directly.  
 F Piloter plusieurs produits DALI par bouton (ex : Touch-dim, Switch-dim, Push-dim, Direct-dim, etc.) pourrait causer des problèmes de synchronisation entre eux. Ce problème peut être évité en s'équipant de dispositifs supplémentaires. Pour de plus amples renseignements, veuillez nous contacter directement.  
 D Die Steuerung verschiedener DALI-Produkte mittels Taste (z.B.: Touch-dim, Switch-dim, Push-dim, Direct-dim etc.) kann eventuell zu Synchronisierungsproblemen zwischen diesen führen. Dieses Problem lässt sich durch den Einsatz von zusätzlichen Geräten beheben. Wenn Sie weitere Informationen wünschen, setzen Sie sich bitte direkt mit uns in Verbindung.  
 NL Het besturen van verschillende DALI producten m.b.v. dezelfde knop (bv.: Touch-dim, Switch-dim, Push-dim, Direct-dim, etc.) kan synchronisatieproblemen tussen de producten opleveren. Men kan dit probleem voorkomen door extra systemen aan te sluiten. Voor verdere informatie raden we u aan direct contact met ons op te nemen.  
 E El mando de varios productos DALI por tecla (ej: Touch-dim, Switch-dim, Push-dim, Direct-dim, etc.) podría causar problemas de sincronización entre ellos. Es posible prevenir este problema utilizando dispositivos adicionales. Para más información, contacte directamente con nosotros.  
 DK Hvis DALI-produkterne styres ved hjælp af knapperne (fx. Touch-dim, Switch-dim, Push-dim, Direct-dim osv.), kan det skabe problemer med synkronisering af samme. Dette problem kan undgås, hvis man køber ekstra enheder. For yderligere oplysninger, kontakt os direkte.  
 N Å styre ulike DALI-produkter ved hjelp av en trykknappbryter (f.eks. touch-dim, switch-dim, push-dim, direct-dim, osv.) vil kunne føre til problemer med synkroniseringen mellom dem. Dette problemet kan løses ved hjelp av noen tilleggsinnretninger. Ta gjerne kontakt med oss for mer informasjon om dette.  
 S Styring av olika DALI-produkter med knapp (t.ex.: Touch-dim, Switch-dim, Push-dim, Direct-dim o.s.v.) kan orsaka synkroniseringsproblem mellan dessa. Detta problem kan åtgärdas med tilläggsanordningar. För mer information kan du kontakta oss direkt.  
 RUS Управление различными продуктами DALI с помощью кнопки (напр.: Touch-dim, Switch-dim, Push-dim, Direct-dim и пр.) может вызвать проблемы синхронизации между ними. Эту проблему можно устранить путем задействования дополнительных устройств. За получением более подробной информации просим Вас связаться с нами непосредственно.  
 CN 通过按钮控制不同的 DALI 产品 (例如: 触摸调光、切换调光、按压调光、直接调光等) 可能会导致产品的同步问题。该问题可通过使用其他额外的装置加以克服。如需了解更多信息, 请直接与我们联系。

### DALI

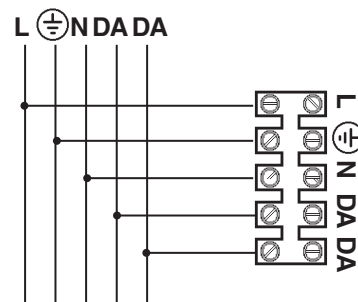

### SWITCH DIM / TOUCH DIM

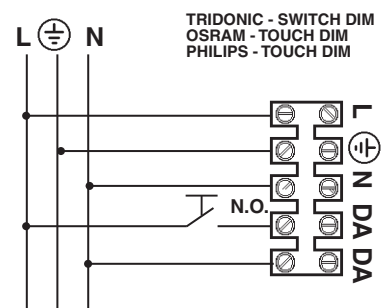

- I I dispositivi con cablaggio digitale possono essere dimmerati con dispositivi DALI o con pulsante normalmente aperto (N.O.) da collegare come da schema.  
 GB Devices with digital control gear may be dimmed using DALI devices or a normally-open button (N.O.) to be connected as shown in the diagram.  
 F Les articles à câblage numérique peuvent fonctionner avec des variateurs à dispositifs DALI ou à bouton poussoir normalement ouvert (N.O.) à relier conformément au schéma.  
 D Die Geräte mit digitaler Verkabelung können mit Hilfe von DALI-Vorrichtungen oder mit Hilfe eines gemäß Schaltplan anzuschließenden Schließers (N.O.) gedimmt werden.  
 NL De producten met digitale bekabeling kunnen worden gedimd met DALI systemen of met een N.O. (normally open) knop, die moet worden aangesloten volgens schema.  
 E Los dispositivos con cableado digital pueden regularse con dispositivos DALI o con un interruptor de botón normalmente abierto (N.O.) que se conecta según ilustrado en el esquema.  
 DK Produkter med digital kabelføring kan dæmpes med DALI-anordninger eller med kontakten, som normalt er åben (N.O.) og som skal tilsluttes, som vist.  
 N Produkter med digitalkabler kan dimmes med DALI-anordninger eller med en normalt åpen (NO) trykkbryter som kobles som vist i koblingsskjema.  
 S Produkter med digital kabeldragning kan förädas med dimmer. Detta kan göras med DALI-anordningarna eller med en normalt öppen kontakt (N.O.) som ska anslutas enligt schemat.  
 RUS Интенсивность приборов с цифровой проводкой может регулироваться посредством устройств DALI или нормально разомкнутой кнопкой (Н.Р.), подсоединяемой согласно схеме.  
 CN 带有数字控制装置的设备可以通过 DALI (数字化可寻址调光接口) 设备或者一个连接方式如图中所示的常开按钮 (N.O.) 进行亮度调节



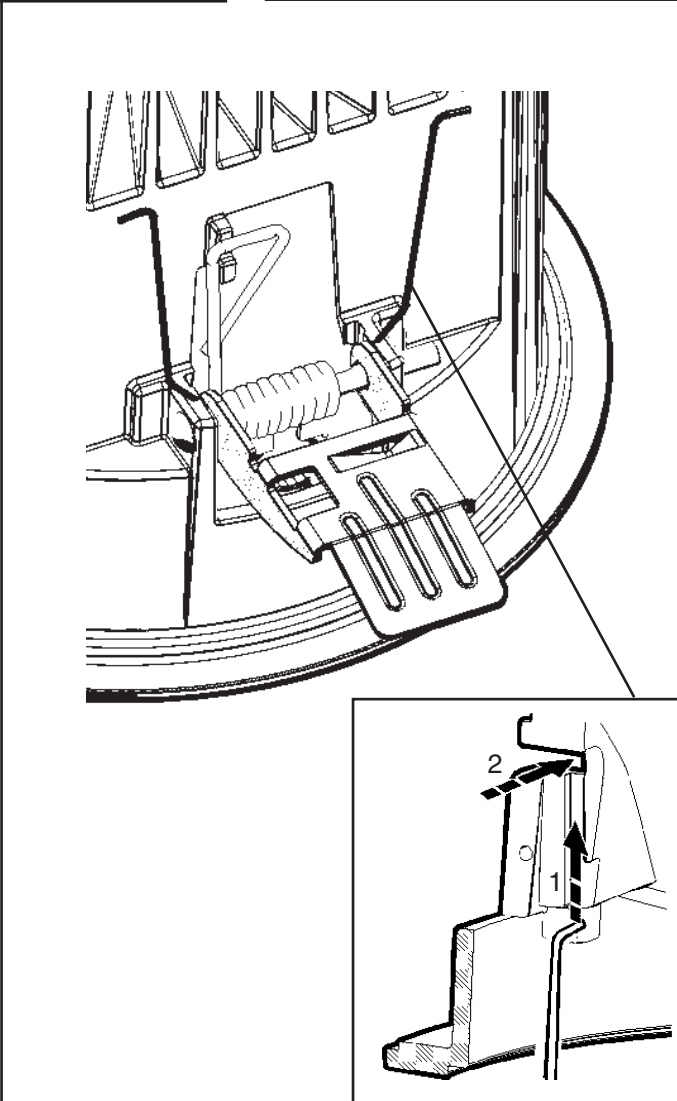

75/78

**OK**  
 VERDE  
 GREEN  
 VERT  
 GRÜN  
 GROEN  
 VERDE  
 GRÖN  
 GRÖNN  
 GRÖN  
 ЗЕЛЕНЬИЙ  
 绿色

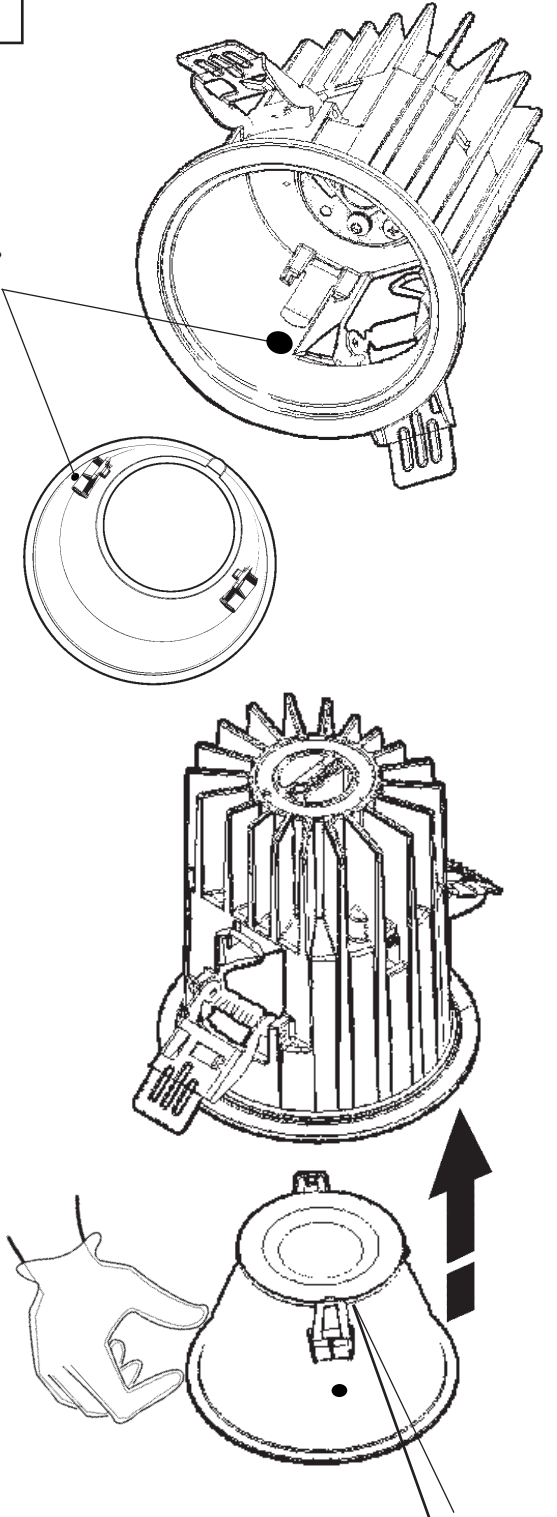

**CLICK!**

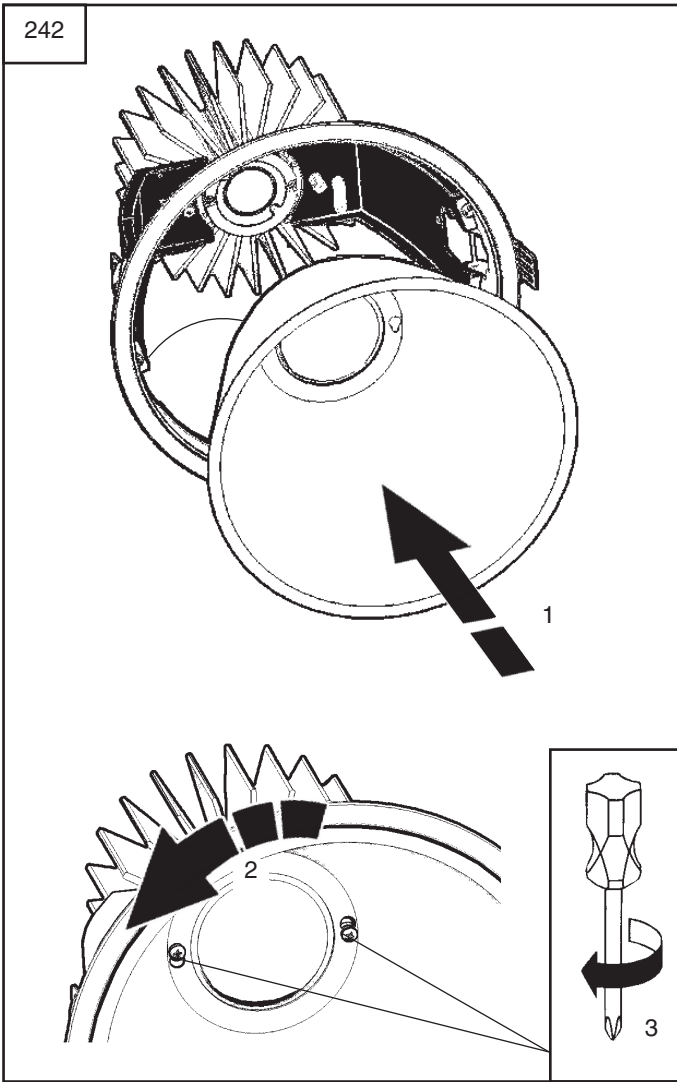

SOSTITUZIONE DEL LED  
 REPLACING THE LED  
 REMPLACEMENT DE LA LED  
 AUSTAUSCHEN DER LED  
 VERVANGEN VAN DE LED  
 REEMPLAZO DEL LED  
 UDSKIFTNING AF LYSDIODE  
 BYTE AV LYSDIOD  
 UTSKIFTNING AV DEN LYSEMITTERENDE DIODEN  
 ЗАМЕНА СИДд  
 发光二极管替换

I N.B.: Per la sostituzione del LED contattare l'azienda iGuzzini.  
 GB N.B.: For information on LED replacement please contact iGuzzini.  
 F N.B.: Pour procéder au remplacement de la LED, adressez-vous à la société iGuzzini.  
 D Ñ.B.: Bezüglich des Austausches der LED kontaktieren Sie bitte die Firma iGuzzini.  
 NL N.B.: Voor het vervangen van de LED neemt u contact op met het bedrijf iGuzzini.  
 E NOTA: Para sustituir el LED llame a la empresa iGuzzini.  
 DK N.B.: For udskiftning af lysdioden, skal man kontakte iGuzzini.  
 N N.B.: For informasjon om skifte av LED, vennligst ta kontakt med iGuzzini.  
 S OBS! För byte av lysdioden, kontakta företaget iGuzzini.  
 RUS ПРИМЕЧАНИЕ: Для замены СИДов обращайтесь в компанию iGuzzini.  
 CN 注意：如需LED更换的信息，请联系iGuzzini。

ART. 	CARICO DALI / DALI LOAD CHARGE DALI (COURANT MAXI ADMISSIBLE) DALI-LAST DALI VERMOGEN CARGA DALI DALI STRØMSTYRKE BELASTNING FOR "DALI" DALI-BELASTNING МАКС. ТОК СИСТЕМЫ DALI С РЕГУЛЯЦИЕЙ ИНТЕНСИВНОСТИ СВЕТА DALI 智能调光系统允许的最大电流量	INDIRIZZI DALI DALI ADDRESSES ADRESSES DALI DALI-ADRESSEN DALI ADRESSEN DIRECCIONES DALI DALI ADRESSER ADRESSER TIL "DALI" DALI-ADRESSER ЛОГИЧЕСКИЕ АДРЕСА СИСТЕМЫ DALI DALI智能调光系统计算机指定控制参数
	1	1

## THE REFLEX LED COB FISSI/WALL WASHER



MINIMAL  
78/104/134/152



FRAME  
75/96/125/153/212/242

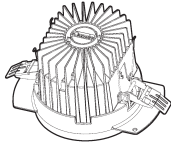

تحذير:

لا يمكن ضمان سلامة هذا الجهاز إلا إذا التزمت بهذه التعليمات. يجب حفظها في مكان آمن.

**ATTENZIONE:**

LA SICUREZZA DELL'APPARECCHIO E' GARANTITA SOLO CON L'USO APPROPRIATO DELLE SEGUENTI ISTRUZIONI; PERTANTO E' NECESSARIO CONSERVARLE.

**GB WARNING:**

THE SAFETY OF THIS FIXTURE IS GUARANTEED ONLY IF YOU COMPLY WITH THESE INSTRUCTIONS; REMEMBER TO CONSERVE IN A SAFE PLACE.

**E ATENCION:**

LA SEGURIDAD DEL APARATO SE GARANTIZA SOLO CUMPLIENDO CUIDADOSAMENTE LAS SIGUIENTES INSTRUCCIONES; POR ELLO, ES NECESARIO CONSERVARLAS.



ملاحظة: ملاحظة: أثناء تركيب نظام . يجب التقيد بحرص بالنظم السائدة المتعلقة بالشبكة الكهربائية.

N.B.: DURANTE L'INSTALLAZIONE DEL SISTEMA RISPETTARE SCRUPolosAMENTE LE NORME IMPIANTISTICHE NAZIONALI VIGENTI.

N.B.: WHEN INSTALLING THE SYSTEM, MAKE SURE ALL CURRENT NATIONAL REGULATIONS RELATING TO INSTALLATION ARE OBSERVED.

NOTA: DURANTE LA INSTALACIÓN DEL SISTEMA RESPETAR ESCRUPolosAMENTE LAS NORMAS NACIONALES DE INSTALACIÓN EN VIGOR.



WW

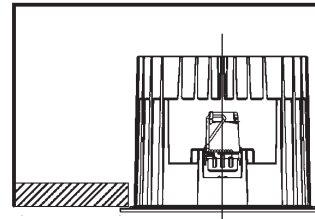

X max

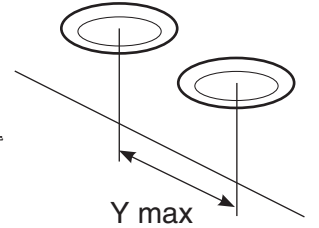

Y max

Ø	الصنف ART.	X max mm	Y max mm
96	N121-N122-N123-N124-N125-Q978		
125	N111 - N112 - N113 - N114 - N115 N239 - N240 - N241 - N242 - N243 N244 - N245 - N246 - N247 - N248 N126 - N127 - N128 - N129 - N130 Q979-Q980-Q981-Q982	850	900
153	N116 - N117 - N118 - N119 - N120 N131 - N132 - N133 - N134 - N135 Q983-Q984	1000	1150
212	MN01 - MN02 - MN03 - MN04 - N136	1100	1200

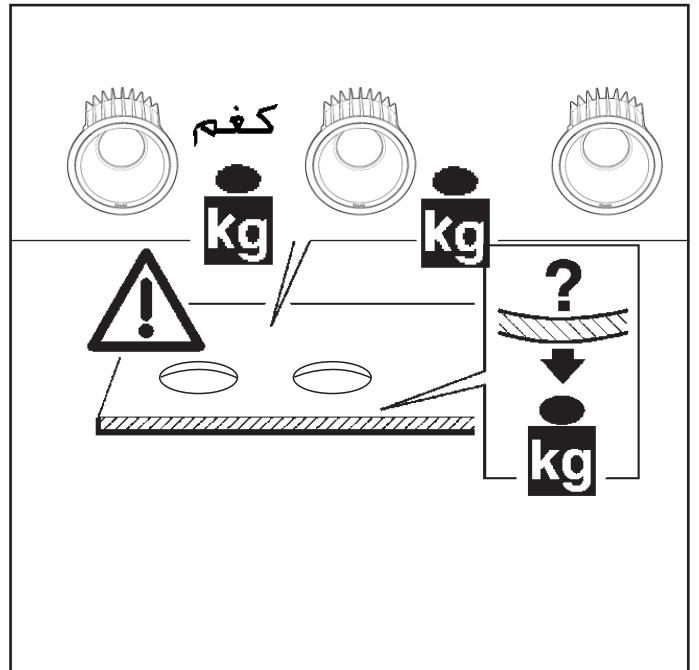
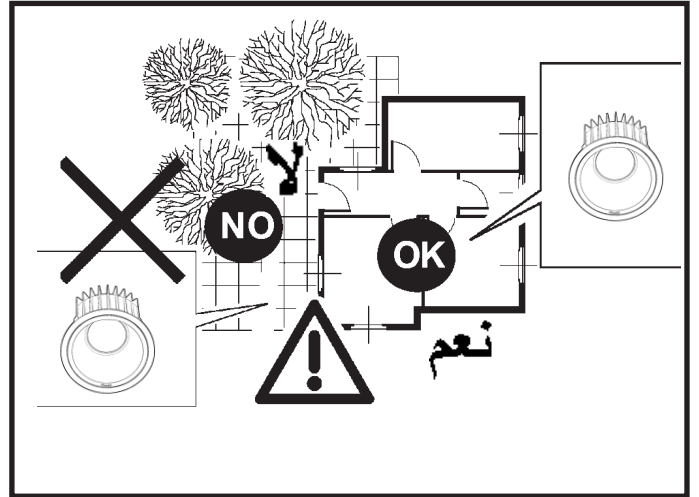



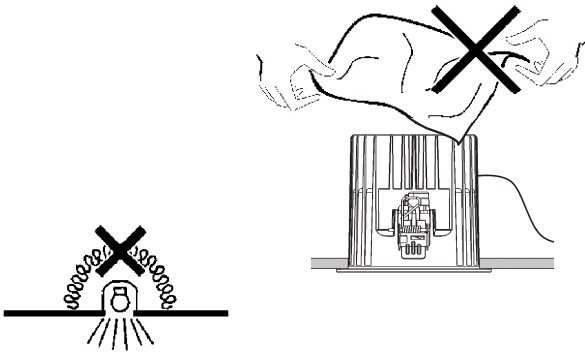

ملاحظة: أجهزة غير قابلة للتغطية بمواد عازلة حرارياً.

- I N.B.: Apparecchi non idonei ad essere coperti di materiale termicamente isolante.
- GB N.B.: Fixtures not suitable to be covered in thermally-insulating material.
- E NOTA: Aparatos no aptos para ser cubiertos de material térmicamente aislante.

Art. MV78-MV79-MV80-MV81-MV82-MV83-MV84-MV85-MV86-MV87  
 MV88-MV89-MV90-MV91-MV92-MV93-MV94-MV95-MV96-MV97  
 MV98-MV99-N000-N001-N002-N003-N004-N005-N229-N230-N231  
 N232-N233-N234-N235-N236-N237-N238-N006-N007-N008-N009  
 N010-N011-N012-N013-N014-N015-N224-MM97-M225-MM98-N226  
 MM99-N227-MN00-N228-N016-M636-P586-P587-P588-P589-P507-  
 P508-P509-P510-P511-P512-P513-P514-P515-P516-P517-P518  
 P519-P520-P521-P522-P523-P524-P525-P526-P527-P528-P529-P530  
 P531-P532-P533-Q959-Q960-Q961-Q964-Q965-Q966-Q967-Q968-Q969  
 Q974-Q975

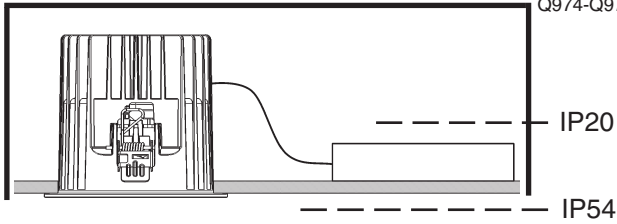

Art. N017-N018-N019-N020-N021-N022-N023-N024

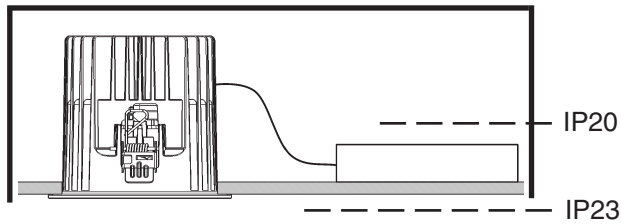

Art. MV40-MV41-MV42-MV43-MV44-MV45-MV46-MV47-MV48-MV49  
 MV50-MV51-MV52-MV53-MV54-MV55-MV56-MV57-N121-N122-N123  
 N124-N125-MV58-MV59-MV60-MV61-MV62-MV63-MV64-MV65-MV66  
 MV67-N111-N112-N113-N114-N115 N214-N215-N216-N217-N218  
 N219-N220-N221-N222-N223-N239-N240-N241-N242-N243-N244-N245  
 N246-N247-N248-MV68-MV69-MV70-MV71-MV72-MV73-MV74-MV75  
 MV76-MV77-N116-N117-N118-N119-N120-N131-N132-N133-N134  
 N135-MN01-MN02-MN03-MN04-N136  
 Q962-Q963-Q970-Q971-Q972-Q973-Q976-Q977

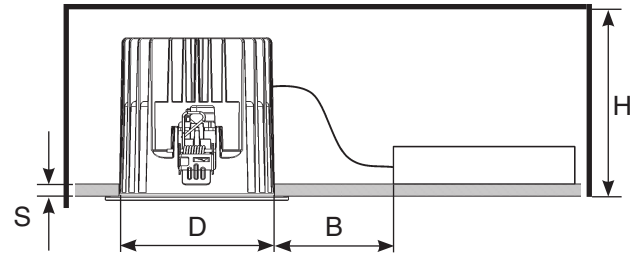
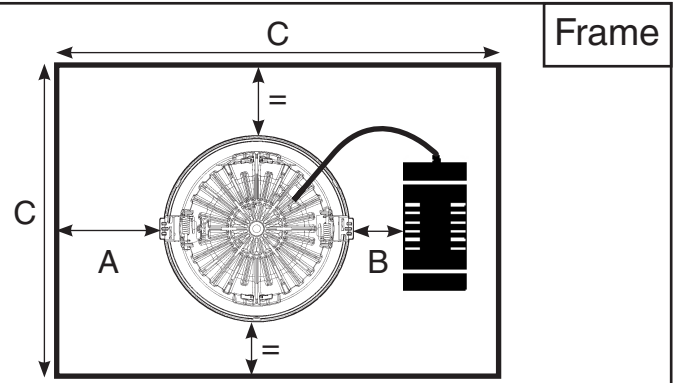
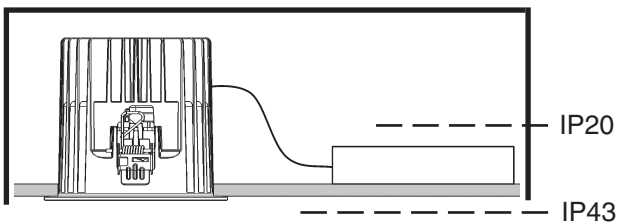

Minimal

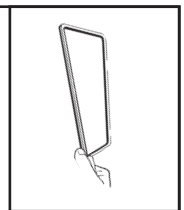
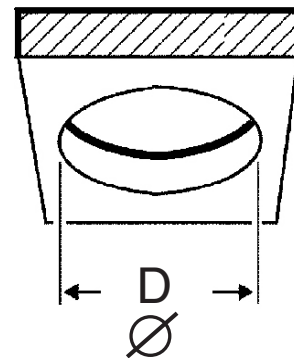
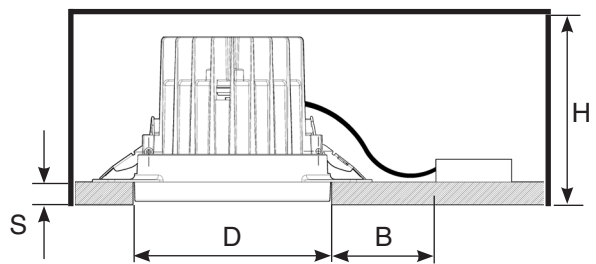
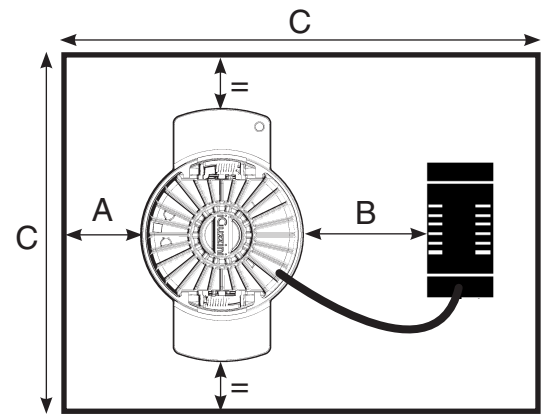

الصنف ART.	∅ D mm مم	S mm مم	H mm مم	A mm مم	B mm مم	C mm مم
MV40-MV41-MV42-MV43 MV44-MV45-MV46-MV47	78 <sup>±1</sup>	12,5	100	50	100	350
MV78-MV79-MV80-MV81-P586-P587 MV82-MV83-MV84-MV85-P588-P589	75 <sup>+2-0</sup>	1±20	100		100	350
MV48-MV49-MV50-MV51- MV52 MV53-MV54-MV55-MV56-MV57 Q962-Q963	104 <sup>±1</sup>	12,5	100		100	350
MV86-MV87-MV88-MV89-MV90-P507 MV91-MV92-MV93-MV94-MV95-P508 N121-N122-N123-N124-N125-P509-P510 Q959-Q960-Q961-Q978	96 <sup>+2-0</sup>	1±20	100		100	350
MV58-MV59-MV60-MV61-MV62 MV63-MV64-MV65-MV66-MV67 N111-N112-N113-N114-N115-N214 N215-N216-N21-N218-N219-N220 N221-N222-N223-N239-N240 N241-N242-N243 Q970-Q971-Q972-Q973-Q981-Q982	134 <sup>±1</sup>	12,5	111		100	350
MV96-MV97-MV98-MV99-N000-P511 N001-N002-N003-N004-N005-N126 N127-N128-N129-N130-N229-N230 N231-N232-N233-N234-N235-N236 N237-N238-N244-N245-P512-P513 N246-N247-N248-P514-P515-P516 P517-P518 - P523 - P524 - P525 P526-P527-P528-Q964-Q965-Q966-Q967 Q968-Q969-Q979-Q980	125 <sup>+2-0</sup>	1±20	109		100	350
MV68-MV69-MV70-MV71-MV72 MV73-MV74-MV75-MV76-MV77 N116-N117-N118-N119-N120 Q976-Q977-Q984	152 <sup>±1</sup>	12,5	125		100	500
N006-N007-N008-N009-N010-N011 N012-N013-N014-N015-N131-N132 N133-N134-N135 Q974-Q975-Q983	153 <sup>+2-0</sup>	1±25	123		100	500
N224-N225-N226-N227-P519-P520 MM97-MM98-MM99-MN00-P521 MN01-MN02-MN03-MN04-P522	212 <sup>+2-0</sup>	1±25	150		150	600
N228-N016 - M636-N136-P529 P530-P531-P532-P533	190					
N017-N018-N019-N020 N021-N022-N023-N024	242 <sup>+2-0</sup>	1±25	250	150	600	





	S mm <sup>2</sup> ملم <sup>2</sup>	Y mm ملم	X mm ملم	D mm ملم
* TCI DC MAXI JOLLY	0,5 - 2,5	6 ± 0,5		3 - 8
OSRAM OT Fit		9 ± 0,5	~ 30	/
OSRAM OT i DALI	0,5 - 1,5	8 - 9		7 - 11
PHILIPS Xitanium LH		9 ± 0,5	~ 25	/
PHILIPS Xitanium .... / m	0,2 - 1,5	8,5 - 9,5		/
PHILIPS SH	0,75 - 2,5	10 - 11	~ 40	/
TRIDONIC LCAI - LCI	0,5 - 2,5		~ 30	10 - 11
TRIDONIC LC	0,5 - 1,5	8,5 - 9,5	~ 40	/
OSRAM OTe 35		8 - 9	~ 30	/

للتوصيل بالكهرباء قم بالرجوع إلى العلامة المتواجدة على وحدة التغذية.

I Per il collegamento elettrico fare riferimento alla marcatura dell'alimentatore.

GB Refer to the marking on the power unit for the electrical connection.

E Para la conexión eléctrica hacer referencia a las informaciones marcadas en el alimentador.

يمكن أن يتسبب التحكم في منتجات "دالي" المختلفة عن طريق الأزرار ، (مثل الأزرار : "تنش - ديم"، "سويتش - ديم"، "بوش - ديم"، "دايركت - ديم"، "البح" ، في حدوث مشاكل تتعلق بعملية التزامن بين هذه الأزرار. وإن كان من الممكن تجنب مثل هذه المشاكل، وذلك عن طريق تزويد بعض الأجهزة الإضافية. ندعوكم للاتصال المباشر بالشركة، وذلك للحصول على أكبر قدر من المعلومات.

I Pilotare diversi prodotti DALI tramite pulsante (es: Touch-dim, Switch-dim, Push-dim, Direct-dim, etc.) potrebbe causare dei problemi di sincronizzazione tra gli stessi. È possibile ovviare a questo problema dotandosi di dispositivi aggiuntivi. Per maggiori informazioni vi invitiamo a contattarci direttamente.

GB Controlling different DALI products through buttons (e.g.: Touch-dim, Switch-dim, Push-dim, Direct-dim, etc.) may lead to product synchronisation problems. This problem can be overcome by using additional devices. For further information, please contact us directly.

E El mando de varios productos DALI por tecla (ej: Touch-dim, Switch-dim, Push-dim, Direct-dim, etc.) podría causar problemas de sincronización entre ellos. Es posible prevenir este problema utilizando dispositivos adicionales. Para más información, contacte directamente con nosotros.

## DALI

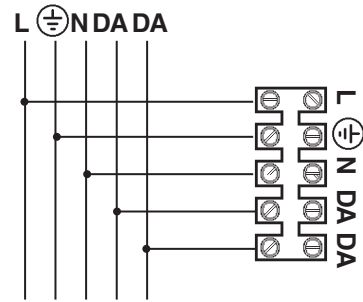

يمكن أن يتم تخفيض إضاءة الأجهزة ذات الكابلات الرقمية؛ وذلك عن طريق استخدام أجهزة الإمداد بالطاقة الكهربائية "دالي" (DALI)، أو عن طريق استخدام زر يكون مفتوحًا في وضعه الطبيعي (N.O)؛ حيث يتم التوصيل كما هو مبين في المخطط.

I I dispositivi con cablaggio digitale possono essere dimmerati con dispositivi DALI o con pulsante normalmente aperto (N.O.) da collegare come da schema.

GB Devices with digital control gear may be dimmed using DALI devices or a normally-open button (N.O.) to be connected as shown in the diagram.

E Los dispositivos con cableado digital pueden regularse con dispositivos DALI o con un interruptor de botón normalmente abierto (N.O.) que se conecta según ilustrado en el esquema.

## SWITCH DIM / TOUCH DIM







75/78

OK  
 نعم  
 أخضر  
 VERDE  
 GREEN  
 VERDE



طقة  
 CLICK!

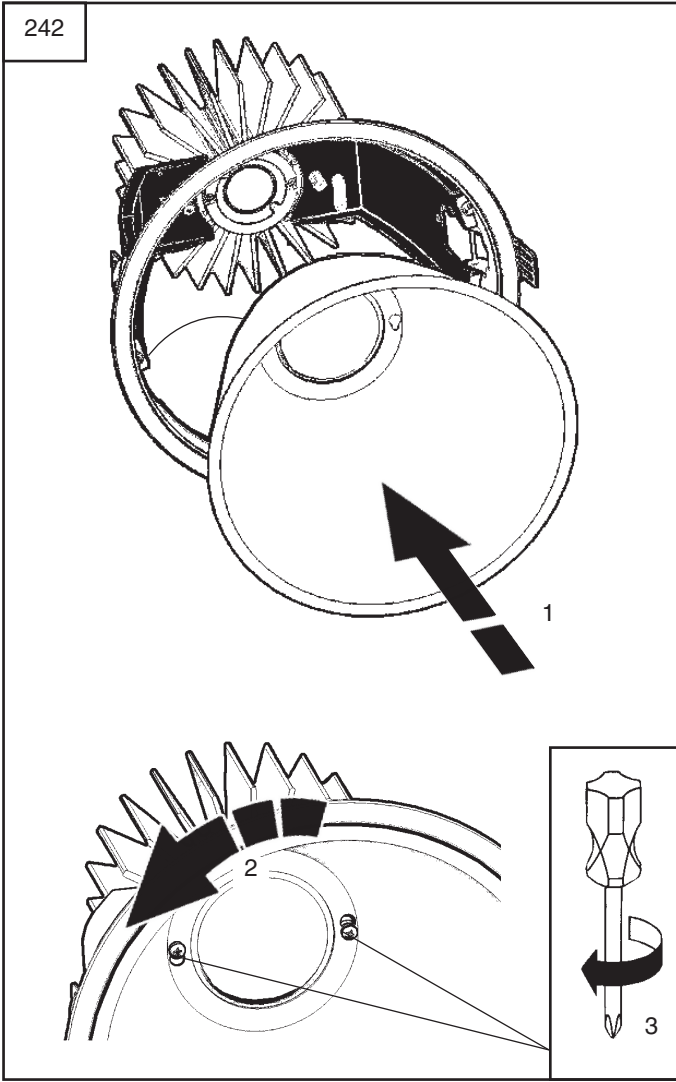

## استبدال الضوء LED

SOSTITUZIONE DEL LED  
REPLACING THE LED  
REEMPLAZO DEL LED

### تنبيه: لاستبدال الضوء LED اتصل بشركة iGuzzini.

I N.B.: Per la sostituzione del LED contattare l'azienda iGuzzini.  
GB N.B.: For information on LED replacement please contact iGuzzini.  
E NOTA: Para sustituir el LED llame a la empresa iGuzzini.

الصفحة	DALI شحنة / DALI حمل	DALI عناوين
ART.	CARICO DALI / DALI LOAD CHARGE DALI CARGA DALI	INDIRIZZI DALI DALI ADDRESSES DIRECCIONES DALI
	1	1

1.154.119.05 IS09154/07	<b>iQuzini</b>	fattore di potenza power factor facteur de puissance Leistungsfaktor vermogensfactor factor de potencia effektfaktor effektfaktor effektfaktor фактор мощности 功率因数	corrente assorbita absorbed current courant absorbé Stromaufnahme stroomopname corriente absorbida absorberet strøm absorbert strøm tillförd ström поглощаемая мощность 电源电流
ART.	λ	A	A
MV40-MV41-MV78-MV79 -P586	>0,9	0,042	
MV42-MV43-MV80-MV81-P587	0,9	0,044	
MV44-MV45-MV82-MV83-P588	>0,9	0,048	
MV46-MV47-MV84-MV85-P589	>0,9	0,050	
MV48-MV49-MV86-MV87-N121 -P507	>0,95	0,051	
MV50-MV51-MV88-MV89-N122 -P508	>0,95	0,053	
MV52-MV53-MV90-MV91-N123 -P509	>0,9	0,054	
MV54-MV55-MV92-MV93-N124	>0,9	0,056	
MV56-MV57-MV94-MV95-N125 -P510 Q959 - Q960 - Q962 - Q963 - Q978 - Q961	>0,9	0,064	
MV58-MV59-MV96-MV97-N111-N126 -P511	>0,95	0,068	
"N214-N215- N229-N230-N239-N244 -P512 MV68-MV69-N006-N007-N116-N131	>0,9	0,112	
MV60-MV61-MV98-MV99-N112-N127 -P513	>0,95	0,069	
"N216-N217-N231-N232-N240-N245 -P514 MV70-MV71-N008-N009-N117-N132	>0,9	0,112	
MV62-MV63-N000-N001-N113-N128 -P515	>0,95	0,068	
"N218-N219-N233-N234-N241-N246 -P516 MV72-MV73-N010-N011-N118-N133	>0,95	0,107	
MV64-MV65-N002-N003-N114-N129	>0,95	0,069	
"N220-N221-N235-N236-N242-N247 MV74-MV75-N012-N013-N119-N134	>0,95	0,112	
MV66-MV67-N004-N005-N115-N130 -P517 Q966 - Q968 - Q970 - Q972 - Q979 - Q981 - Q964	>0,95	0,086	
N222-N223-N237-N238-N243-N248 -P518 Q967 - Q969 - Q971 - Q973 - Q980 - Q982 - Q965	>0,95	0,14	
MV76-MV77-N014-N015-N120-N135 Q974 - Q975 - Q976 - Q977 - Q983 - Q984	>0,95	0,134	
N224-MM97-MN01-P519	>0,95	0,161	
N225-MM98-MN02 -P520	>0,95	0,165	
N226-MM99-MN03 -P521	>0,95	0,159	
N227-MN00-MN04	>0,95	0,165	
N228-N016-N136 -P522	>0,95	0,203	
N017-N018	>0,95	0,252	
N019-N020	>0,95	0,264	
N021-N022	>0,95	0,252	
N023-N024	>0,95	0,264	
P523 - P524 - P525	>0,95	0,109	
P526- P527- P528	>0,95	0,134	
P529 - P530 -P531	>0,95	0,193	
M636 - P532 - P533	>0,95	0,263	
Q262	>0,9	0,096	
Q263	>0,9	0,158	
Q264	>0,9	0,13	

1.154.119.05 IS09154/07	<b>iQuzini</b>	fattore di potenza power factor facteur de puissance Leistungsfaktor vermogensfactor factor de potencia effektfaktor effektfaktor effektfaktor фактор мощности 功率因数	corrente assorbita absorbed current courant absorbé Stromaufnahme stroomopname corriente absorbida absorberet strøm absorbert strøm tillförd ström поглощаемая мощность 电源电流
ART.	λ	A	A
MV40-MV41-MV78-MV79 -P586	>0,9	0,042	
MV42-MV43-MV80-MV81-P587	0,9	0,044	
MV44-MV45-MV82-MV83-P588	>0,9	0,048	
MV46-MV47-MV84-MV85-P589	>0,9	0,050	
MV48-MV49-MV86-MV87-N121 -P507	>0,95	0,051	
MV50-MV51-MV88-MV89-N122 -P508	>0,95	0,053	
MV52-MV53-MV90-MV91-N123 -P509	>0,9	0,054	
MV54-MV55-MV92-MV93-N124	>0,9	0,056	
MV56-MV57-MV94-MV95-N125 -P510 Q959 - Q960 - Q962 - Q963 - Q978 - Q961	>0,9	0,064	
MV58-MV59-MV96-MV97-N111-N126 -P511	>0,95	0,068	
"N214-N215- N229-N230-N239-N244 -P512 MV68-MV69-N006-N007-N116-N131	>0,9	0,112	
MV60-MV61-MV98-MV99-N112-N127 -P513	>0,95	0,069	
"N216-N217-N231-N232-N240-N245 -P514 MV70-MV71-N008-N009-N117-N132	>0,9	0,112	
MV62-MV63-N000-N001-N113-N128 -P515	>0,95	0,068	
"N218-N219-N233-N234-N241-N246 -P516 MV72-MV73-N010-N011-N118-N133	>0,95	0,107	
MV64-MV65-N002-N003-N114-N129	>0,95	0,069	
"N220-N221-N235-N236-N242-N247 MV74-MV75-N012-N013-N119-N134	>0,95	0,112	
MV66-MV67-N004-N005-N115-N130 -P517 Q966 - Q968 - Q970 - Q972 - Q979 - Q981 - Q964	>0,95	0,086	
N222-N223-N237-N238-N243-N248 -P518 Q967 - Q969 - Q971 - Q973 - Q980 - Q982 - Q965	>0,95	0,14	
MV76-MV77-N014-N015-N120-N135 Q974 - Q975 - Q976 - Q977 - Q983 - Q984	>0,95	0,134	
N224-MM97-MN01-P519	>0,95	0,161	
N225-MM98-MN02 -P520	>0,95	0,165	
N226-MM99-MN03 -P521	>0,95	0,159	
N227-MN00-MN04	>0,95	0,165	
N228-N016-N136 -P522	>0,95	0,203	
N017-N018	>0,95	0,252	
N019-N020	>0,95	0,264	
N021-N022	>0,95	0,252	
N023-N024	>0,95	0,264	
P523 - P524 - P525	>0,95	0,109	
P526- P527- P528	>0,95	0,134	
P529 - P530 -P531	>0,95	0,193	
M636 - P532 - P533	>0,95	0,263	
Q262	>0,9	0,096	
Q263	>0,9	0,158	
Q264	>0,9	0,13	

1.154.119.05 IS09154/07	<b>iQuzini</b>	fattore di potenza power factor facteur de puissance Leistungsfaktor vermogensfactor factor de potencia effektfaktor effektfaktor effektfaktor фактор мощности 功率因数	corrente assorbita absorbed current courant absorbé Stromaufnahme stroomopname corriente absorbida absorberet strøm absorbert strøm tillförd ström поглощаемая мощность 电源电流
ART.	λ	A	A
MV40-MV41-MV78-MV79 -P586	>0,9	0,042	
MV42-MV43-MV80-MV81-P587	0,9	0,044	
MV44-MV45-MV82-MV83-P588	>0,9	0,048	
MV46-MV47-MV84-MV85-P589	>0,9	0,050	
MV48-MV49-MV86-MV87-N121 -P507	>0,95	0,051	
MV50-MV51-MV88-MV89-N122 -P508	>0,95	0,053	
MV52-MV53-MV90-MV91-N123 -P509	>0,9	0,054	
MV54-MV55-MV92-MV93-N124	>0,9	0,056	
MV56-MV57-MV94-MV95-N125 -P510 Q959 - Q960 - Q962 - Q963 - Q978 - Q961	>0,9	0,064	
MV58-MV59-MV96-MV97-N111-N126 -P511	>0,95	0,068	
"N214-N215- N229-N230-N239-N244 -P512 MV68-MV69-N006-N007-N116-N131	>0,9	0,112	
MV60-MV61-MV98-MV99-N112-N127 -P513	>0,95	0,069	
"N216-N217-N231-N232-N240-N245 -P514 MV70-MV71-N008-N009-N117-N132	>0,9	0,112	
MV62-MV63-N000-N001-N113-N128 -P515	>0,95	0,068	
"N218-N219-N233-N234-N241-N246 -P516 MV72-MV73-N010-N011-N118-N133	>0,95	0,107	
MV64-MV65-N002-N003-N114-N129	>0,95	0,069	
"N220-N221-N235-N236-N242-N247 MV74-MV75-N012-N013-N119-N134	>0,95	0,112	
MV66-MV67-N004-N005-N115-N130 -P517 Q966 - Q968 - Q970 - Q972 - Q979 - Q981 - Q964	>0,95	0,086	
N222-N223-N237-N238-N243-N248 -P518 Q967 - Q969 - Q971 - Q973 - Q980 - Q982 - Q965	>0,95	0,14	
MV76-MV77-N014-N015-N120-N135 Q974 - Q975 - Q976 - Q977 - Q983 - Q984	>0,95	0,134	
N224-MM97-MN01-P519	>0,95	0,161	
N225-MM98-MN02 -P520	>0,95	0,165	
N226-MM99-MN03 -P521	>0,95	0,159	
N227-MN00-MN04	>0,95	0,165	
N228-N016-N136 -P522	>0,95	0,203	
N017-N018	>0,95	0,252	
N019-N020	>0,95	0,264	
N021-N022	>0,95	0,252	
N023-N024	>0,95	0,264	
P523 - P524 - P525	>0,95	0,109	
P526- P527- P528	>0,95	0,134	
P529 - P530 -P531	>0,95	0,193	
M636 - P532 - P533	>0,95	0,263	
Q262	>0,9	0,096	
Q263	>0,9	0,158	
Q264	>0,9	0,13	

1.154.544.00

IS00766/05

**SOSTITUZIONE DEL LED**  
**REPLACING THE LED**  
**REPLACEMENT DE LA LED**  
**AUSTAUSCHEN DER LED**  
**VERVANGEN VAN DE LED**  
**REEMPLAZO DEL LED**  
**UDSKIFTNING AF LYSDIODE**  
**BYTE AV LYSDIOD**  
**UTSKIFTING AV DEN LYSEMITTERENDE DIODEN**  
**ЗАМЕНА СИДа**  
**发光二极管替换**

**I N.B.:** Per la sostituzione del LED contattare l'azienda iGuzzini.

**GB N.B.:** For information on LED replacement please contact iGuzzini.

**F N.B.:** Pour procéder au remplacement de la LED, adressez-vous à la société iGuzzini.

**D N.B.:** Bezüglich des Austausches der LED kontaktieren Sie bitte die Firma iGuzzini.

**NL N.B.:** Voor het vervangen van de LED neemt u contact op met het bedrijf iGuzzini.

**E NOTA:** Para sustituir el LED llame a la empresa iGuzzini.

**DK N.B.:** For udskiftning af lysdioden, skal man kontakte iGuzzini.

**N N.B.:** For informasjon om skifte av LED, vennligst ta kontakt med iGuzzini.

**S OBS!** För byte av lysdioden, kontakta företaget iGuzzini.

**RUS ПРИМЕЧАНИЕ:**Для замены СИДов обращайтесь в компанию iGuzzini.

**CN 注意:** 如需LED更换的信息, 请联系iGuzzini.

**I** Gruppo di rischio 1, secondo norma **EN 62471: 2008**  
**GB** Risk Group: 1, in compliance with Standard **EN 62471: 2008**  
**FR** Groupe de risque 1, suivant la norme **EN 62471 : 2008**  
**DE** Risikogruppe 1, gemäß Vorschrift **EN 62471: 2008**  
**NL** Risicogroep 1, volgens de norm **EN 62471: 2008**  
**E** Grupo de riesgo 1, según norma **EN 62471: 2008**  
**DK** Faregruppe 1 i henhold til standarden **EN 62471: 2008**  
**N** Risikogruppe 1, i henhold til forskriften **EN 62471: 2008**  
**S** Riskgrupp 1, enligt standard **EN 62471: 2008**  
**RUS** ГРУПП РИСК 1 В СООТВЕТСТВИИ СО **EN 62471: 2008**

**CN** 风险组:1  
灯具和灯具系统的光生物学安全性符合标准 **EN 62471: 2008**

**iGuzzini**

1.154.544.00

IS00766/05

**SOSTITUZIONE DEL LED**  
**REPLACING THE LED**  
**REPLACEMENT DE LA LED**  
**AUSTAUSCHEN DER LED**  
**VERVANGEN VAN DE LED**  
**REEMPLAZO DEL LED**  
**UDSKIFTNING AF LYSDIODE**  
**BYTE AV LYSDIOD**  
**UTSKIFTING AV DEN LYSEMITTERENDE DIODEN**  
**ЗАМЕНА СИДа**  
**发光二极管替换**

**I N.B.:** Per la sostituzione del LED contattare l'azienda iGuzzini.

**GB N.B.:** For information on LED replacement please contact iGuzzini.

**F N.B.:** Pour procéder au remplacement de la LED, adressez-vous à la société iGuzzini.

**D N.B.:** Bezüglich des Austausches der LED kontaktieren Sie bitte die Firma iGuzzini.

**NL N.B.:** Voor het vervangen van de LED neemt u contact op met het bedrijf iGuzzini.

**E NOTA:** Para sustituir el LED llame a la empresa iGuzzini.

**DK N.B.:** For udskiftning af lysdioden, skal man kontakte iGuzzini.

**N N.B.:** For informasjon om skifte av LED, vennligst ta kontakt med iGuzzini.

**S OBS!** För byte av lysdioden, kontakta företaget iGuzzini.

**RUS ПРИМЕЧАНИЕ:**Для замены СИДов обращайтесь в компанию iGuzzini.

**CN 注意:** 如需LED更换的信息, 请联系iGuzzini.

**I** Gruppo di rischio 1, secondo norma **EN 62471: 2008**  
**GB** Risk Group: 1, in compliance with Standard **EN 62471: 2008**  
**FR** Groupe de risque 1, suivant la norme **EN 62471 : 2008**  
**DE** Risikogruppe 1, gemäß Vorschrift **EN 62471: 2008**  
**NL** Risicogroep 1, volgens de norm **EN 62471: 2008**  
**E** Grupo de riesgo 1, según norma **EN 62471: 2008**  
**DK** Faregruppe 1 i henhold til standarden **EN 62471: 2008**  
**N** Risikogruppe 1, i henhold til forskriften **EN 62471: 2008**  
**S** Riskgrupp 1, enligt standard **EN 62471: 2008**  
**RUS** ГРУПП РИСК 1 В СООТВЕТСТВИИ СО **EN 62471: 2008**

**CN** 风险组:1  
灯具和灯具系统的光生物学安全性符合标准 **EN 62471: 2008**

**iGuzzini**

1.154.544.00

IS00766/05

**SOSTITUZIONE DEL LED**  
**REPLACING THE LED**  
**REPLACEMENT DE LA LED**  
**AUSTAUSCHEN DER LED**  
**VERVANGEN VAN DE LED**  
**REEMPLAZO DEL LED**  
**UDSKIFTNING AF LYSDIODE**  
**BYTE AV LYSDIOD**  
**UTSKIFTING AV DEN LYSEMITTERENDE DIODEN**  
**ЗАМЕНА СИДа**  
**发光二极管替换**

**I N.B.:** Per la sostituzione del LED contattare l'azienda iGuzzini.

**GB N.B.:** For information on LED replacement please contact iGuzzini.

**F N.B.:** Pour procéder au remplacement de la LED, adressez-vous à la société iGuzzini.

**D N.B.:** Bezüglich des Austausches der LED kontaktieren Sie bitte die Firma iGuzzini.

**NL N.B.:** Voor het vervangen van de LED neemt u contact op met het bedrijf iGuzzini.

**E NOTA:** Para sustituir el LED llame a la empresa iGuzzini.

**DK N.B.:** For udskiftning af lysdioden, skal man kontakte iGuzzini.

**N N.B.:** For informasjon om skifte av LED, vennligst ta kontakt med iGuzzini.

**S OBS!** För byte av lysdioden, kontakta företaget iGuzzini.

**RUS ПРИМЕЧАНИЕ:**Для замены СИДов обращайтесь в компанию iGuzzini.

**CN 注意:** 如需LED更换的信息, 请联系iGuzzini.

**I** Gruppo di rischio 1, secondo norma **EN 62471: 2008**  
**GB** Risk Group: 1, in compliance with Standard **EN 62471: 2008**  
**FR** Groupe de risque 1, suivant la norme **EN 62471 : 2008**  
**DE** Risikogruppe 1, gemäß Vorschrift **EN 62471: 2008**  
**NL** Risicogroep 1, volgens de norm **EN 62471: 2008**  
**E** Grupo de riesgo 1, según norma **EN 62471: 2008**  
**DK** Faregruppe 1 i henhold til standarden **EN 62471: 2008**  
**N** Risikogruppe 1, i henhold til forskriften **EN 62471: 2008**  
**S** Riskgrupp 1, enligt standard **EN 62471: 2008**  
**RUS** ГРУПП РИСК 1 В СООТВЕТСТВИИ СО **EN 62471: 2008**

**CN** 风险组:1  
灯具和灯具系统的光生物学安全性符合标准 **EN 62471: 2008**

**iGuzzini**



## ONLY FOR DALI PRODUCT

1.154.599.01  
IS03599/03

# iGuzzini

- I** **ATTENZIONE:** con questo errore di collegamento il prodotto rischia di bloccarsi (FIG. 1).  
Per ripristinare, premere il pulsante 5 volte in 3 secondi come in FIG. 2, dopo che il difetto è stato rimosso.
- GB** **WARNING:** with this connection error the product risks to get blocked (FIG. 1).  
To restore, press the button 5 times in 3 seconds as shown in FIG. 2 after removing the defect.
- F** **ATTENTION :** cette erreur de raccordement risque de bloquer le produit (FIG. 1).  
Pour rétablir son fonctionnement, appuyer sur le bouton 5 fois de suite pendant 3 secondes comme illustré FIG. 2, après avoir supprimé le défaut.
- D** **ACHTUNG:** Bei diesem Anschlussfehler kann sich das Produkt blockieren (ABB. 1).  
Zum Zurücksetzen drücken Sie die Taste 5 Mal innerhalb von 3 Sekunden wie in ABB. 2 gezeigt, nachdem der Fehler behoben wurde.
- NL** **OPGELET:** met deze aansluitingsstoring riskeert u dat het product blokkeert. (AFB. 1).  
Om dit te herstellen moet u 5 keer in 3 seconden op de toets drukken, zoals aangegeven in AFB. 2, nadat de storing is opgelost.
- E** **ATENCIÓN:** con este error de conexión existe un riesgo de bloqueo del producto (FIG. 1).  
Para restablecer, oprimir el pulsador 5 veces en 3 segundos según ilustrado en la FIG. 2, después de eliminar el defecto.
- N** **ADVARSSEL:** med denne koblingsfeilen risikerer produktet å blokkeres (FIG. 1).  
For å gjenopprette, trykk på knappen 5 ganger i løpet av 3 sekunder, som angitt i FIG. 2, etter at feilen er fjernet.  
**PAS PÅ:** Ved den type feil i forbindelsen kan man risikere, at produktet låses fast (FIG. 1).
- DK** For at genoprette funktionen skal man trykke knappen ind 5 gange i 3 sekunder, som vist i FIG. 2, efter at fejlen er blevet udbedret.
- S** **OBSERVERA!** Med detta fel finns det risk för att produkten blockeras (FIG. 1).  
För att återställa efter att defekten har åtgärdats, tryck ned knappen 5 gånger i 3 sekunder som i FIG. 2.
- RUS** **ВНИМАНИЕ:** при наличии этой ошибки соединения продукт может заблокироваться (PVC. 1).  
Для восстановления нажмите на кнопку 5 раз за 3 секунды, как указано на PVC. 2, после того как был устранен дефект.
- CN** 注意：出现这种故障时，灯具可能停止运行（1号图表）。  
要重新启动，排除故障之后，请按照2号图表按按钮五次，每次三秒钟。

FIG. 1  
FIG. 1  
FIG. 1  
ABB. 1  
AFB. 1  
FIG. 1  
FIG. 1  
FIG. 1  
FIG. 1  
FIG. 1  
PVC.1  
1号图表



NO  
NO  
NON  
NEIN  
NEE  
NO  
NEI  
NEJ  
NEJ  
HET  
禁止

FIG. 2  
FIG. 2  
ABB. 2  
AFB. 2  
FIG. 2  
FIG. 2  
FIG. 2  
FIG. 2  
PVC.2  
2号图表

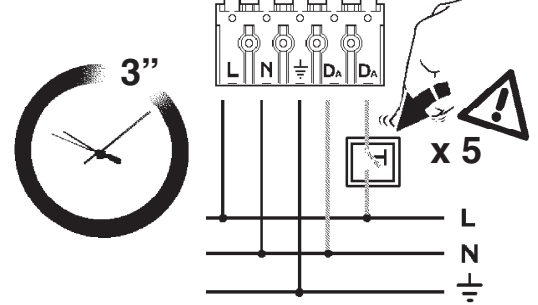

L  
N  
PE  
禁止

## ONLY FOR DALI PRODUCT

1.154.599.01  
IS03599/03

# iGuzzini

- I** **ATTENZIONE:** con questo errore di collegamento il prodotto rischia di bloccarsi (FIG. 1).  
Per ripristinare, premere il pulsante 5 volte in 3 secondi come in FIG. 2, dopo che il difetto è stato rimosso.
- GB** **WARNING:** with this connection error the product risks to get blocked (FIG. 1).  
To restore, press the button 5 times in 3 seconds as shown in FIG. 2 after removing the defect.
- F** **ATTENTION :** cette erreur de raccordement risque de bloquer le produit (FIG. 1).  
Pour rétablir son fonctionnement, appuyer sur le bouton 5 fois de suite pendant 3 secondes comme illustré FIG. 2, après avoir supprimé le défaut.
- D** **ACHTUNG:** Bei diesem Anschlussfehler kann sich das Produkt blockieren (ABB. 1).  
Zum Zurücksetzen drücken Sie die Taste 5 Mal innerhalb von 3 Sekunden wie in ABB. 2 gezeigt, nachdem der Fehler behoben wurde.
- NL** **OPGELET:** met deze aansluitingsstoring riskeert u dat het product blokkeert. (AFB. 1).  
Om dit te herstellen moet u 5 keer in 3 seconden op de toets drukken, zoals aangegeven in AFB. 2, nadat de storing is opgelost.
- E** **ATENCIÓN:** con este error de conexión existe un riesgo de bloqueo del producto (FIG. 1).  
Para restablecer, oprimir el pulsador 5 veces en 3 segundos según ilustrado en la FIG. 2, después de eliminar el defecto.
- N** **ADVARSSEL:** med denne koblingsfeilen risikerer produktet å blokkeres (FIG. 1).  
For å gjenopprette, trykk på knappen 5 ganger i løpet av 3 sekunder, som angitt i FIG. 2, etter at feilen er fjernet.  
**PAS PÅ:** Ved den type feil i forbindelsen kan man risikere, at produktet låses fast (FIG. 1).
- DK** For at genoprette funktionen skal man trykke knappen ind 5 gange i 3 sekunder, som vist i FIG. 2, efter at fejlen er blevet udbedret.
- S** **OBSERVERA!** Med detta fel finns det risk för att produkten blockeras (FIG. 1).  
För att återställa efter att defekten har åtgärdats, tryck ned knappen 5 gånger i 3 sekunder som i FIG. 2.
- RUS** **ВНИМАНИЕ:** при наличии этой ошибки соединения продукт может заблокироваться (PVC. 1).  
Для восстановления нажмите на кнопку 5 раз за 3 секунды, как указано на PVC. 2, после того как был устранен дефект.
- CN** 注意：出现这种故障时，灯具可能停止运行（1号图表）。  
要重新启动，排除故障之后，请按照2号图表按按钮五次，每次三秒钟。

FIG. 1  
FIG. 1  
FIG. 1  
ABB. 1  
AFB. 1  
FIG. 1  
FIG. 1  
FIG. 1  
FIG. 1  
FIG. 1  
PVC.1  
1号图表

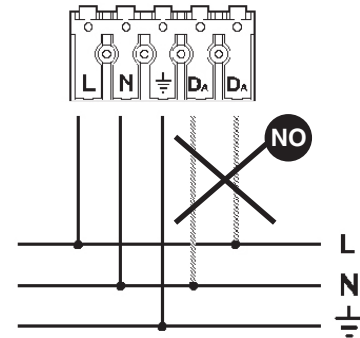

NO  
NO  
NON  
NEIN  
NEE  
NO  
NEI  
NEJ  
NEJ  
HET  
禁止

FIG. 2  
FIG. 2  
ABB. 2  
AFB. 2  
FIG. 2  
FIG. 2  
FIG. 2  
FIG. 2  
PVC.2  
2号图表

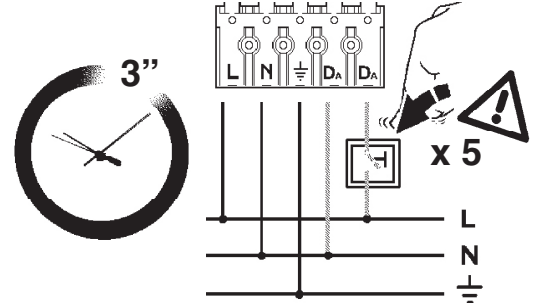

L  
N  
PE  
禁止

## ONLY FOR DALI PRODUCT

1.154.599.01  
IS03599/03

# iGuzzini

- I** **ATTENZIONE:** con questo errore di collegamento il prodotto rischia di bloccarsi (FIG. 1).  
Per ripristinare, premere il pulsante 5 volte in 3 secondi come in FIG. 2, dopo che il difetto è stato rimosso.
- GB** **WARNING:** with this connection error the product risks to get blocked (FIG. 1).  
To restore, press the button 5 times in 3 seconds as shown in FIG. 2 after removing the defect.
- F** **ATTENTION :** cette erreur de raccordement risque de bloquer le produit (FIG. 1).  
Pour rétablir son fonctionnement, appuyer sur le bouton 5 fois de suite pendant 3 secondes comme illustré FIG. 2, après avoir supprimé le défaut.
- D** **ACHTUNG:** Bei diesem Anschlussfehler kann sich das Produkt blockieren (ABB. 1).  
Zum Zurücksetzen drücken Sie die Taste 5 Mal innerhalb von 3 Sekunden wie in ABB. 2 gezeigt, nachdem der Fehler behoben wurde.
- NL** **OPGELET:** met deze aansluitingsstoring riskeert u dat het product blokkeert. (AFB. 1).  
Om dit te herstellen moet u 5 keer in 3 seconden op de toets drukken, zoals aangegeven in AFB. 2, nadat de storing is opgelost.
- E** **ATENCIÓN:** con este error de conexión existe un riesgo de bloqueo del producto (FIG. 1).  
Para restablecer, oprimir el pulsador 5 veces en 3 segundos según ilustrado en la FIG. 2, después de eliminar el defecto.
- N** **ADVARSSEL:** med denne koblingsfeilen risikerer produktet å blokkeres (FIG. 1).  
For å gjenopprette, trykk på knappen 5 ganger i løpet av 3 sekunder, som angitt i FIG. 2, etter at feilen er fjernet.  
**PAS PÅ:** Ved den type feil i forbindelsen kan man risikere, at produktet låses fast (FIG. 1).
- DK** For at genoprette funktionen skal man trykke knappen ind 5 gange i 3 sekunder, som vist i FIG. 2, efter at fejlen er blevet udbedret.
- S** **OBSERVERA!** Med detta fel finns det risk för att produkten blockeras (FIG. 1).  
För att återställa efter att defekten har åtgärdats, tryck ned knappen 5 gånger i 3 sekunder som i FIG. 2.
- RUS** **ВНИМАНИЕ:** при наличии этой ошибки соединения продукт может заблокироваться (PVC. 1).  
Для восстановления нажмите на кнопку 5 раз за 3 секунды, как указано на PVC. 2, после того как был устранен дефект.
- CN** 注意：出现这种故障时，灯具可能停止运行（1号图表）。  
要重新启动，排除故障之后，请按照2号图表按按钮五次，每次三秒钟。

FIG. 1  
FIG. 1  
FIG. 1  
ABB. 1  
AFB. 1  
FIG. 1  
FIG. 1  
FIG. 1  
FIG. 1  
FIG. 1  
PVC.1  
1号图表

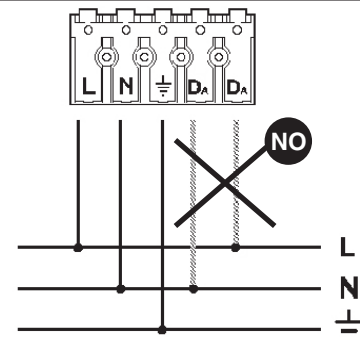

NO  
NO  
NON  
NEIN  
NEE  
NO  
NEI  
NEJ  
NEJ  
HET  
禁止

FIG. 2  
FIG. 2  
ABB. 2  
AFB. 2  
FIG. 2  
FIG. 2  
FIG. 2  
FIG. 2  
PVC.2  
2号图表

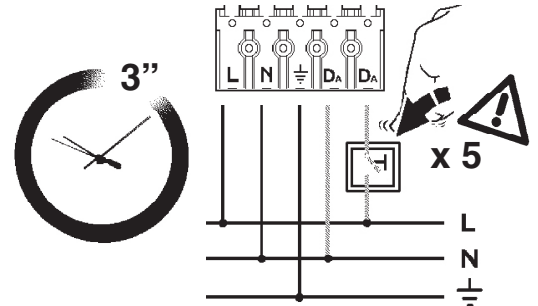

L  
N  
PE  
禁止

2.509.216.00  
IS05718/01

استبدال الضوء LED  
SOSTITUZIONE DEL LED  
REPLACING THE LED  
REEMPLAZO DEL LED

تنبیه: لاستبدال الضوء LED اتصل بشركة iGuzzini . عر

I N.B.: Per la sostituzione del LED contattare l'azienda iGuzzini.

GB N.B.: For information on LED replacement please contact iGuzzini.

E NOTA: Para sustituir el LED llame a la empresa iGuzzini.

فئة الخطر 1 . حسب مقاييس EN 62471: 2008 . عر

I Gruppo di rischio 1, secondo norma EN 62471: 2008

GB Risk Group: 1, in compliance with Standard EN 62471: 2008

E Grupo de riesgo 1, según norma EN 62471: 2008

iGuzzini

2.509.216.00  
IS05718/01

استبدال الضوء LED  
SOSTITUZIONE DEL LED  
REPLACING THE LED  
REEMPLAZO DEL LED

تنبیه: لاستبدال الضوء LED اتصل بشركة iGuzzini . عر

I N.B.: Per la sostituzione del LED contattare l'azienda iGuzzini.

GB N.B.: For information on LED replacement please contact iGuzzini.

E NOTA: Para sustituir el LED llame a la empresa iGuzzini.

فئة الخطر 1 . حسب مقاييس EN 62471: 2008 . عر

I Gruppo di rischio 1, secondo norma EN 62471: 2008

GB Risk Group: 1, in compliance with Standard EN 62471: 2008

E Grupo de riesgo 1, según norma EN 62471: 2008

iGuzzini

2.509.216.00  
IS05718/01

استبدال الضوء LED  
SOSTITUZIONE DEL LED  
REPLACING THE LED  
REEMPLAZO DEL LED

تنبیه: لاستبدال الضوء LED اتصل بشركة iGuzzini . عر

I N.B.: Per la sostituzione del LED contattare l'azienda iGuzzini.

GB N.B.: For information on LED replacement please contact iGuzzini.

E NOTA: Para sustituir el LED llame a la empresa iGuzzini.

فئة الخطر 1 . حسب مقاييس EN 62471: 2008 . عر

I Gruppo di rischio 1, secondo norma EN 62471: 2008

GB Risk Group: 1, in compliance with Standard EN 62471: 2008

E Grupo de riesgo 1, según norma EN 62471: 2008

iGuzzini

2.509.216.00  
IS05718/01

استبدال الضوء LED  
SOSTITUZIONE DEL LED  
REPLACING THE LED  
REEMPLAZO DEL LED

تنبیه: لاستبدال الضوء LED اتصل بشركة iGuzzini . عر

I N.B.: Per la sostituzione del LED contattare l'azienda iGuzzini.

GB N.B.: For information on LED replacement please contact iGuzzini.

E NOTA: Para sustituir el LED llame a la empresa iGuzzini.

فئة الخطر 1 . حسب مقاييس EN 62471: 2008 . عر

I Gruppo di rischio 1, secondo norma EN 62471: 2008

GB Risk Group: 1, in compliance with Standard EN 62471: 2008

E Grupo de riesgo 1, según norma EN 62471: 2008

iGuzzini

2.509.216.00  
IS05718/01

استبدال الضوء LED  
SOSTITUZIONE DEL LED  
REPLACING THE LED  
REEMPLAZO DEL LED

تنبیه: لاستبدال الضوء LED اتصل بشركة iGuzzini . عر

I N.B.: Per la sostituzione del LED contattare l'azienda iGuzzini.

GB N.B.: For information on LED replacement please contact iGuzzini.

E NOTA: Para sustituir el LED llame a la empresa iGuzzini.

فئة الخطر 1 . حسب مقاييس EN 62471: 2008 . عر

I Gruppo di rischio 1, secondo norma EN 62471: 2008

GB Risk Group: 1, in compliance with Standard EN 62471: 2008

E Grupo de riesgo 1, según norma EN 62471: 2008

iGuzzini

## ONLY FOR DALI PRODUCT

2.509.296.01  
IS07392/01

# iGuzzini

الشكل 1  
FIG. 1



تنبيه: خطر حدوث عطل مع هذا الخطأ في التوصيل. (الشكل 1)  
لإعادة التنشيط، اضغط على الزر 5 مرات في 3 ثوان كما هو موضح في الشكل 2، بعد التأكد من تلاشي الخطأ.

I **ATTENZIONE:** con questo errore di collegamento il prodotto rischia di bloccarsi (FIG. 1).  
Per ripristinare, premere il pulsante 5 volte in 3 secondi come in FIG. 2, dopo che il difetto è stato rimosso.

GB **WARNING:** with this connection error the product risks to get blocked (FIG. 1).  
To restore, press the button 5 times in 3 seconds as shown in FIG. 2, after removing the defect.

E **ATENCIÓN:** con este error de conexión existe un riesgo de bloqueo del producto (FIG. 1).  
Pare restablecer, oprimir el pulsador 5 veces en 3 segundos según ilustrado en la FIG. 2, después de eliminar el defecto.

الشكل 2  
FIG. 2



## ONLY FOR DALI PRODUCT

2.509.296.01  
IS07392/01

# iGuzzini

الشكل 1  
FIG. 1



تنبيه: خطر حدوث عطل مع هذا الخطأ في التوصيل. (الشكل 1)  
لإعادة التنشيط، اضغط على الزر 5 مرات في 3 ثوان كما هو موضح في الشكل 2، بعد التأكد من تلاشي الخطأ.

I **ATTENZIONE:** con questo errore di collegamento il prodotto rischia di bloccarsi (FIG. 1).  
Per ripristinare, premere il pulsante 5 volte in 3 secondi come in FIG. 2, dopo che il difetto è stato rimosso.

GB **WARNING:** with this connection error the product risks to get blocked (FIG. 1).  
To restore, press the button 5 times in 3 seconds as shown in FIG. 2, after removing the defect.

E **ATENCIÓN:** con este error de conexión existe un riesgo de bloqueo del producto (FIG. 1).  
Pare restablecer, oprimir el pulsador 5 veces en 3 segundos según ilustrado en la FIG. 2, después de eliminar el defecto.

الشكل 2  
FIG. 2



## ONLY FOR DALI PRODUCT

2.509.296.01  
IS07392/01

# iGuzzini

الشكل 1  
FIG. 1

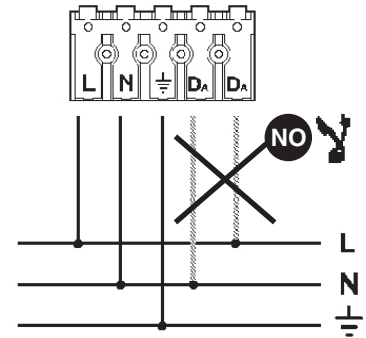

تنبيه: خطر حدوث عطل مع هذا الخطأ في التوصيل. (الشكل 1)  
لإعادة التنشيط، اضغط على الزر 5 مرات في 3 ثوان كما هو موضح في الشكل 2، بعد التأكد من تلاشي الخطأ.

I **ATTENZIONE:** con questo errore di collegamento il prodotto rischia di bloccarsi (FIG. 1).  
Per ripristinare, premere il pulsante 5 volte in 3 secondi come in FIG. 2, dopo che il difetto è stato rimosso.

GB **WARNING:** with this connection error the product risks to get blocked (FIG. 1).  
To restore, press the button 5 times in 3 seconds as shown in FIG. 2, after removing the defect.

E **ATENCIÓN:** con este error de conexión existe un riesgo de bloqueo del producto (FIG. 1).  
Pare restablecer, oprimir el pulsador 5 veces en 3 segundos según ilustrado en la FIG. 2, después de eliminar el defecto.

الشكل 2  
FIG. 2



- I Istruzioni per le operazioni di servizio per l'apparecchio di illuminazione**  
**GB Instructions on luminaire service operations**  
**F Instructions pour les opérations de service du luminaire**  
**D Wartungsanleitung für die Leuchte**  
**NL Instructies voor de onderhoudsoperaties op de verlichtingsarmatuur**  
**E Instrucciones para las operaciones de servicio del aparato de alumbrado**  
**DK Anvisninger i serviceindgreb på belysningsarmatur**  
**N Anvisninger for betjening av lysapparatet**  
**S Instruktioner för användning av belysningsanordningen**  
**RUS Инструкция по эксплуатации осветительного прибора**  
**CN 照明装置检修操作说明**

**Sostituire la lampada parzialmente esausta**  
 Replace the partly exhausted lamp  
 Remplacer la lampe partiellement épuisée  
 Die teilweise erschöpfte Lampe austauschen  
 Vervang de gedeeltelijk lege lamp  
 Sustituir la lámpara parzialmente agotada  
 Udskift den delvist udtjente pære  
 Skifte ut den delvis utbrente lyspæren  
 Byt ut den delvis förbrukade lampan  
 Замена частично отработанной лампочки  
 更换部分老化的灯泡



**Spegnimento**  
 Switch it off  
 Extinction  
 Ausschaltung  
 Uitschakeling  
 Apagado  
 Slukning  
 Slukking  
 Släckning  
 Выключение  
 关灯

**Interrompere l'alimentazione dell'apparecchio**  
 Cut the power supply to the luminaire  
 Couper l'alimentation du luminaire  
 Stromversorgung der Leuchte unterbrechen  
 Onderbreek de voeding van het apparaat  
 Interrumpir la alimentación del aparato  
 Afbryd armaturets strømforsyning  
 Avbryte strømtilførselen til apparatet  
 Koppla från anordningens strömförsörjning  
 Отключить электропитание прибора  
 中断装置供电



**Aprire l'apparecchio**  
 Open the fixture  
 Ouvrir le luminaire  
 Das Gerät öffnen  
 Open het apparaat  
 Abrir el aparato  
 Åbn armaturet  
 Åpne apparatet  
 Öppna anordningen  
 Раскрыть прибор  
 打开装置



**Rimuovere la lampada esausta**  
 Remove the exhausted lamp  
 Retirer la lampe épuisée  
 Die alte Lampe entnehmen  
 Verwijder de lege lamp  
 Quitar la lámpara agotada  
 Tag den udtjente pære ud  
 Fjerne den utbrente lyspæren  
 Ta bort den förbrukade lampan  
 Вынуть старую лампочку  
 取出老化的灯泡

**Portarla in un centro di riciclaggio**  
 Carry it to a recycling centre  
 La porter dans une déchetterie pour son recyclage  
 Ordnungsgemäß entsorgen  
 Breng de lamp naar een recyclingcentrum  
 Llevarla a un centro de reciclaje  
 Aflever den på en genbrugsstation  
 Lever den til en miljøstasjon  
 Lämna in den till en återvinningsanläggning  
 Сдать ее в пункт приема утильсырья  
 将其送往回收中心



**Inserire la nuova lampada**  
 Introduce the new lamp  
 Installer la lampe neuve  
 Die neue Lampe einsetzen  
 Doe de nieuwe lamp op zijn plek  
 Montar la nueva lámpara  
 Sæt den nye pære i  
 Sette i den nye pæren  
 Sätt i den nya lampan  
 Вставить новую лампочку  
 装入新灯泡

**Inserire la nuova lampada nel portalampana**  
 Fit the new lamp into the socket  
 Installer la nouvelle lampe dans le support de lampe  
 Die neue Lampe in den Sockel einsetzen  
 Doe de nieuwe lamp in de lamphouder  
 Montar la nueva lámpara en el portalampana  
 Sæt den nye pære i fatningen  
 Sette den nye pæren inn i lampeholderen  
 Sätt i den nya lampan i lamphållaren  
 Вставить новую лампочку в патрон  
 将新灯泡插入灯泡架中



**Riposizionare ottica**  
 Re-place the optic  
 Remettre l'optique à sa place  
 Die Optik wieder einsetzen  
 Doe de optiek weer op zijn plaats  
 Volver a montar la óptica  
 Sæt den optiske enhed på plads  
 Innstille linsen  
 Flytta om optiken  
 Отрегулировать линзы  
 重新定位光头



**Effettuare prova di funzionamento**  
 Perform operative test  
 Procéder à un essai de fonctionnement  
 Eine Funktionsprüfung durchführen  
 Controleer de correcte werking  
 Hacer una prueba de funcionamiento  
 Afprøv funktionen  
 Prøve om den fungerer  
 Utför funktionstest  
 Выполнить проверку исправности работы  
 执行功能测试



**I Istruzioni per la pulizia dell'apparecchio di illuminazione**  
**GB Instructions on luminaire cleaning operations**  
**F Instructions pour le nettoyage du luminaire**  
**D Anweisungen zur Reinigung der Leuchte**  
**NL Instructies voor de reiniging van de verlichtingsarmatuur**  
**E Instrucciones para limpiar el aparato de alumbrado**  
**DK Anvisninger i rengøring af belysningsarmaturet**  
**N Anvisninger for rengjøring av lysapparatet**  
**S Instruktioner för rengöring av belysningsanordningen**  
**RUS Инструкции по чистке осветительного прибора**  
**CN 照明装置清洁说明**

**Pulire l'apparecchio**  
**Clean the fixture**  
**Nettoyer le luminaire**  
**Das Gerät reinigen**  
**Reinig het apparaat**  
**Limpiar el aparato**  
**Rengør armaturet**  
**Rengjøre apparatet**  
**Rengör anordningen**  
**Чистка прибора**  
**清洁装置**



**Spegnimento**  
**Switch it off**  
**Extinction**  
**Ausschaltung**  
**Uitschakeling**  
**Apagado**  
**Slukning**  
**Slukking**  
**Släckning**  
**Выключение**  
**关灯**

**Interrompere l'alimentazione dell'apparecchio**  
**Cut the power supply to the luminaire**  
**Couper l'alimentation du luminaire**  
**Stromversorgung der Leuchte unterbrechen**  
**Onderbreek de voeding van het apparaat**  
**Interrumpir la alimentación del aparato**  
**Afbryd armaturets strømforsyning**  
**Avbryt strømtilførselen til apparatet**  
**Koppla från anordningens strömförsörjning**  
**Отключить электропитание прибора**  
**中断装置供电**



**Spolverare l'ottica esterna**  
**Remove dust from the external optic**  
**Dépoussiérer l'optique extérieure**  
**Die externe Optik abstauben**  
**Stof de externe optiek af**  
**Quitar el polvo de la óptica exterior**  
**Tør støvet af den udvendige optiske enhed**  
**Fjerne støv fra den eksterne lysenheden**  
**Damma av den yttre optiken**  
**Вытереть пыль с внешней стороны линз**  
**为外侧光头掸尘**



**Lavare l'ottica esterna**  
**Wash the external optic**  
**Laver l'optique extérieure**  
**Die externe Optik waschen**  
**Was de externe optiek**  
**Lavar la óptica exterior**  
**Vask den udvendige optiske enhed**  
**Vaske den eksterne lysenheden**  
**Rengör den yttre optiken**  
**Вымыть линзы с внешней стороны**  
**清洁外光头**



**Rimuovere l'ottica**  
**Remove the optic**  
**Retirer l'optique**  
**Die Optik abnehmen**  
**Verwijder de optiek**  
**Quitar la óptica**  
**Tag den optiske enhed af**  
**Fjerne lysenheden**  
**Ta bort optiken**  
**Снять линзы**  
**取下光头**



**Pulire la parte interna dell'apparecchio di illuminazione**  
**Clean the inside of the fixture**  
**Nettoyer l'intérieur du luminaire**  
**Die Innenseite der Leuchte reinigen**  
**Reinig de binnenzijde van de verlichtingsarmatuur**  
**Limpiar el interior del aparato de alumbrado**  
**Rengør belysningsarmaturets indvendige dele**  
**Rengjøre lysapparatet innvendig**  
**Rengör belysningsanordningen invändigt**  
**Протереть осветительный прибор изнутри**  
**清洁照明装置内部**



**Riposizionare ottica**  
**Re-place the optic**  
**Remettre l'optique à sa place**  
**Die Optik wieder einsetzen**  
**Doe de optiek weer op zijn plaats**  
**Volver a montar la óptica**  
**Sæt den optiske enhed på plads**  
**Innstille linsen**  
**Flytta om optiken**  
**Отрегулировать линзы**  
**重新定位光头**



**Effettuare prova di funzionamento**  
**Perform operative test**  
**Procéder à un essai de fonctionnement**  
**Eine Funktionsprüfung durchführen**  
**Controleer de correcte werking**  
**Hacer una prueba de funcionamiento**  
**Afprøv funktionen**  
**Prøve om den fungerer**  
**Utför funktionstest**  
**Выполнить проверку исправности работы**  
**执行功能测试**



- I** Istruzioni per il fine vita e lo smaltimento dei componenti  
**GB** Instructions on end-of-life and component disposal  
**F** Instructions pour la gestion des composants en fin de vie et leur mise au rebut  
**D** Anweisungen zur Entsorgung der Leuchtenkomponenten  
**NL** Instructies voor het verwijderen van de armatuur en het recyclen van de onderdelen  
**E** Instrucciones para el final de vida y la eliminación los componentes  
**DK** Anvisninger i udtjent armatur og bortskaffelse af komponenter  
**N** Anvisninger for endt levetid og avfallsbehandling av delene  
**S** Instruktioner vid bortskaffning och kassering av komponenter  
**RUS** Инструкции по утилизации прибора и его комплектующих по окончании его срока службы  
**CN** 寿命期结束与零件废弃处置说明

<p>Spegnimento Switch it off Extinction Ausschaltung Uitschakeling Apagado Slukning Slukking Släckning Выключение 关灯</p> <p>Interrompere l'alimentazione dell'apparecchio Cut the power supply to the luminaire Couper l'alimentation du luminaire Stromversorgung der Leuchte unterbrechen Onderbreek de voeding van het apparaat Interrompirla alimentación del aparato Afbryd armaturets strømforsyning Avbryt strømtilførselen til apparatet Koppla från anordningens strömförsörjning Отключить электропитание прибора 中断装置供电</p> 	<p>Rimuovere la/e lampada/e per la dismissione Remove the lamp(s) for decommissioning Retirer la(les) lampe(s) pour sa(leur) mise au rebut Die Lampe/n ordnungsgemäß entsorgen Verwijder de lamp(en) voor het recyclen Quitar la(s) lámpara(s) para el desecho Tag pæren/pærerne ud til bortskaffelse Fjerne lampen/-e som skal kastes Ta bort lampan/-orna för bortskaffningen Вынуть лампочку/и для утилизации прибора 取出需要丢弃的灯泡</p> 	<p>Rimuovere la batteria per la dismissione Remove the battery for decommissioning Retirer la batterie pour sa mise au rebut Die Batterie ordnungsgemäß entsorgen Verwijder de batterij voor het recyclen Quitar la batería para el desecho Tag batteriet ud til bortskaffelse Fjerne batteriet som skal kastes Ta bort batteriet för bortskaffningen Вынуть батарейку для утилизации прибора 取出需要丢弃的电池</p> 	<p>Rimuovere l'apparecchio per la dismissione Remove the fixture for decommissioning Enlever le luminaire pour sa mise au rebut Das Gerät ordnungsgemäß entsorgen Verwijder het apparaat voor het recyclen Quitar el aparato para el desecho Tag armaturet ud til bortskaffelse Fjerne apparatet som skal kastes Ta bort anordningen för bortskaffningen Снять прибор для утилизации 取出需要丢弃的装置</p> 
-----------------------------------------------------------------------------------------------------------------------------------------------------------------------------------------------------------------------------------------------------------------------------------------------------------------------------------------------------------------------------------------------------------------------------------------------------------------------------------------------------------------------------------------------------------------------------------------------------------------------------------------------------------------------------------------------------------	------------------------------------------------------------------------------------------------------------------------------------------------------------------------------------------------------------------------------------------------------------------------------------------------------------------------------------------------------------------------------------------------------------------------------------------------------------------------------------------------------------------------------------------------------------------	----------------------------------------------------------------------------------------------------------------------------------------------------------------------------------------------------------------------------------------------------------------------------------------------------------------------------------------------------------------------------------------------------------------------------------------------------------------------------------------------------------------------------------------	--------------------------------------------------------------------------------------------------------------------------------------------------------------------------------------------------------------------------------------------------------------------------------------------------------------------------------------------------------------------------------------------------------------------------------------------------------------------------------------------------------------------------------

<p>Inviare i materiali ad un centro di raccolta RAEE Send the materials to a WEEE collection centre Envoyer les matériaux dans une déchetterie DEEE Die Materialien in einem WEEE-Zentrum entsorgen Zend de materialen naar een recyclingscentrum voor de AEEA Enviar los materiales a un centro de recogida RAEE Afløver materialerne på et indsamlingscenter for elektronisk udstyr Sende materialene til en miljøstasjon for resirkulering av EE-avfall Skicka materialet till en RAEE uppsamlingscentral Сдать материалы в пункт приема утильсырья 将材料送往电气和电子垃圾回收中心</p> 			
--------------------------------------------------------------------------------------------------------------------------------------------------------------------------------------------------------------------------------------------------------------------------------------------------------------------------------------------------------------------------------------------------------------------------------------------------------------------------------------------------------------------------------------------------------------------------------------------------------------------------------------------------------------------------------------------------------------------	--	--	--