

TECNICA PRO

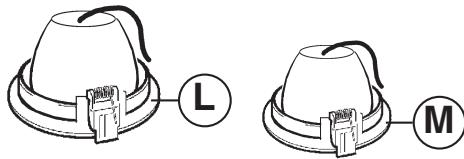

ATTENZIONE:

LA SICUREZZA DELL'APPARECCHIO E' GARANTITA SOLO CON L'USO APPROPRIATO DELLE SEGUENTI ISTRUZIONI; PERTANTO E' NECESSARIO CONSERVARLE.

WARNING:

THE SAFETY OF THIS FIXTURE IS GUARANTEED ONLY IF YOU COMPLY WITH THESE INSTRUCTIONS; REMEMBER TO CONSERVE IN A SAFE PLACE.

ATTENTION:

LA SECURITE DE L'APPAREIL N'EST GARANTIE QU'EN CAS D'UTILISATION CORRECTE DES INSTRUCTIONS SUIVANTES; IL FAUT PAR CONSEQUENT LES CONSERVER.

ACHTUNG:

DIE SICHERHEIT DES GERÄTES WIRD NUR DURCH SACHGEMÄSSE BEFOLGUNG NACHSTEHENDER ANWEISUNGEN GEWÄHRLEISTET; IHRE AUFBEWAHRUNG IST DESHALB SEHR WICHTIG.

OPGELET:

DE VEILIGHEID VAN DI ATOESTEL IS SLECHTS DAN GEGARANDEERD ALS INDIEN DE VOLGENDE INSTRUCTIES STRIKT WORDEN TOEGEPAST: DAAROM MOET MEN ZE OOK BEWAAREN.

ATENCIÓN:

LA SEGURIDAD DEL APARATO SE GARANTIZA SOLO CUMPLIENDO CUIDADOSAMENTE LAS SIGUIENTES INSTRUCCIONES; POR ELLO, ES NECESARIO CONSERVARLAS.

BEMÆRK:

SIKKERHEDEN VED BRUG AF ARMATURET KAN KUN GARANTERES, HVIS DISSE ANVISNINGER FØLGES; SØRG DERFOR FOR AT GEMME DEM.

ADVARSEL:

SIKKERHETEN TIL DETTE APPARATET GARANTERES KUN HVIS DU OVERHOLDER DISSE INSTRUKSJONENE; HUSK Å OPPBEVARE DEM PÅ ET TRYGT STED.

OBSERVERA!

UTRUSTNINGENS SÄKERHET KAN ENDAST GARANTERAS OM DESSA ANVISNINGAR RESPEKTERAS I DETALJ. SPARA DÄRFÖR DESSA ANVISNINGAR FÖR FRAMTIDA KONSULTATION.

ВНИМАНИЕ:

МЫ ГАРАНТИРУЕМ БЕЗОПАСНУЮ ЭКСПЛУАТАЦИЮ ИЗДЕЛИЯ ТОЛЬКО ПРИ СОБЛЮДЕНИИ СЛЕДУЮЩИХ ИНСТРУКЦИЙ; С ЭТОЙ ЦЕЛЬЮ НЕОБХОДИМО СОХРАНИТЬ ДАННУЮ БРОШЮРУ.

警告

为确保该装置安全，请遵守操作指示；并于安全场所放置。

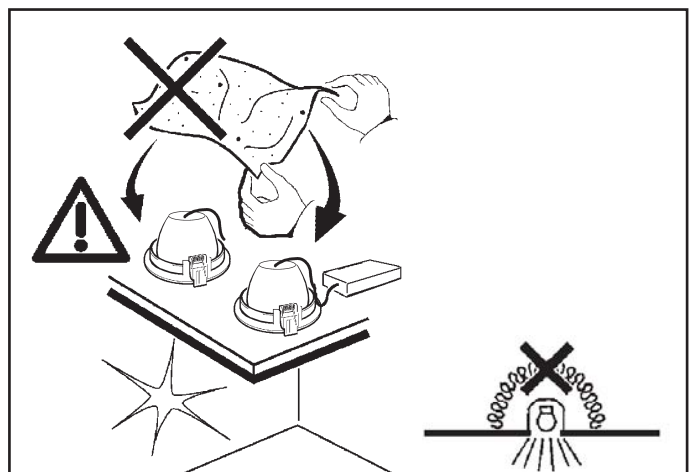
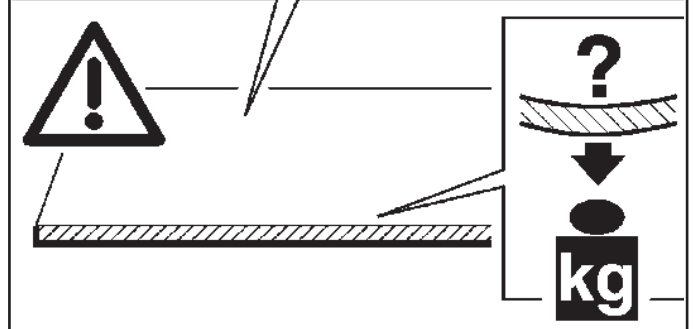
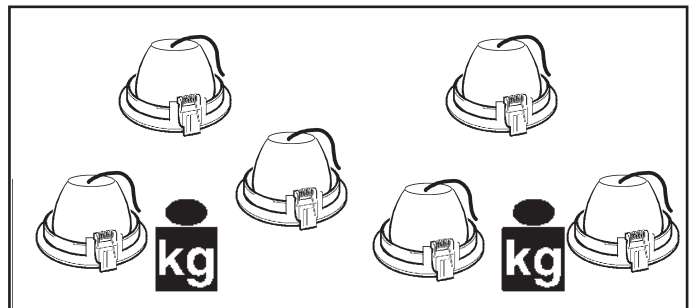
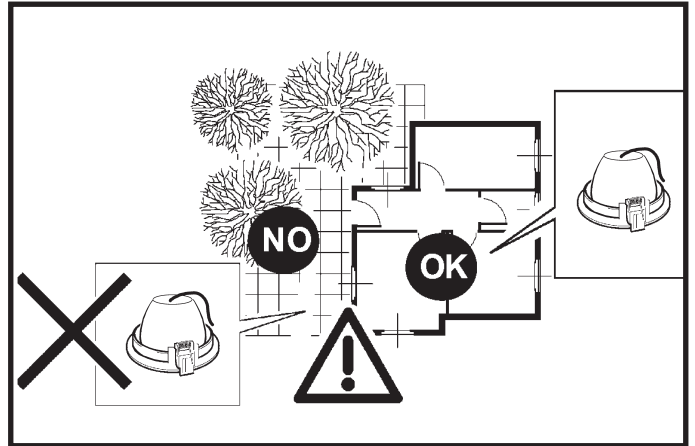

I L'apparecchio non deve, in alcuna circostanza, essere coperto con materiale isolante o similare.

GB The fixture must not be covered, under any circumstances, by insulating material or the like.

F L'appareil ne doit, en aucun cas, être couvert par un matériau isolant ou autre.

D Das Gerät darf auf keinen Fall mit Isoliermaterial oder ähnlichem bedeckt werden.

NL Het apparaat mag in geen geval bedekt worden met isoleringsmateriaal of dergelijke.

E El aparato no debe ser protegido con material aislante o parecido, por ninguna causa.

N Apparatet må aldri i noen som helst tilfeller dekkes med isolerende materiale eller lignende.

DK Apparatet må under ingen omstændigheder tildækkes med isolerende materiale eller lignende materiale.

S Utrustningen får inte under några omständigheter täckas över med isolerande material eller liknande.

RUS Установка этого прибора запрещается при использовании для его защиты или покрытия.

CN 装置在任何情況下都不能用絕緣材料或類似物覆蓋。

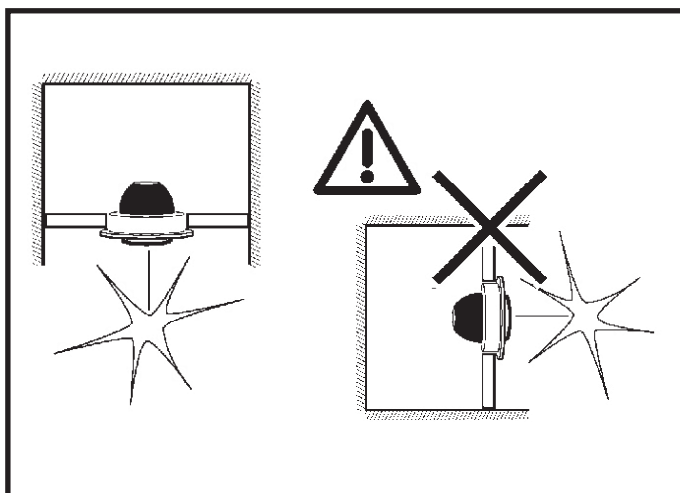
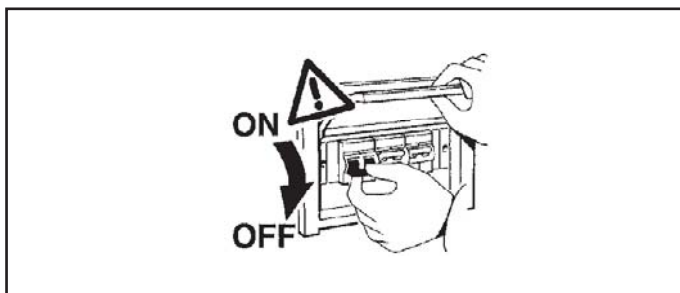

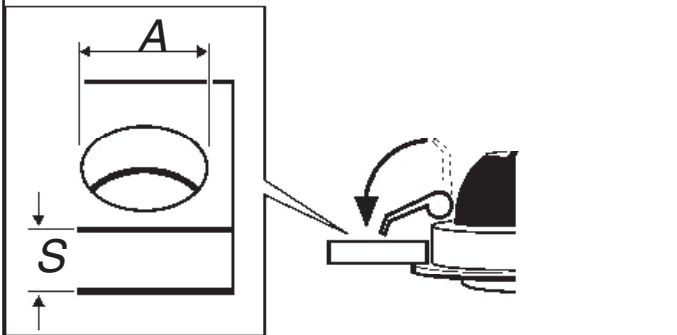
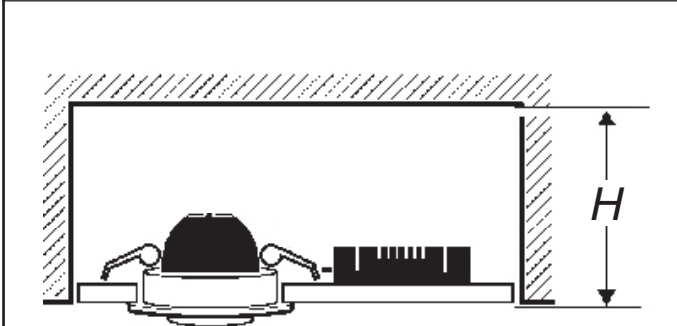
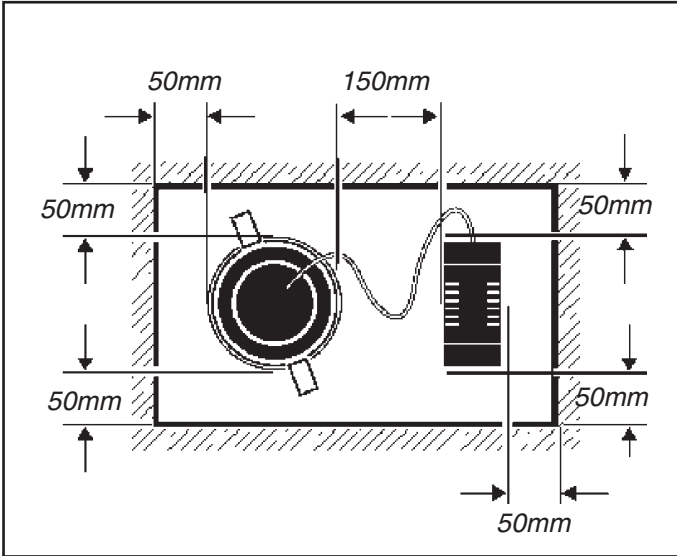
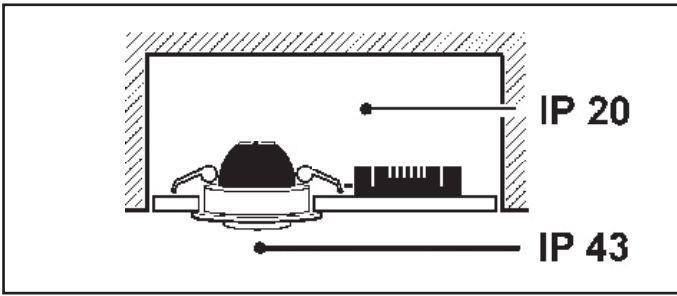

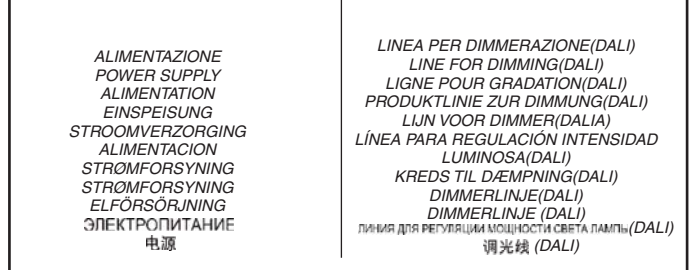
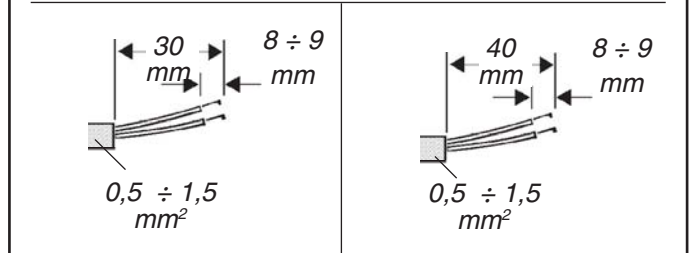
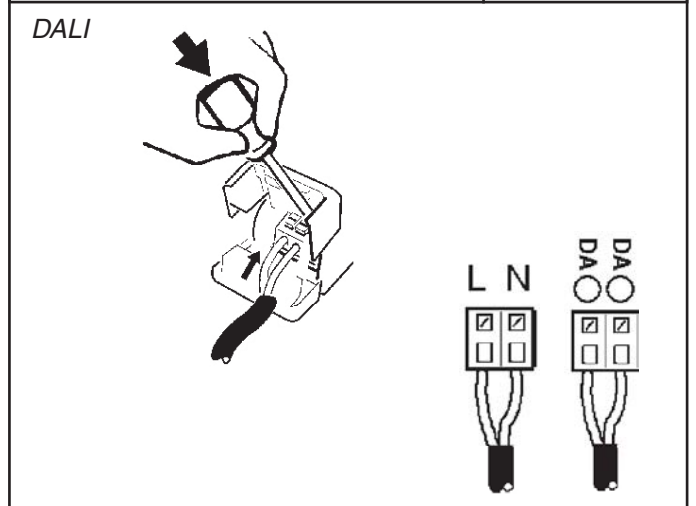
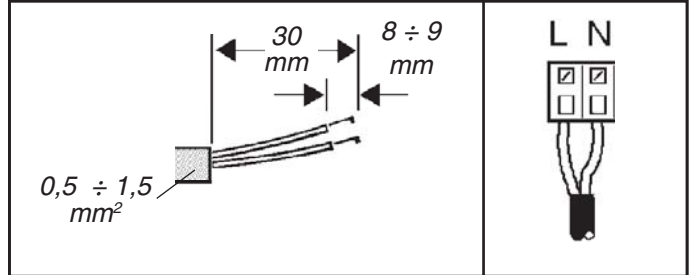
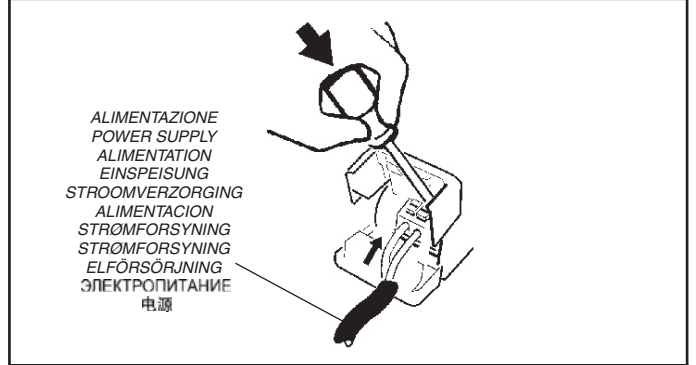
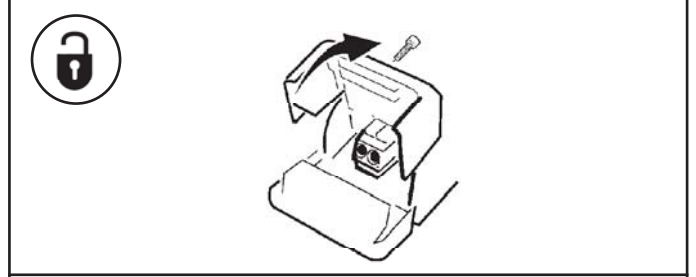
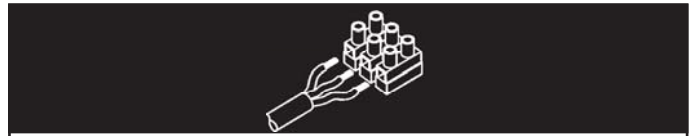

| ART. | A mm | S mm | H mm |
|--|------|--------|------|
| MK88 - MK89 - MK90 - MK91 - MK93 - MR99 MS00 - MS01 - MS02 - MS03 - MS04 - MS05 MS06 - MS07 - MS08 - MS09 - MS10 - MS11 MS12 - MS13 - MS14 - MS15 - MS16 | 180 | 1 ÷ 30 | 200 |
| MS17 - MS18 - MS19 - MS20 - MS21 - MS22 MS23 - MS24 - MS25 - MS26 - MS27 - MS28 MS29 - MS30 - MS31 - MS32 - MS33 - MS34 MS35 - MS36 - MS37 - MS38 - MS39 - MS40 | 240 | | |

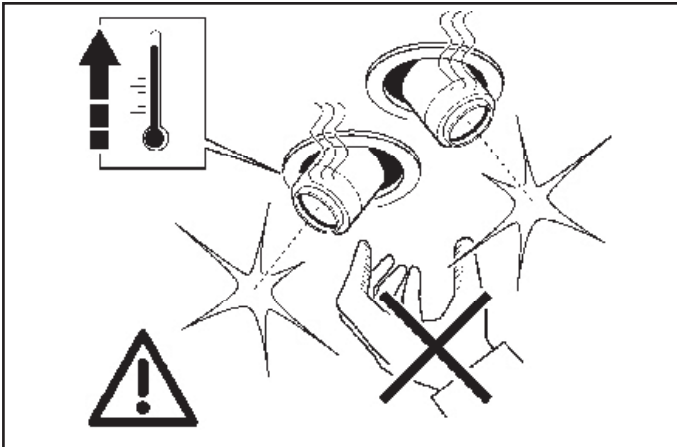
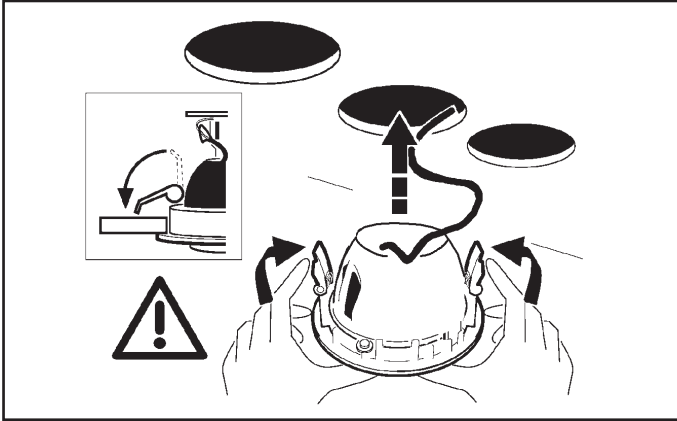
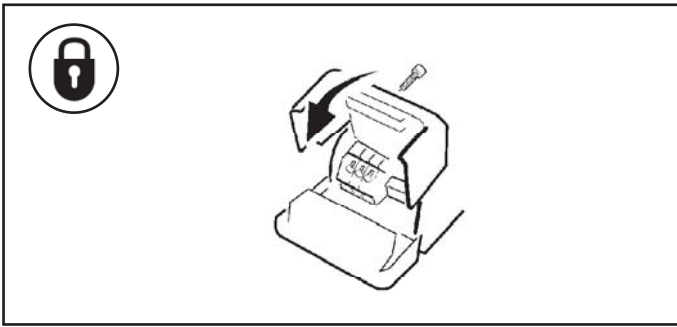



| ART. |  art. |  art. |
|--|--|--|
| MK88 - MK89 - MK90 - MK91 - MK93 - MR99 MS00 - MS01 - MS02 - MS03 - MS04 - MS05 MS06 - MS07 - MS08 - MS09 - MS10 - MS11 MS12 - MS13 - MS14 - MS15 - MS16 | 1191 | MW51 |
| MS17 - MS18 - MS19 - MS20 - MS21 - MS22 MS23 - MS24 - MS25 - MS26 - MS27 - MS28 MS29 - MS30 - MS31 - MS32 - MS33 - MS34 MS35 - MS36 - MS37 - MS38 - MS39 - MS40 | 1192 | MW52 |

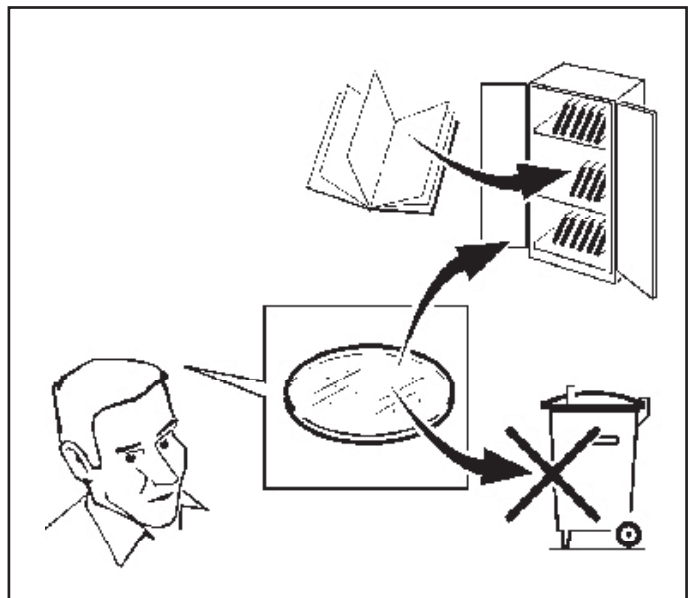
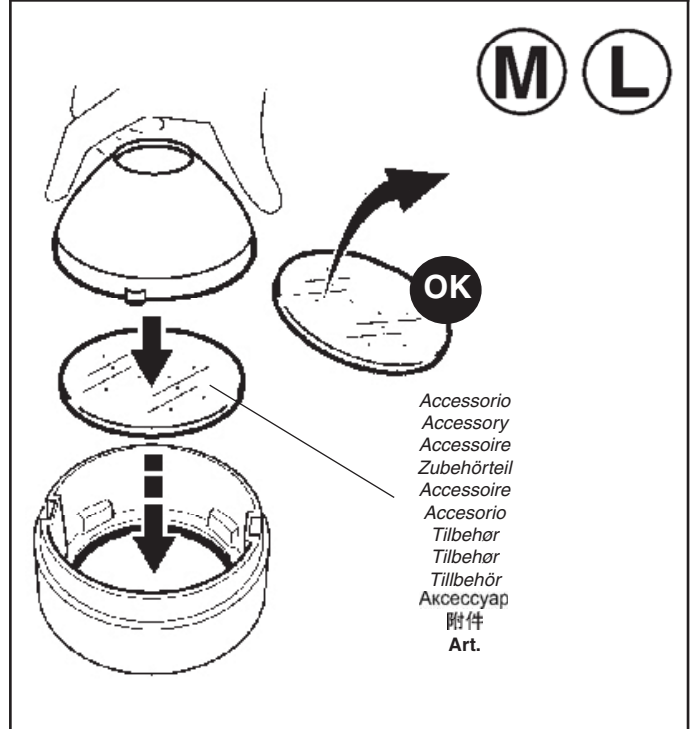
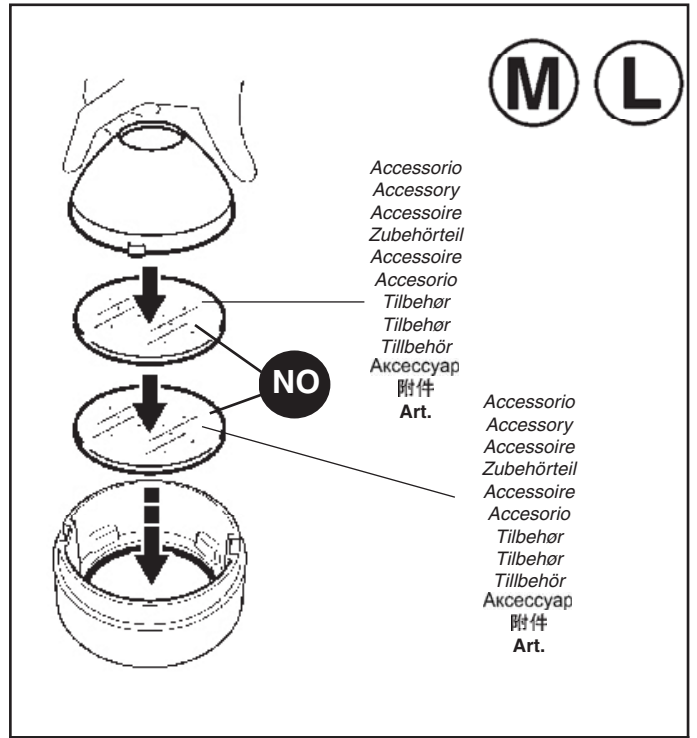
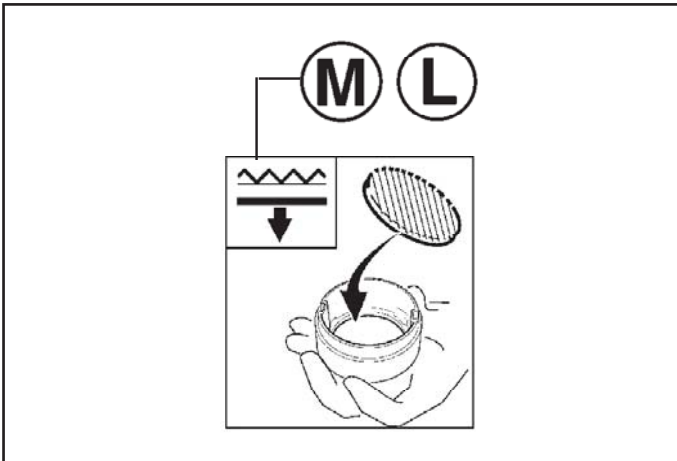

M L

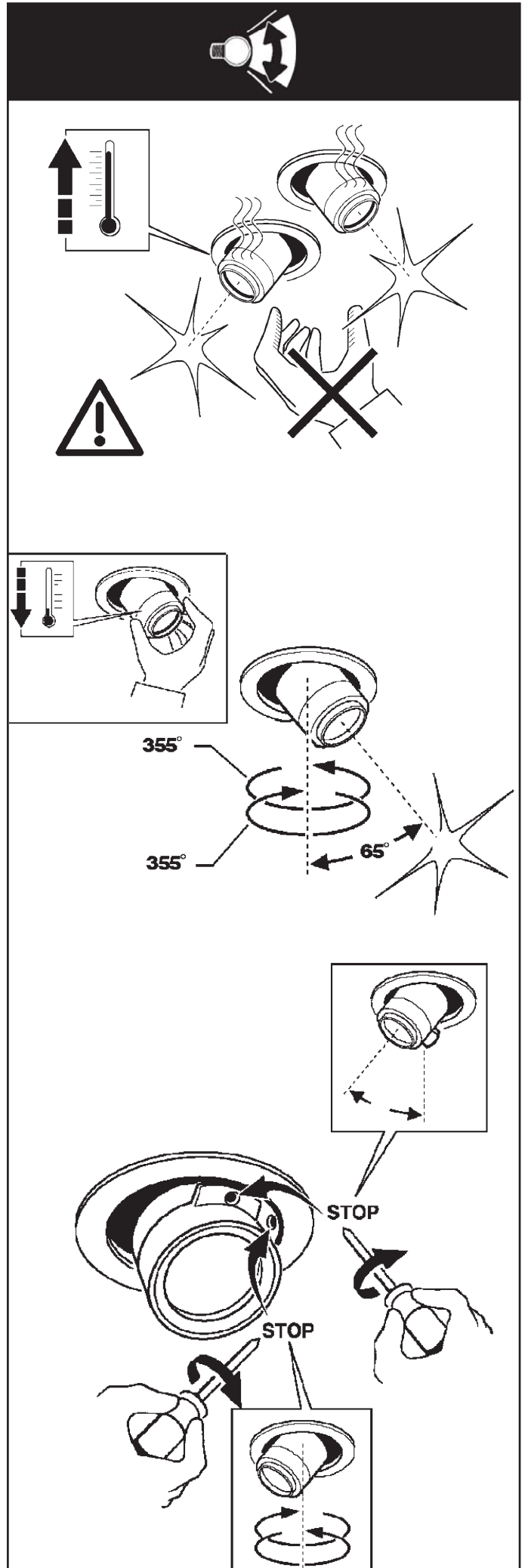
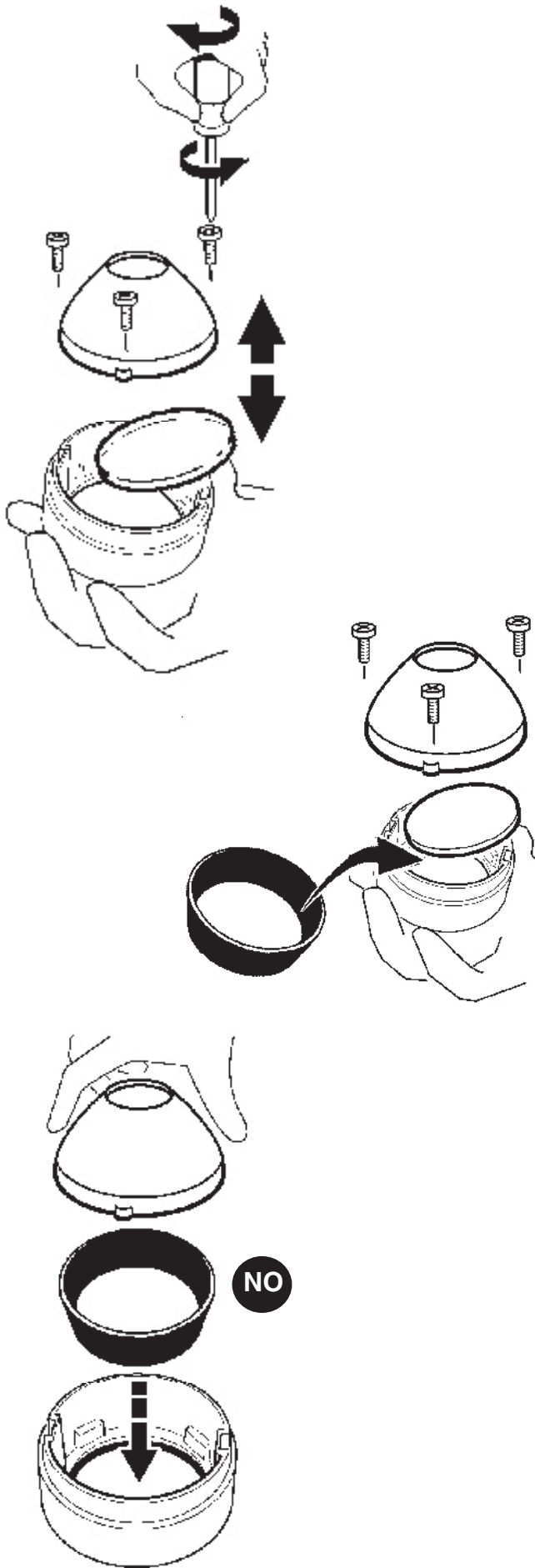



VETRO SODICO-CALCICO TEMPRATO
TEMPERED SODA-LIME GLASS
VERRE SODIQUE-CALCIQUE TEMPRÉ
NATRIUM-KALZIUM-GLAS
GETEMPERD NATRIUMKALKGLAS
CRISTAL SÓDICO-CALCÁREO TEMPLADO
HÆRDET NATRONKALKGLAS
TEMPERERT KALK-NATRON-GLASS
HÅRDAT KALK-SODAGLAS
ЗАКАЛЕННОЕ НАТРИЕВО-КАЛЬЦИЕВОЕ СТЕКЛО
钢化钙钠玻璃

- I *Sostituire lo schermo di protezione danneggiato, richiedendo le specifiche tecniche al costruttore. Non utilizzare l'apparecchio senza lo schermo.*
Attenzione agli oggetti deteriorabili dai raggi U.V. .
- GB *Replace the damaged protective screen, requesting the technical specifications from the manufacturer. Do not use the luminaire without the screen.*
Be careful of the objects that deteriorate when exposed to UV rays.
- F *Remplacez l'écran de protection endommagé en demandant au fabricant les spécifications techniques correspondantes. N'utilisez pas l'appareil sans écran.*
Attention aux objets craignant les rayons U.V.
- D *Ein beschädigter Schutzschirm muß ersetzt werden. Verlangen Sie vom Hersteller Angaben hinsichtlich der technischen Daten. Die Leuchte darf auf keinen Fall ohne diesen Schirm eingesetzt werden.*
Vorsicht bei Artikeln, die durch UV-Strahlen beschädigt werden könnten.
- NL *Vervang het protectiescherm als het beschadigd is en verlang van de fabrikant de juiste technische eigenschappen. Gebruik het apparaat niet zonder het scherm.*
Wees voorzichtig met voorwerpen die door de ultraviolette stralen bedorven kunnen worden.
- E *Sustituir la pantalla de protección dañada solicitando las respectivas especificaciones técnicas al fabricante. No utilizar el aparato sin la pantalla.*
Cuidado con los objetos deteriorables por los rayos ultravioletas.
- DK *Udskift en beskadiget beskyttelseskærm; og spørg fabrikanten til råds vedrørende de tekniske detaljer. Brug ikke armaturet uden skærm.*
Vær opmærksom på genstande, der kan nedbrydes af U.V. stråler.
- N *Skift ut ødelagte verneskjerner, be om tekniske spesifikasjoner fra produsenten. Ikke bruk lysarmaturen uten skjermen.*
Vær forsiktig med gjenstander som forringes ved eksponering for UV-stråler.
- S *Byt ut skadade skyddsskärmar. Rådfråga tillverkaren om tekniska specifikationer. Använd inte utrustningen utan skärmen.*
Var försiktig med föremål som kan skadas av U.V.-strålar.
- RUS *Заменить поврежденный защитный экран, запросив у производителя технические спецификации.*
Не использовать прибор без экрана.
Обращайте внимание на предметы, которые могут быть повреждены под воздействием УФ излучения.
- CN **一旦玻璃破碎后产品将不能再使用，须联系生产商予以更换。**
请勿使用无保护屏的光源。
注意那些受紫外线照射易损坏的物品。

SOSTITUZIONE DEL LED
REPLACING THE LED
REPLACEMENT DE LA LED
AUSTAUSCHEN DER LED
VERVANGEN VAN DE LED
REEMPLAZO DEL LED
UDSKIFTNING AF LYSDIODE
BYTE AV LYSDIOD
UTSKIFTNING AV DEN LYSEMITTERENDE DIODEN
Замена светодиода
发光二极管替换

- I *N.B.: Per la sostituzione del LED contattare l'azienda iGuzzini.*
- GB *N.B.: For information on LED replacement please contact iGuzzini.*
- F *N.B.: Pour procéder au remplacement de la LED, adressez-vous à la société iGuzzini.*
- D *N.B.: Bezüglich des Austausches der LED kontaktieren Sie bitte die Firma iGuzzini.*
- NL *N.B.: Voor het vervangen van de LED neemt u contact op met het bedrijf iGuzzini.*
- E *NOTA: Para sustituir el LED llame a la empresa iGuzzini.*
- DK *N.B.: For udskiftning af lysdioden, skal man kontakte iGuzzini.*
- N *N.B.: For informasjon om skifte av LED, vennligst ta kontakt med iGuzzini.*
- S *OBS! För byte av lysdioden, kontakta företaget iGuzzini.*
- RUS **ПРИМЕЧАНИЕ:** Для замены СИДов обращайтесь в компанию iGuzzini.
- CN **注意：**如需LED更换的信息，请联系iGuzzini。

| 2.518.543.00 IS08261/00 iGuzini | fattore di potenza power factor facteur de puissance Leistungsfaktor vermogensfactor factor de potencia effektfaktor effektfaktor effektfaktor фактор мощности 功率因数 | corrente assorbita absorbed current courant absorbé de puissance Stromaufnahme stroomopname corriente absorbida absorberet strøm absorberet strøm tillford strøm поглощаемая мощность 电源电流 (A) | Vf |
|--|---|--|-----------|
| ART. | | | |
| MK88 - MK89 - MK90 MK91 - MK93 - MR99 MS00 - MS01 - MS02 MS03 - MS04 - MS05 MS06 - MS07 - MS08 MS09 - MS10 - MS11 MS12 - MS13 - MS14 MS15 - MS16 | 0,9 | 0,09 | / |
| MS17 - MS18 - MS19 MS20 - MS21 - MS22 MS23 - MS24 - MS25 MS26 - MS27 - MS28 MS29 - MS30 - MS31 MS32 - MS33 - MS34 MS35 - MS36 - MS37 MS38 - MS39 - MS40 | 0,9 | 0,155 | / |
| MS41 - MS42 - MS43 - MS44 | / | 0,6 | 3,5 |
| MS45 - MS46 - MS47 - MS48 | / | 0,6 | 10,5 |
| MS49 | / | 0,5 R - 0,6 GB | |
| MS50 - MS51 - MS52 - MS53 | / | 0,6 | 7,5 |
| MS54 - MS55 - MS56 - MS57 | / | 0,6 | 11,5 |
| MS58 - MS59 - MS60 - MS61 | 0,9 | 0,05 | / |
| MS62 | | 0,2 | |
| MS63 - MS64 - MS65 - MS66 | 0,9 | 0,09 | |
| MS67 | | 0,2 | |
| MS71 - MS72 | 0,6 | 0,11 | |
| MS73 MS74 | 0,95 | 0,2 | |
| MS77 - MS78 | 0,9 | 0,2 | |
| MS79 - MS80 | | 0,36 | |
| MS82 | 0,9 | (35W)0,2 - (70W)0,36 | |
| MS83 - MS84 | | (35W)0,2 (50W)0,24 (70W)0,36 (100W)0,47 | |
| MS85 - MS86 | 0,9 | 0,7 | |
| MS87 - MS88 | 0,9 | (50W)0,24 - (100W)0,47 | |
| MS92 - MS93 | 0,9 | 0,11 | |
| MS94 - MS95 - MS98 - MS99 MT04 | 0,9 | 0,2 | |
| MT00 - MT01 - MT06 | 0,9 | 0,36 | |
| MT02 - MT03 - MT05 | 0,9 | 0,24 | |
| MT07 | 0,9 | (35W)0,2 (50W)0,24 (70W)0,36 (100W)0,47 | |
| MT08 | 0,9 | 0,7 | |
| MT09 | 0,95 | (50W)0,24 - (100W)0,47 | |

| 2.518.543.00 IS08261/00 iGuzini | fattore di potenza power factor facteur de puissance Leistungsfaktor vermogensfactor factor de potencia effektfaktor effektfaktor effektfaktor фактор мощности 功率因数 | corrente assorbita absorbed current courant absorbé de puissance Stromaufnahme stroomopname corriente absorbida absorberet strøm absorberet strøm tillford strøm поглощаемая мощность 电源电流 (A) | Vf |
|--|---|--|-----------|
| ART. | | | |
| MK88 - MK89 - MK90 MK91 - MK93 - MR99 MS00 - MS01 - MS02 MS03 - MS04 - MS05 MS06 - MS07 - MS08 MS09 - MS10 - MS11 MS12 - MS13 - MS14 MS15 - MS16 | 0,9 | 0,09 | / |
| MS17 - MS18 - MS19 MS20 - MS21 - MS22 MS23 - MS24 - MS25 MS26 - MS27 - MS28 MS29 - MS30 - MS31 MS32 - MS33 - MS34 MS35 - MS36 - MS37 MS38 - MS39 - MS40 | 0,9 | 0,155 | / |
| MS41 - MS42 - MS43 - MS44 | / | 0,6 | 3,5 |
| MS45 - MS46 - MS47 - MS48 | / | 0,6 | 10,5 |
| MS49 | / | 0,5 R - 0,6 GB | |
| MS50 - MS51 - MS52 - MS53 | / | 0,6 | 7,5 |
| MS54 - MS55 - MS56 - MS57 | / | 0,6 | 11,5 |
| MS58 - MS59 - MS60 - MS61 | 0,9 | 0,05 | / |
| MS62 | | 0,2 | |
| MS63 - MS64 - MS65 - MS66 | 0,9 | 0,09 | |
| MS67 | | 0,2 | |
| MS71 - MS72 | 0,6 | 0,11 | |
| MS73 MS74 | 0,95 | 0,2 | |
| MS77 - MS78 | 0,9 | 0,2 | |
| MS79 - MS80 | | 0,36 | |
| MS82 | 0,9 | (35W)0,2 - (70W)0,36 | |
| MS83 - MS84 | | (35W)0,2 (50W)0,24 (70W)0,36 (100W)0,47 | |
| MS85 - MS86 | 0,9 | 0,7 | |
| MS87 - MS88 | 0,9 | (50W)0,24 - (100W)0,47 | |
| MS92 - MS93 | 0,9 | 0,11 | |
| MS94 - MS95 - MS98 - MS99 MT04 | 0,9 | 0,2 | |
| MT00 - MT01 - MT06 | 0,9 | 0,36 | |
| MT02 - MT03 - MT05 | 0,9 | 0,24 | |
| MT07 | 0,9 | (35W)0,2 (50W)0,24 (70W)0,36 (100W)0,47 | |
| MT08 | 0,9 | 0,7 | |
| MT09 | 0,95 | (50W)0,24 - (100W)0,47 | |

- I Istruzioni per le operazioni di servizio per l'apparecchio di illuminazione**
GB Instructions on luminaire service operations
F Instructions pour les opérations de service du luminaire
D Wartungsanleitung für die Leuchte
NL Instructies voor de onderhoudsoperaties op de verlichtingsarmatuur
E Instrucciones para las operaciones de servicio del aparato de alumbrado
DK Anvisninger i serviceindgreb på belysningsarmatur
N Anvisninger for betjening av lysapparatet
S Instruktioner för användning av belysningsanordningen
RUS Инструкции по эксплуатации осветительного прибора
CN 照明装置检修操作说明

Sostituire la lampada parzialmente esausta
 Replace the partly exhausted lamp
 Remplacer la lampe partiellement épuisée
 Die teilweise erschöpfte Lampe austauschen
 Vervang de gedeeltelijk lege lamp
 Sustituir la lámpara parzialmente agotada
 Udskift den delvist udtjente pære
 Skifte ut den delvis utbrente lyspæren
 Byt ut den delvis förbrukade lampan
 Замена частично отработанной лампочки
 更换部分老化的灯泡



Spegnimento
 Switch it off
 Extinction
 Ausschaltung
 Uitschakeling
 Apagado
 Slukning
 Slukking
 Släckning
 Выключение
 关灯

Interrompere l'alimentazione dell'apparecchio
 Cut the power supply to the luminaire
 Couper l'alimentation du luminaire
 Stromversorgung der Leuchte unterbrechen
 Onderbreek de voeding van het apparaat
 Interrumpir la alimentación del aparato
 Afbryd armaturets strømforsyning
 Avbryte strømtilførselen til apparatet
 Koppla från anordningens strömförsörjning
 Отключить электропитание прибора
 中断装置供电



Aprire l'apparecchio
 Open the fixture
 Ouvrir le luminaire
 Das Gerät öffnen
 Open het apparaat
 Abrir el aparato
 Åbn armaturet
 Åpne apparatet
 Öppna anordningen
 Раскрыть прибор
 打开装置



Rimuovere la lampada esausta
 Remove the exhausted lamp
 Retirer la lampe épuisée
 Die alte Lampe entnehmen
 Verwijder de lege lamp
 Quitar la lámpara agotada
 Tag den udtjente pære ud
 Fjerne den utbrente lyspæren
 Ta bort den förbrukade lampan
 Вынуть старую лампочку
 取出老化的灯泡

Portarla in un centro di riciclaggio
 Carry it to a recycling centre
 La porter dans une déchetterie pour son recyclage
 Ordnungsgemäß entsorgen
 Breng de lamp naar een recyclingcentrum
 Llevarla a un centro de reciclaje
 Aflever den på en genbrugsstation
 Lever den til en miljøstasjon
 Lämna in den till en återvinningsanläggning
 Сдать ее в пункт приема утильсырья
 将其送往回收中心



Inserire la nuova lampada
 Introduce the new lamp
 Installer la lampe neuve
 Die neue Lampe einsetzen
 Doe de nieuwe lamp op zijn plek
 Montar la nueva lámpara
 Sæt den nye pære i
 Sette i den nye pæren
 Sätt i den nya lampan
 Вставить новую лампочку
 装入新灯泡

Inserire la nuova lampada nel portalampana
 Fit the new lamp into the socket
 Installer la nouvelle lampe dans le support de lampe
 Die neue Lampe in den Sockel einsetzen
 Doe de nieuwe lamp in de lamphouder
 Montar la nueva lámpara en el portalampana
 Sæt den nye pære i fatningen
 Sette den nye pæren inn i lampeholderen
 Sätt i den nya lampan i lamphållaren
 Вставить новую лампочку в патрон
 将新灯泡插入灯泡架中



Riposizionare ottica
 Re-place the optic
 Remettre l'optique à sa place
 Die Optik wieder einsetzen
 Doe de optiek weer op zijn plaats
 Volver a montar la óptica
 Sæt den optiske enhed på plads
 Innstille linsen
 Flytta om optiken
 Отрегулировать линзы
 重新定位光头



Effettuare prova di funzionamento
 Perform operative test
 Procéder à un essai de fonctionnement
 Eine Funktionsprüfung durchführen
 Controleer de correcte werking
 Hacer una prueba de funcionamiento
 Afprøv funktionen
 Prøve om den fungerer
 Utför funktionstest
 Выполнить проверку исправности работы
 执行功能测试



I Istruzioni per la pulizia dell'apparecchio di illuminazione
GB Instructions on luminaire cleaning operations
F Instructions pour le nettoyage du luminaire
D Anweisungen zur Reinigung der Leuchte
NL Instructies voor de reiniging van de verlichtingsarmatuur
E Instrucciones para limpiar el aparato de alumbrado
DK Anvisninger i rengøring af belysningsarmaturet
N Anvisninger for rengjøring av lysapparatet
S Instruktioner för rengöring av belysningsanordningen
RUS Инструкции по чистке осветительного прибора
CN 照明装置清洁说明

Pulire l'apparecchio
Clean the fixture
Nettoyer le luminaire
Das Gerät reinigen
Reinig het apparaat
Limpiar el aparato
Rengør armaturet
Rengjøre apparatet
Rengör anordningen
Чистка прибора
清洁装置

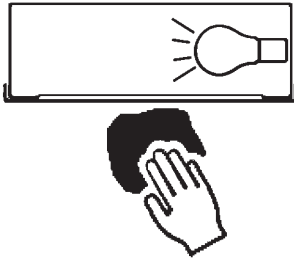

Spegnimento
Switch it off
Extinction
Ausschaltung
Uitschakeling
Apagado
Slukning
Slukking
Släckning
Выключение
关灯

Interrompere l'alimentazione dell'apparecchio
Cut the power supply to the luminaire
Couper l'alimentation du luminaire
Stromversorgung der Leuchte unterbrechen
Onderbreek de voeding van het apparaat
Interrumpir la alimentación del aparato
Afbryd armaturets strømforstyrning
Avbryt strømtilførselen til apparatet
Koppla från anordningens strömförsörjning
Отключить электропитание прибора
中断装置供电



Spolverare l'ottica esterna
Remove dust from the external optic
Dépoussiérer l'optique extérieure
Die externe Optik abstauben
Stof de externe optiek af
Quitar el polvo de la óptica exterior
Tør støvet af den udvendige optiske enhed
Fjerne støv fra den eksterne lysenheden
Damma av den yttre optiken
Вытереть пыль с внешней стороны линз
为外侧光头掸尘

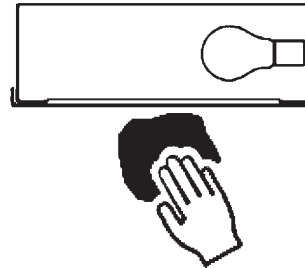

Lavare l'ottica esterna
Wash the external optic
Laver l'optique extérieure
Die externe Optik waschen
Was de externe optiek
Lavar la óptica exterior
Vask den udvendige optiske enhed
Vaske den eksterne lysenheden
Rengör den yttre optiken
Вымыть линзы с внешней стороны
清洁外光头

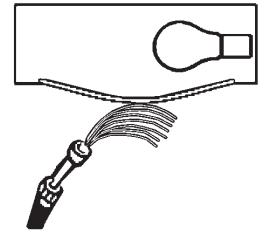

Rimuovere l'ottica
Remove the optic
Retirer l'optique
Die Optik abnehmen
Verwijder de optiek
Quitar la óptica
Tag den optiske enhed af
Fjerne lysenheden
Ta bort optiken
Снять линзы
取下光头



Pulire la parte interna dell'apparecchio di illuminazione
Clean the inside of the fixture
Nettoyer l'intérieur du luminaire
Die Innenseite der Leuchte reinigen
Reinig de binnenzijde van de verlichtingsarmatuur
Limpiar el interior del aparato de alumbrado
Rengør belysningsarmaturets indvendige dele
Rengjøre lysapparatet innvendig
Rengör belysningsanordningen invändigt
Протереть осветительный прибор изнутри
清洁照明装置内部



Riposizionare ottica
Re-place the optic
Remettre l'optique à sa place
Die Optik wieder einsetzen
Doe de optiek weer op zijn plaats
Volver a montar la óptica
Sæt den optiske enhed på plads
Innstille linsen
Flytta om optiken
Отрегулировать линзы
重新定位光头

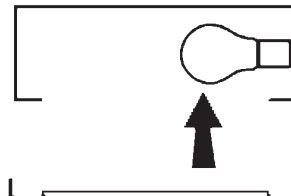

Effettuare prova di funzionamento
Perform operative test
Procéder à un essai de fonctionnement
Eine Funktionsprüfung durchführen
Controleer de correcte werking
Hacer una prueba de funcionamiento
Afprøv funktionen
Prøve om den fungerer
Utför funktionstest
Выполнить проверку исправности работы
执行功能测试

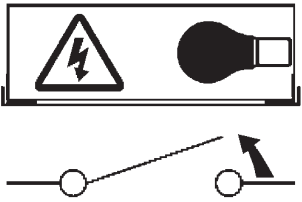
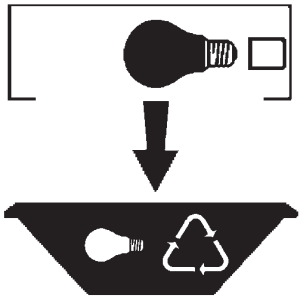
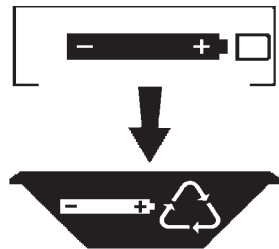
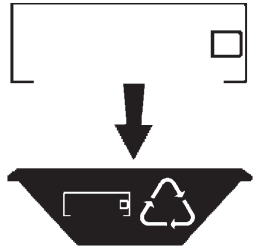

- I Istruzioni per il fine vita e lo smaltimento dei componenti**
GB Instructions on end-of-life and component disposal
F Instructions pour la gestion des composants en fin de vie et leur mise au rebut
D Anweisungen zur Entsorgung der Leuchtenkomponenten
NL Instructies voor het verwijderen van de armatuur en het recyclen van de onderdelen
E Instrucciones para el final de vida y la eliminación los componentes
DK Anvisninger i udtjent armatur og bortskaffelse af komponenter
N Anvisninger for endt levetid og avfallsbehandling av delene
S Instruktionser vid bortskaffning och kassering av komponenter
RUS Инструкции по утилизации прибора и его комплектующих по окончании его срока службы
CN 寿命期结束与零件废弃处置说明

| | | | |
|--|---|---|---|
| <p>Spegnimento Switch it off Extinction Ausschaltung Uitschakeling Apagado Slukning Slukking Släckning Выключение 关灯</p> <p>Interrompere l'alimentazione dell'apparecchio Cut the power supply to the luminaire Couper l'alimentation du luminaire Stromversorgung der Leuchte unterbrechen Onderbreek de voeding van het apparaat Interrompirla alimentación del aparato Afbryd armaturets strømforsyning Avbryt strømtilførselen til apparatet Koppla från anordningens strömförsörjning Отключить электропитание прибора 中断装置供电</p>  | <p>Rimuovere la/e lampada/e per la dismissione Remove the lamp(s) for decommissioning Retirer la(les) lampe(s) pour sa(leur) mise au rebut Die Lampe/n ordnungsgemäß entsorgen Verwijder de lamp(en) voor het recyclen Quitar la(s) lámpara(s) para el desecho Tag pæren/pærerne ud til bortskaffelse Fjerne lampen/-e som skal kastes Ta bort lampan/-orna för bortskaffningen Вынуть лампочку/и для утилизации прибора 取出需要丢弃的灯泡</p>  | <p>Rimuovere la batteria per la dismissione Remove the battery for decommissioning Retirer la batterie pour sa mise au rebut Die Batterie ordnungsgemäß entsorgen Verwijder de batterij voor het recyclen Quitar la batería para el desecho Tag batteriet ud til bortskaffelse Fjerne batteriet som skal kastes Ta bort batteriet för bortskaffningen Вынуть батарейку для утилизации прибора 取出需要丢弃的电池</p>  | <p>Rimuovere l'apparecchio per la dismissione Remove the fixture for decommissioning Enlever le luminaire pour sa mise au rebut Das Gerät ordnungsgemäß entsorgen Verwijder het apparaat voor het recyclen Quitar el aparato para el desecho Tag armaturet ud til bortskaffelse Fjerne apparatet som skal kastes Ta bort anordningen för bortskaffningen Снять прибор для утилизации 取出需要丢弃的装置</p>  |
|--|---|---|---|

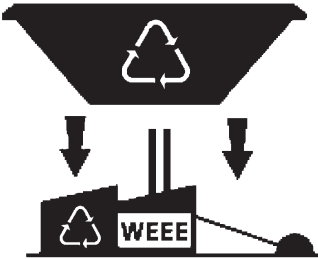
| | | | |
|---|--|--|--|
| <p>Inviare i materiali ad un centro di raccolta RAEE Send the materials to a WEEE collection centre Envoyer les matériaux dans une déchetterie DEEE Die Materialien in einem WEEE-Zentrum entsorgen Zend de materialen naar een recyclingscentrum voor de AEEA Enviar los materiales a un centro de recogida RAEE Afløver materialerne på et indsamlingscenter for elektronisk udstyr Sende materialene til en miljøstasjon for resirkulering av EE-avfall Skicka materialet till en RAEE uppsamlingscentral Сдать материалы в пункт приема утильсырья 将材料送往电气和电子垃圾回收中心</p>  | | | |
|---|--|--|--|