

PIXEL PRO FRAME

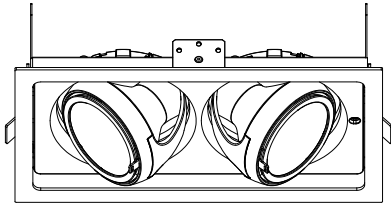

ATTENZIONE:

LA SICUREZZA DELL'APPARECCHIO E' GARANTITA SOLO CON L'USO APPROPRIATO DELLE SEGUENTI ISTRUZIONI; PERTANTO E' NECESSARIO CONSERVARLE.

WARNING:

THE SAFETY OF THIS FIXTURE IS GUARANTEED ONLY IF YOU COMPLY WITH THESE INSTRUCTIONS; REMEMBER TO CONSERVE IN A SAFE PLACE.

ATTENTION:

LA SECURITE DE L'APPAREIL N'EST GARANTIE QU'EN CAS D'UTILISATION CORRECTE DES INSTRUCTIONS SUIVANTES; IL FAUT PAR CONSEQUENT LES CONSERVER.

ACHTUNG:

DIE SICHERHEIT DES GERÄTES WIRD NUR DURCH SACHGEMÄSSE BEFOLGUNG NACHSTEHENDER ANWEISUNGEN GEWÄHRLEISTET; IHRE AUFBEWAHRUNG IST DESHALB SEHR WICHTIG.

OPGELET:

DE VEILIGHEID VAN DI ATOESTEL IS SLECHTS DAN GEGARANDEERD ALS INDIEN DE VOLGENDE INSTRUCTIES STRIKT WORDEN TOEGEPAST: DAAROM MOET MEN ZE OOK BEWAAREN.

ATENCION:

LA SEGURIDAD DEL APARATO SE GARANTIZA SOLO CUMPLIENDO CUIDADOSAMENTE LAS SIGUIENTES INSTRUCCIONES; POR ELLO, ES NECESARIO CONSERVARLAS.

BEMÆRK:

SIKKERHEDEN VED BRUG AF ARMATURET KAN KUN GARANTERES, HVIS DISSE ANVISNINGER FØLGES; SØRG DERFOR FOR AT GEMME DEM.

ADVARSEL:

SIKKERHETEN TIL DETTE APPARATET GARANTERES KUN HVIS DU OVERHOLDER DISSE INSTRUKSJONENE; HUSK Å OPPBEVARE DEM PÅ ET TRYGT STED.

OBSERVERA!

UTRUSTNINGENS SÄKERHET KAN ENDAST GARANTERAS OM DESSA ANVISNINGAR RESPEKTERAS I DETALJ. SPARA DÄRFÖR DESSA ANVISNINGAR FÖR FRAMTIDA KONSULTATION.

ВНИМАНИЕ:

Мы ГАРАНТИРУЕМ БЕЗОПАСНУЮ ЭКСПЛУАТАЦИЮ ИЗДЕЛИЯ ТОЛЬКО ПРИ СОБЛЮДЕНИИ СЛЕДУЮЩИХ ИНСТРУКЦИЙ; С ЭТОЙ ЦЕЛЬЮ НЕОБХОДИМО СОХРАНИТЬ ДАННУЮ БРОШЮРУ.

警告:

为确保该装置安全，请遵守操作指示；并于安全场所放置。

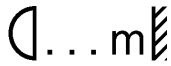
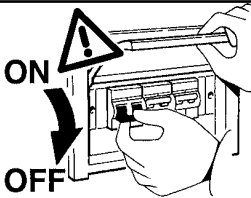
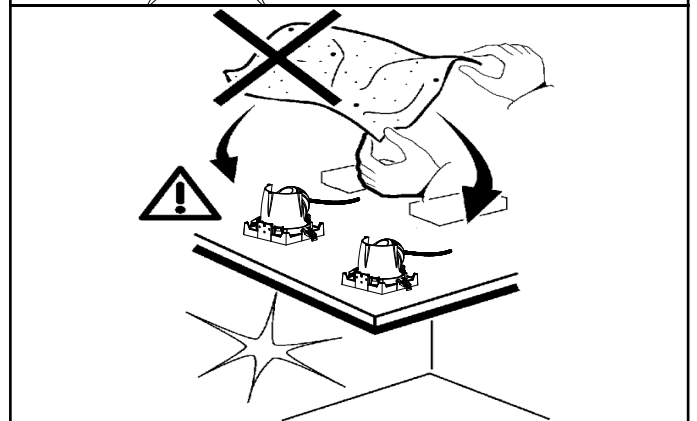
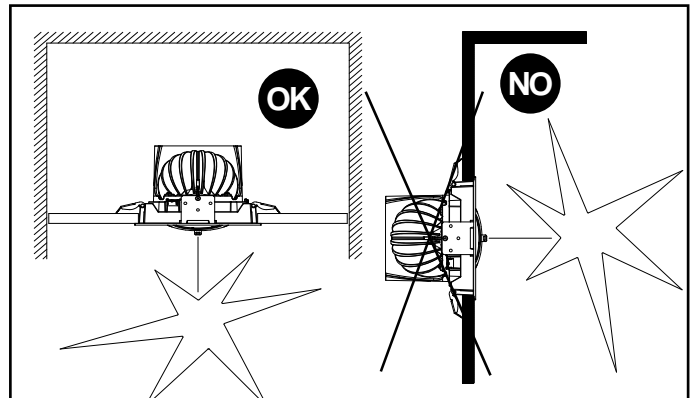
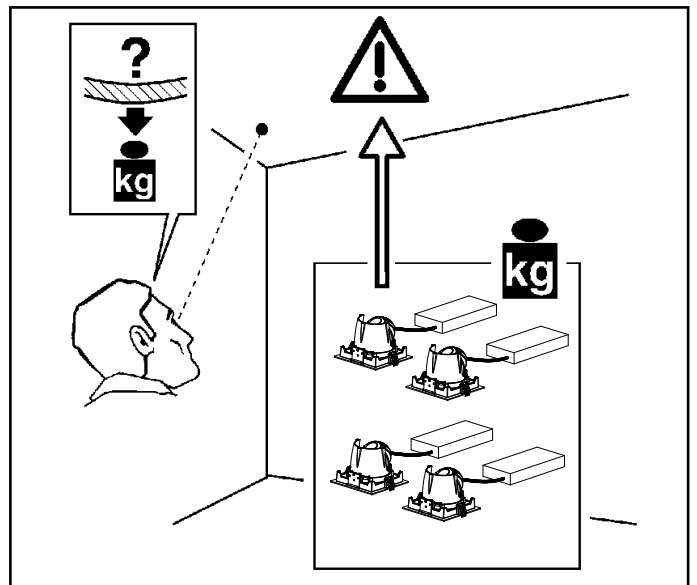
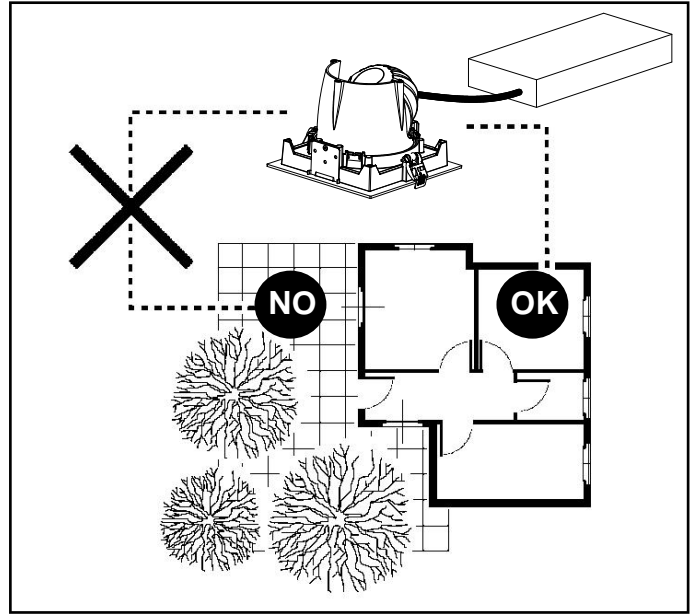

I Rispettare la distanza minima dall'oggetto illuminato, misurata lungo l'asse ottico della lampada.

GB Respect the minimum distance from the illuminated object, measured along the optical axis of the lamp.

F Respectez la distance minimum de l'objet éclairé, mesurée le long de l'axe optique de la lampe.

D Halten Sie bitte den längs zur optischen Achse der Leuchte gemessenen Mindestabstand zum beleuchteten Gegenstand ein.

NL Respecteer de minimum afstand van het verlichte object, gemeten langs de optische as van de lamp.

E Respetar la distancia mínima respecto del objeto iluminado, medida a lo largo del eje óptico de la lámpara.

DK Minimumsafstanden til det oplyste objekt skal overholdes, målt langs lyskildens optiske akse.

N Overhold minsteavstanden fra den oplyste gjenstanden, målt langs den optiske akse til lampen.

RUS Соблюдайте минимальное расстояние от освещенного объекта, измеренное вдоль оптической оси лампы.

CN 保持照明物体沿光源的光轴测量的最小距离。

HIT **OK**

LED **NO**



- I N.B.: L'apparecchio non deve, in alcuna circostanza, essere coperto con materiale isolante o similare.
- GB N.B.: The fixture must not be covered, under any circumstances, by insulating materials or the like.
- F N.B.: L'appareil ne doit, en aucun cas, être couvert par un matériau isolant ou autre.
- D N.B.: Das Gerät darf auf keinen Fall mit Isoliermaterial oder ähnlichem bedeckt werden.
- NL N.B.: Het apparaat mag in geen geval bedekt worden met isoleringsmateriaal of dergelijke.
- E **NOTA:** El aparato no debe ser protegido con material aislante o parecido, por ninguna causa.
- DK N.B.: Armaturet må under ingen omstændigheder tildækkes med isolerende materiale eller lignende materiale.
- N N.B.: Armaturen må ikke under noen omstendigheter tildekkes med isolerende materialer eller lignende.
- S **OBS!** Utrustningen får inte under några omständigheter täckas över med isolerande material.
- RUS **ПРИМЕЧАНИЕ:** Категорически запрещается покрывать прибор изоляционным или подобным материалом.
- CN **警告:** 不管在任何情况下灯具都不能被隔热材料或类似材料覆盖

art. MF04-MF05-MF06-MF07-MF08-MF09-MF10-MF11-MF12-MF13-MF14-MF15-MF16-MF17-MF18-MF19-MF20-MF21-MF22-MF23 -MF24-ML16-ML17-ML18-ML19-ML20-ML21-ML22-ML23-ML24-ML25-ML26-ML27-MP16-MP17-MP18-MP19-MP20-MP21-MP22-MP23-MP24-MP25-MP26-MP27-MP28-MP29-MP30-MP31-MP32-MP33-MP34-MP35-MP36-MP37-MP38-MP39-MP40-MP41-MP42-MP43-MP44-MP45-MP46-MP47-MP49-MP49-MP50-MP51-MP52-MP53-MP54-MP55-MP56-MP57-Q199-Q200-Q201-Q202-Q203-Q204-Q205-Q206-Q207- Q208-Q209-Q210-Q211-Q212-Q213-Q214-Q215-Q216-Q217- Q218-Q219-Q220-Q221-Q222-Q223-Q224-Q225-Q226-Q227- Q228-Q229-Q230-Q231

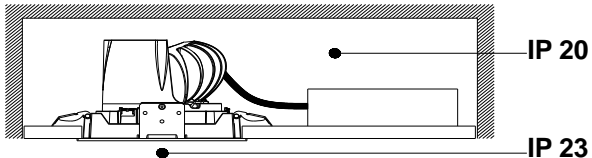

- I Installando il prodotto a plafone in un vano chiuso, il grado di protezione è quello indicato in figura.
- GB If you install the product on the ceiling in a closed room, the degree of protection is that indicated in the figure.
- F En cas d'installation du produit au plafond dans une niche fermée, l'indice de protection est celui qui est indiqué sur la figure.
- D Wenn Sie das Deckenmodell in einem geschlossenen Raum installieren, so entspricht der Schutzgrad den Werten in der Abbildung.
- NL Bij installatie aan het plafond in een gesloten ruimte is de protectiegraad zoals aangegeven in de afbeelding.
- E Instalando el producto como plafón en un compartimento cerrado, el grado de protección es el que se indica en la figura.
- DK Hvis produktet monteres i loftet i et lukket rum, er beskyttelsesgraden som vist i figuren.
- N Hvis du installerer produktet på taket i et lukket rom, er beskyttelsesgraden den som er indikert på figuren.
- S Genom att installera innettaksbelysningen i ett stängt rum, är skyddsgraden densamma som anges i figuren.
- RUS При монтаже плафонного прибора в закрытом отсеке класс электробезопасности будет таким, как указано на схеме.
- CN 如要将产品安装在密闭房间的天花板上, 保护等级如表中所示。

art. MF04 - MF05 - MF06 - MF07 - MF08 - MF09 - MF10 - MF11 - MF12

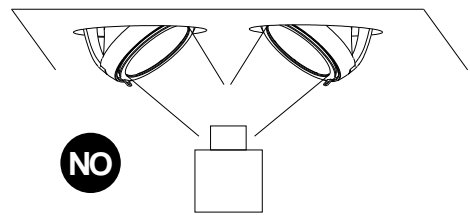

500 X 500 X 150
H=150mm

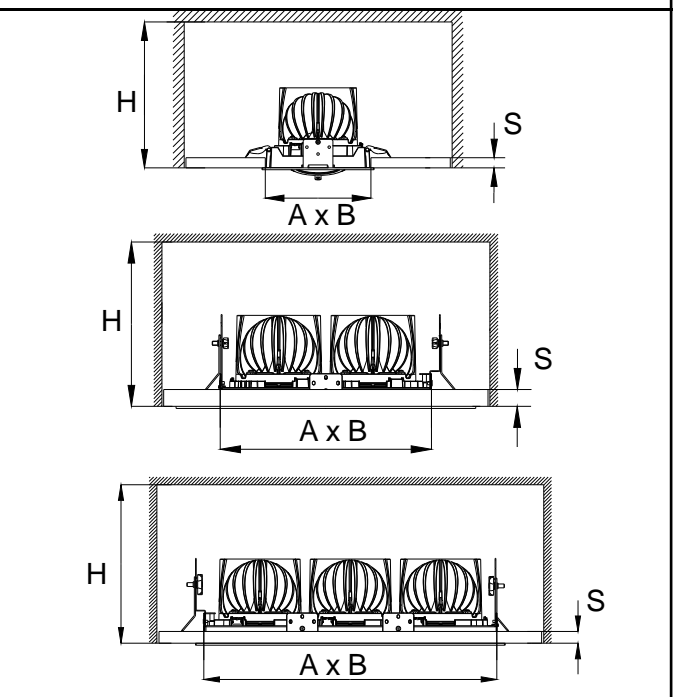
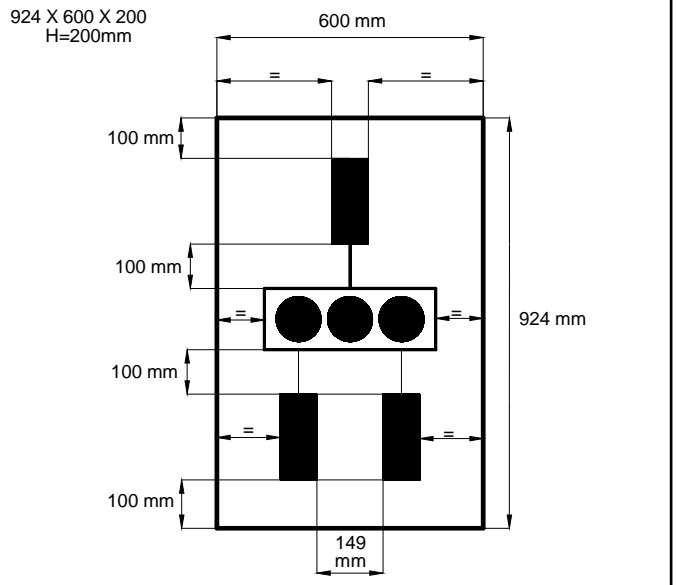
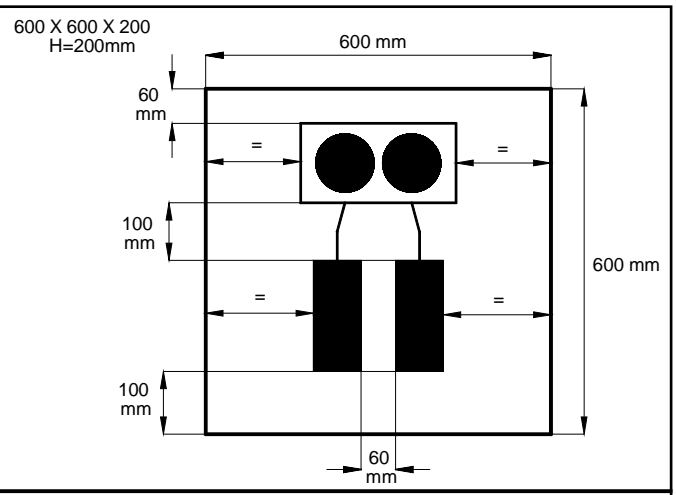
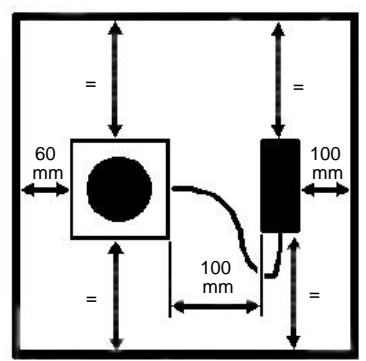

- I Consultare la seguente tabella e praticare il foro sul controsoffitto.
- GB Consult following table and make hole on ceiling.
- F Consulter le tableau suivant et percer un trou dans le faux-plafond.
- D Nachstehende Tabelle zu Rate ziehen und ein Loch in der Hängedecke bohren.
- NL Raadpleeg de volgende tabel en maak het gat in het verlaagde plafond.
- E Consultar el cuadro siguiente antes de taladrar los orificios en el falso techo.
- DK Der henvises til følgende tabel ved boring af huller i det forsænkede loft.
- N Se følgende tabell og bore hull i himlingen.
- S Se följande tabell och borra hålet i taket.
- RUS Смотрите таблицу ниже для расчета проема в фальш-потолке.
- CN 参考下面的图表, 在天花板上打孔。

ART.	mm			
	H min	S	A	B
MF04-MF05-MF06 MF13-MF14-MF15 MF16-ML16-ML17 ML18-ML19-MP16 MP17-MP18-MP19 MP20-MP21-MP22 MP37-MP38-MP39 MP40-MP41-MP42 MP43- Q199- Q200 Q201- Q202- Q203 Q204- Q205- Q206 Q207- Q208- Q209	150	1÷20	142	142
MF07-MF08-MF09 MF17-MF18-MF19 MF20-ML20-ML21 ML22-ML23-MP23 MP24-MP25-MP26 MP27-MP28-MP29 MP44-MP45-MP46 MP47-MP48-MP49 MP50- Q210- Q211 Q212- Q213- Q214 Q215- Q216- Q217 Q218- Q219- Q220	200	1÷20	270	138
MF10-MF11-MF12 MF21-MF22-MF23 MF24-ML24-ML25 ML26-ML27-MP30 MP31-MP32-MP33 MP34-MP35-MP36 MP51-MP52-MP53 MP54-MP55-MP56 MP57- Q221- Q222 Q223- Q224- Q225 Q226- Q227- Q228 Q229- Q230- Q231	200	1÷20	386	138

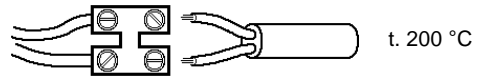
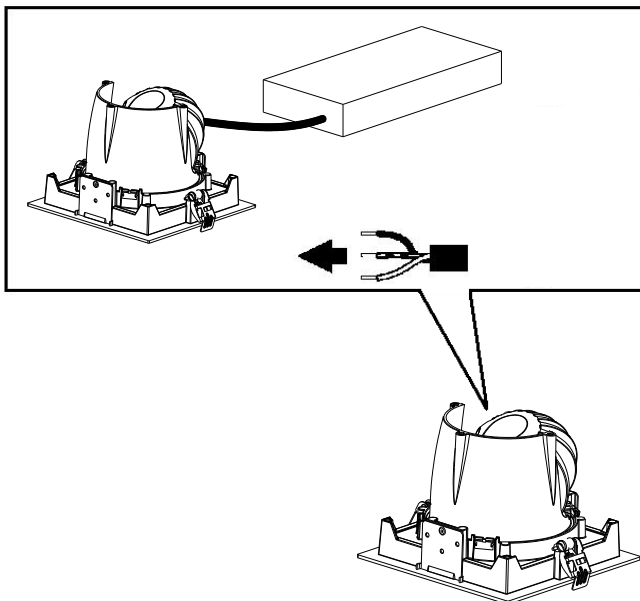
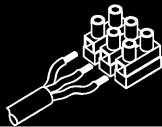

- I Per il cablaggio elettrico utilizzare cavi con doppio isolamento.
N.B.: Utilizzare per il collegamento alla rete cavi resistenti alle alte temperature.
- GB For the electrical wiring use cables with double insulation.
N.B.: For connection to the main, use cables which are resistant to high temperatures.
- F Pour le câblage électrique, utiliser des câbles à double isolation.
N.B.: Pour le raccordement au réseau, utilisez des câbles résistant à de hautes températures.
- D Für die elektrische Verdrahtung sind Kabel mit Mantel zu verwenden.
N.B.: Für den Netzanschluß hitzebeständige Kabel verwenden.
- NL Gebruik dubbel-geïsoleerde kabels voor de elektrische aansluiting.
N.B.: Voor aansluiting aan het net moet men hittebestendige kabels gebruiken.
- E Para el cableado eléctrico servirse de cables con doble aislamiento.
NOTA: Para la conexión a la red, utilizar cables de resistencia elevada a temperaturas.
- DK De anvendte ledninger skal have dobbelt isolering.
N.B.: Brug ledninger, der kan tåle høje temperaturer, ved tilslutning til forsyningsnettet.
- N For elektrisk kabling, bruk kabler med dobbel isolering.
N.B.: For tilkopling til strømmettet, bruk kabler som er motstandsdyktige mot høye temperaturer.
- S Для монтажа кабелепроводки используйте провода с двойной изоляцией.
ПРИМЕЧАНИЕ: Для подсоединения к сети используйте кабели, устойчивые к высокой температуре.
- RUS Для монтажа кабелепроводки используйте провода с двойной изоляцией.
ПРИМЕЧАНИЕ: Для подсоединения к сети используйте кабели, устойчивые к высокой температуре.
- CN 连接电线请用双隔离电缆。
注意: 为与干线连接, 使用耐高温电缆。

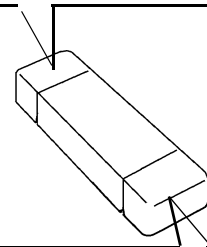
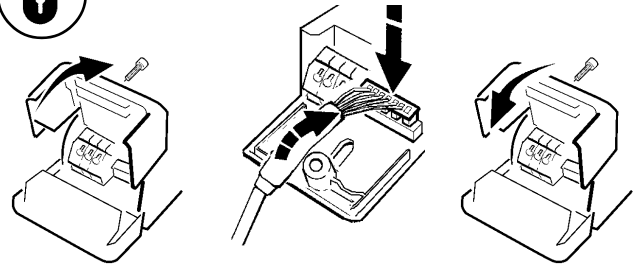

ALIMENTAZIONE
POWER SUPPLY
ALIMENTATION
EINSPEISUNG
STROOMVERZORGING
ALIMENTACION
STRØMFORSYNING
STRØMFORSYNING
ELFÖRSÖRJNING
ЭЛЕКТРОПИТАНИЕ
电源

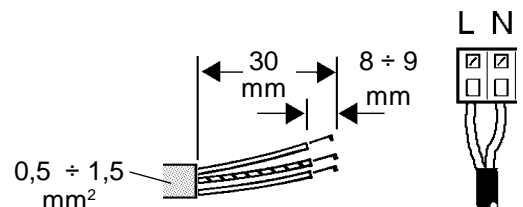
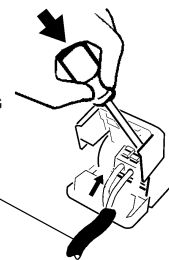

DALI

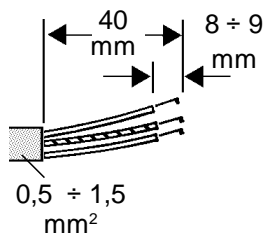
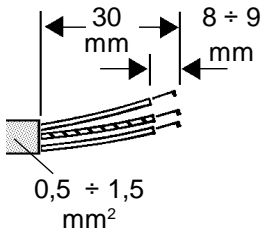
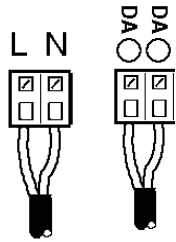
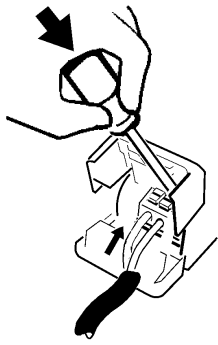

ALIMENTAZIONE
POWER SUPPLY
ALIMENTATION
EINSPEISUNG
STROOMVERZORGING
ALIMENTACION
STRØMFORSYNING
STRØMFORSYNING
ELFØRSØRJNING
ЭЛЕКТРОПИТАНИЕ
电源

LINEA PER DIMMERAZIONE(DALI)
LINE FOR DIMMING(DALI)
LIGNE POUR GRADATION(DALI)
PRODUKTLINJE ZUR DIMMUNG(DALI)
LIJN VOOR DIMMER(DALIA)
LINEA PARA REGULACI6N INTENSIDAD
LUMINOSA(DALI)
KREDS TIL DÆMPNING(DALI)
DIMMERLINJE(DALI)
DIMMERLINJE (DALI)
ЛИНИЯ ДЛЯ РЕГУЛЯЦИИ МОЩНОСТИ СВЕТА ЛАМПЫ(DALI)
调光线 (DALI)

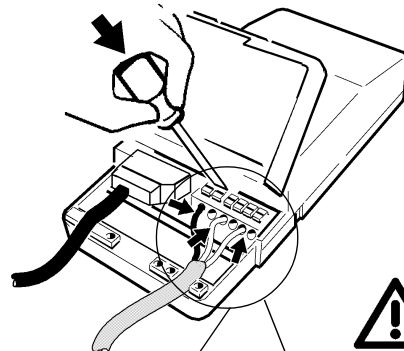
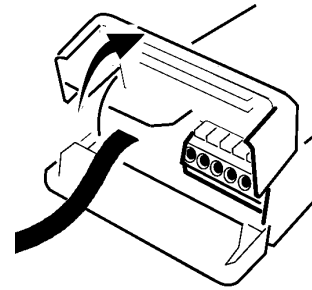

ALIMENTAZIONE
POWER SUPPLY
ALIMENTATION
EINSPEISUNG
STROOMVERZORGING
ALIMENTACION
STRØMFORSYNING
STRØMFORSYNING
ELFØRSØRJNING
ЭЛЕКТРОПИТАНИЕ
电源

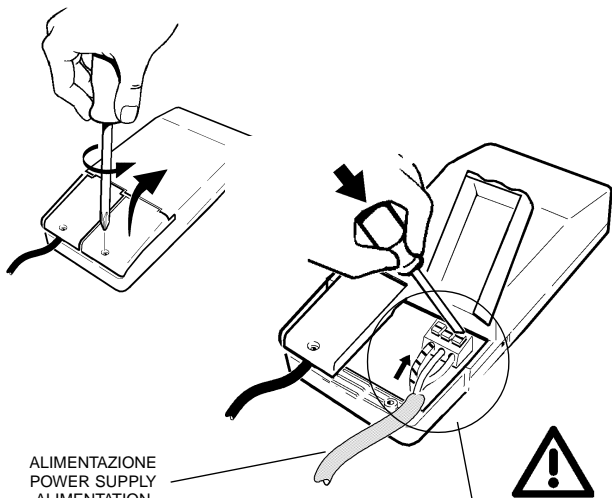

ALIMENTAZIONE
POWER SUPPLY
ALIMENTATION
EINSPEISUNG
STROOMVERZORGING
ALIMENTACION
STRØMFORSYNING
STRØMFORSYNING
ELFØRSØRJNING
ЭЛЕКТРОПИТАНИЕ
电源

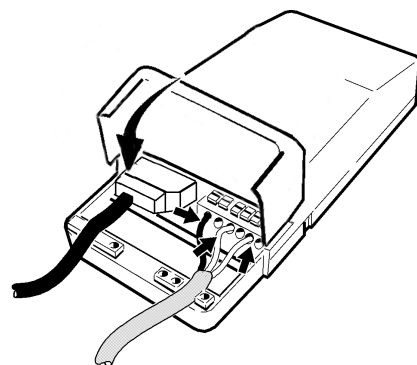
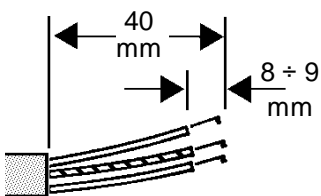
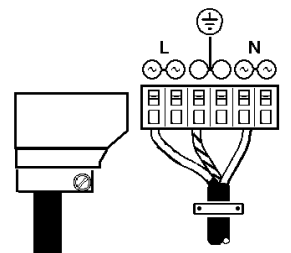
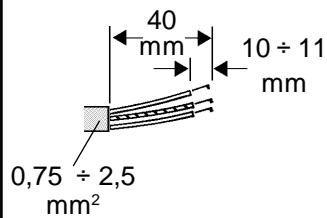

DALI

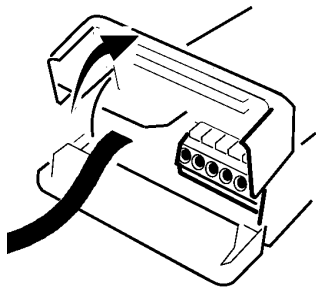

ALIMENTAZIONE
POWER SUPPLY
ALIMENTATION
EINSPEISUNG
STROOMVERZORGING
ALIMENTACION
STRØMFORSYNING
STRØMFORSYNING
ELFÖRSÖRJNING
ЭЛЕКТРОПИТАНИЕ
电源

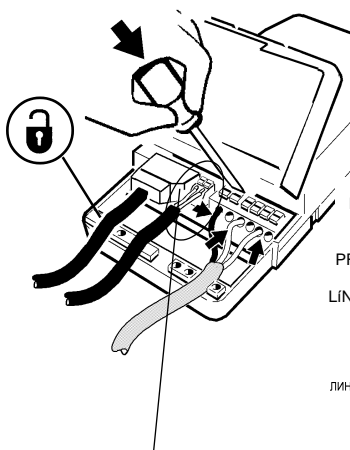
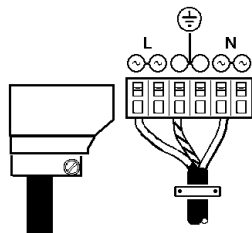
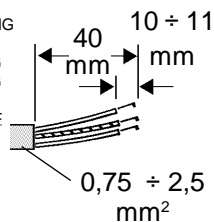

LINEA PER DIMMERAZIONE(DALI)
LINE FOR DIMMING(DALI)
LIGNE POUR GRADATION(DALI)
PRODUKTLINIE ZUR DIMMUNG(DALI)
LIJN VOOR DIMMER(DALIA)
LINEA PARA REGULACIÓN INTENSIDAD LUMINOSA(DALI)
KREDS TIL DÆMPNING(DALI)
DIMMERLINJE(DALI)
DIMMERLINJE (DALI)
ЛИНИЯ ДЛЯ РЕГУЛЯЦИИ МОЩНОСТИ СВЕТА ЛАМПЫ(DALI)
调光线 (DALI)

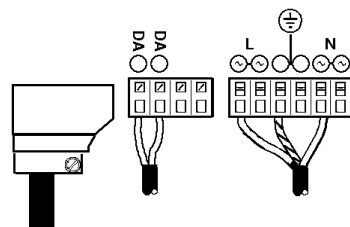
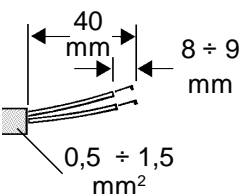

DALI

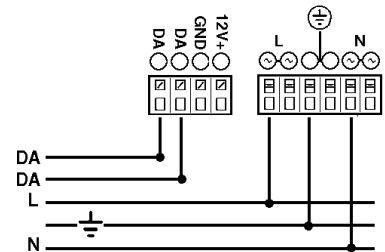

TOUCH DIM

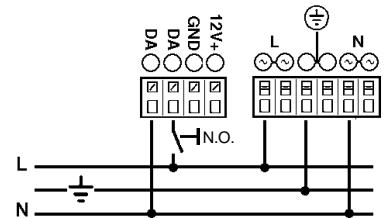

- I I dispositivi con cablaggio digitale possono essere dimmerati con dispositivi DALI o con pulsante normalmente aperto (N.O.) da collegare come da schema.
- GB Devices with digital control gear may be dimmed using DALI devices or a normally-open button (N.O.) to be connected as shown in the diagram.
- F Les articles à câblage numérique peuvent fonctionner avec des variateurs à dispositifs DALI ou à bouton poussoir normalement ouvert (N.O.) à relier conformément au schéma.
- D Die Geräte mit digitaler Verkabelung können mit Hilfe von DALI-Vorrichtungen oder mit Hilfe eines gemäß Schaltplan anzuschließenden Schließers (N.O.) gedimmt werden.
- NL De producten met digitale bekabeling kunnen worden gedimd met DALI systemen of met een N.O. (normally open) knop, die moet worden aangesloten volgens schema.
- E Los dispositivos con cableado digital pueden regularse con dispositivos DALI o con un interruptor de botón normalmente abierto (N.O.) que se conecta según ilustrado en el esquema.
- DK Produkter med digital kabelføring kan dæmpes med DALI-anordninger eller med kontakten, som normalt er åben (N.O.) og som skal tilsluttes, som vist.
- N Produkter med digitalkabler kan dimmes med DALI-anordninger eller med en normalt åpen (NO) trykkbryter som kobles som vist i koblings skjema.
- S Produkter med digital kabeldragning kan föröses med dimmer. Detta kan göras med DALI-anordningarna eller med en normalt öppen kontakt (N.O.) som ska anslutas enligt schemat.
- RUS Интенсивность приборов с цифровой проводкой может регулироваться посредством устройств DALI или нормально разомкнутой кнопкой (Н.Р.), подсоединяемой согласно схеме.
- CN 带有数字控制装置的设备可以通过 DALI (数字化寻址调光接口) 设备或者一个连接方式如图中所示的常开按钮 (N.O.) 进行亮度调节

- I Pilotare diversi prodotti DALI tramite pulsante (es: Touch-dim, Switch-dim, Push-dim, Direct-dim, etc.) potrebbe causare dei problemi di sincronizzazione tra gli stessi. È possibile ovviare a questo problema dotandosi di dispositivi aggiuntivi. Per maggiori informazioni vi invitiamo a contattarci direttamente.
- GB Controlling different DALI products through buttons (e.g.: Touch-dim, Switch-dim, Push-dim, Direct-dim, etc.) may lead to product synchronisation problems. This problem can be overcome by using additional devices. For further information, please contact us directly.
- F Piloter plusieurs produits DALI par bouton (ex : Touch-dim, Switch-dim, Push-dim, Direct-dim, etc.) pourrait causer des problèmes de synchronisation entre eux. Ce problème peut être évité en s'équipant de dispositifs supplémentaires. Pour de plus amples renseignements, veuillez nous contacter directement.
- D Die Steuerung verschiedener DALI-Produkte mittels Taste (z.B.: Touch-dim, Switch-dim, Push-dim, Direct-dim etc.) kann eventuell zu Synchronisierungsproblemen zwischen diesen führen. Dieses Problem lässt sich durch den Einsatz von zusätzlichen Geräten beheben. Wenn Sie weitere Informationen wünschen, setzen Sie sich bitte direkt mit uns in Verbindung.
- NL Het besturen van verschillende DALI producten m.b.v. dezelfde knop (bv.: Touch-dim, Switch-dim, Push-dim, Direct-dim, etc.) kan synchronisatieproblemen tussen de producten opleveren. Men kan dit probleem voorkomen door extra systemen aan te sluiten. Voor verdere informatie raden we u aan direct contact met ons op te nemen.
- E El mando de varios productos DALI por tecla (ej: Touch-dim, Switch-dim, Push-dim, Direct-dim, etc.) podría causar problemas de sincronización entre ellos. Es posible prevenir este problema utilizando dispositivos adicionales. Para más información, contacte directamente con nosotros.
- DK Hvis DALI-produkterne styres ved hjælp af knapperne (fx. Touch-dim, Switch-dim, Push-dim, Direct-dim osv.), kan det skabe problemer med synkronisering af samme. Dette problem kan undgås, hvis man køber ekstra enheder. For yderligere oplysninger, kontakt os direkte.
- N Å styre ulike DALI-produkter ved hjelp av en trykknappbryter (f.eks. touch-dim, switch-dim, push-dim, direct-dim, osv.) vil kunne føre til problemer med synkroniseringen mellom dem. Dette problemet kan løses ved hjelp av noen tilleggsinnretninger. Ta gjerne kontakt med oss for mer informasjon om dette.
- S Styrning av olika DALI-produkter med knapp (t.ex.: Touch-dim, Switch-dim, Push-dim, Direct-dim o.s.v.) kan orsaka synkroniseringsproblem mellan dessa. Detta problem kan åtgärdas med tillägsanordningar. För mer information kan du kontakta oss direkt.
- RUS Управление различными продуктами DALI с помощью кнопки (напр.: Touch-dim, Switch-dim, Push-dim, Direct-dim и пр.) может вызвать проблемы синхронизации между ними. Эту проблему можно устранить путем воздействия дополнительных устройств. За получением более подробной информации просим Вас связаться с нами непосредственно.
- CN 通过按钮控制不同的 DALI 产品 (例如: 触摸调光、切换调光、按钮调光、直接调光等) 可能会导致产品的同步问题。该问题可通过使用其他额外的装置加以克服。如需了解更多信息, 请直接与我们联系。

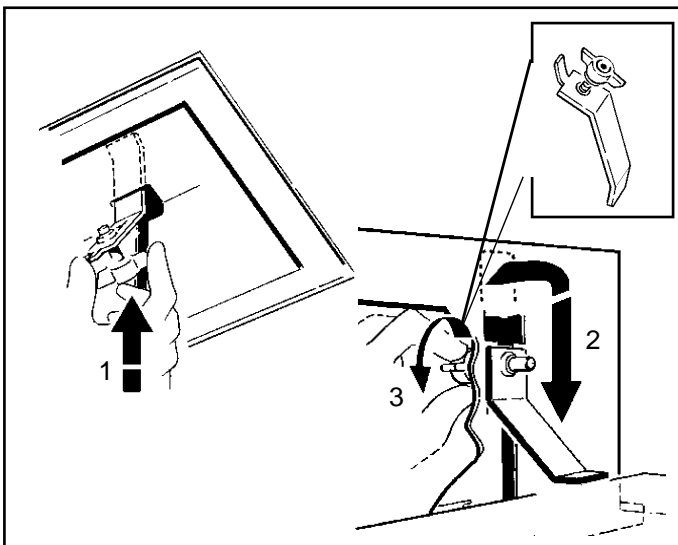

art. ML20 - ML21 - ML22 - ML23 - ML24 - ML25 - ML26 - ML27
 MP44 - MP45 - MP46 - MP47 - MP48 - MP49 - MP50 - MP51
 MP52 - MP53 - MP54 - MP55 - MP56 - MP57

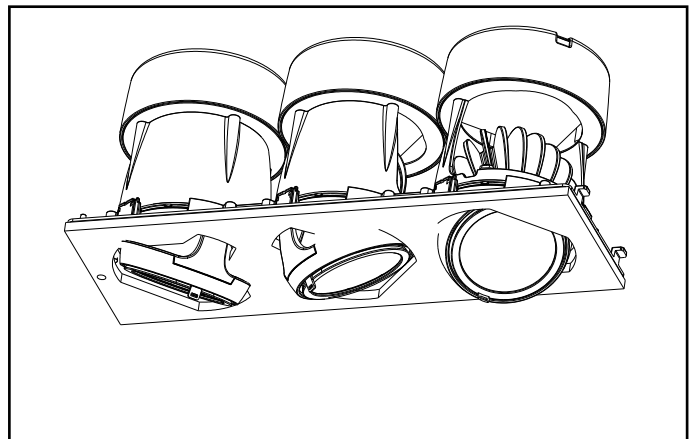
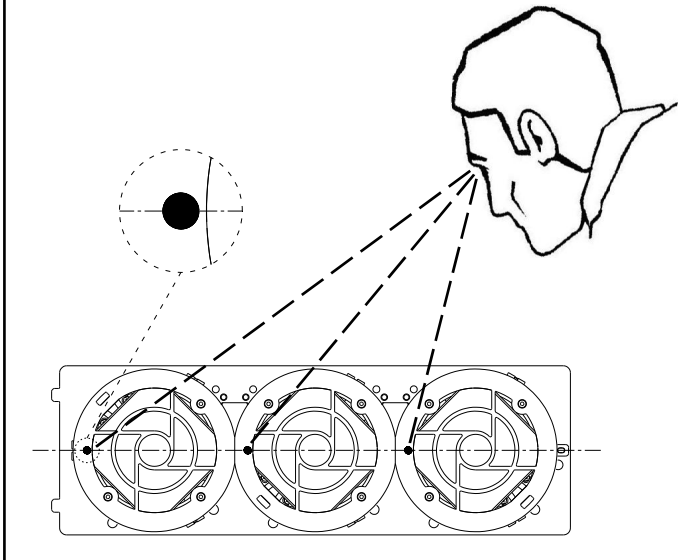

art. MF07 - MF08 - MF09 - MF10 - MF11 - MF12 - MF17 - MF18 -
 MF19 - MF20 - MF21 - MF22 - MF23 - MF24 - ML20 - ML21 - ML22
 - ML23 - ML24 - ML25 - ML26 - ML27 - MP23 - MP24 - MP25 -
 MP26 - MP27 - MP28 - MP29 - MP30 - MP31 - MP32 - MP33 -
 MP34 - MP35 - MP36 - MP44 - MP45 - MP46 - MP47 - MP48 -
 MP49 - MP50 - MP51 - MP52 - MP53 - MP54 - MP55 - MP56 -
 MP57-

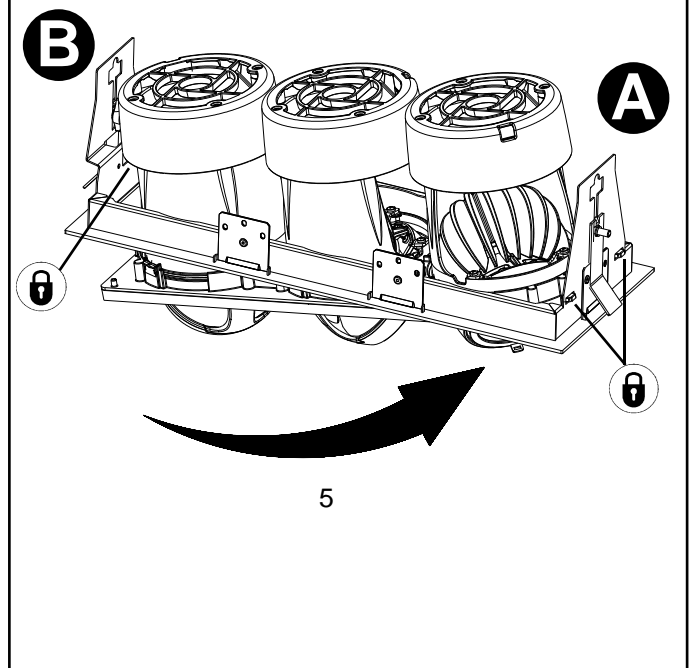
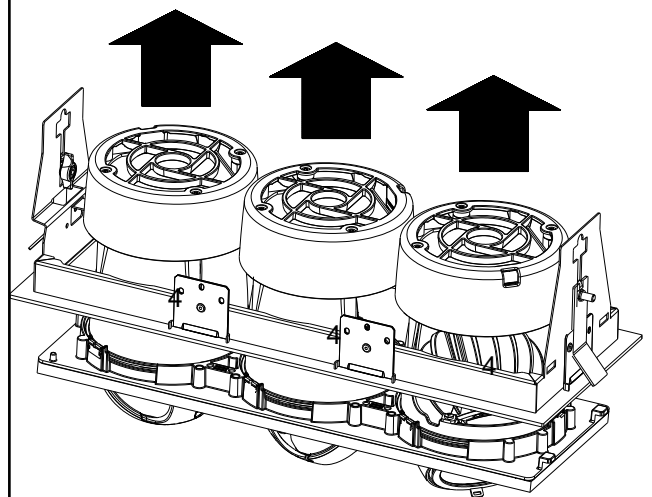

A 

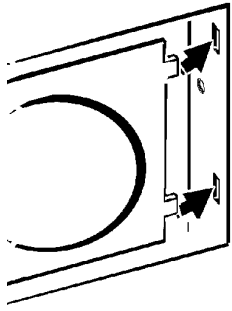

B 

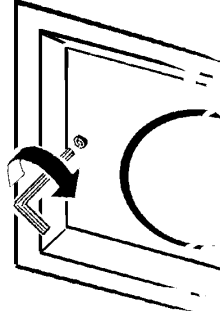

art. ML20 - ML21 - ML22 - ML23 - ML24 - ML25 - ML26 - ML27
MP44 - MP45 - MP46 - MP47 - MP48 - MP49 - MP50 - MP51
MP52 - MP53 - MP54 - MP55 - MP56 - MP57

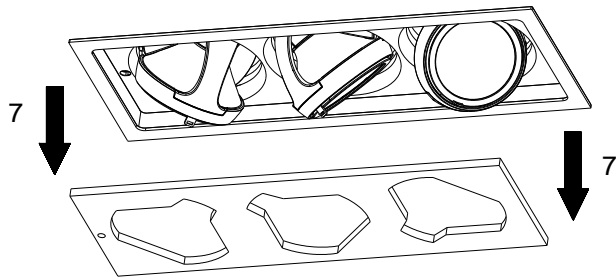
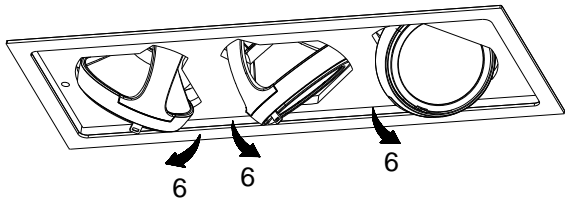

art. MF04 - MF05 - MF06 - MF13 - MF14 - MF15 - MF16 - ML16 -
ML17 - ML18 - ML19 - MP16 - MP17 - MP18 - MP19 - MP20 -
MP21 - MP22 - MP37 - MP38 - MP39 - MP40 - MP41 - MP42 -
MP43

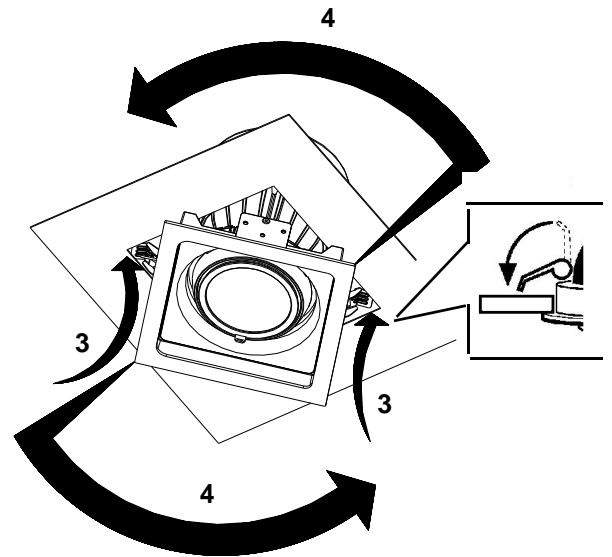
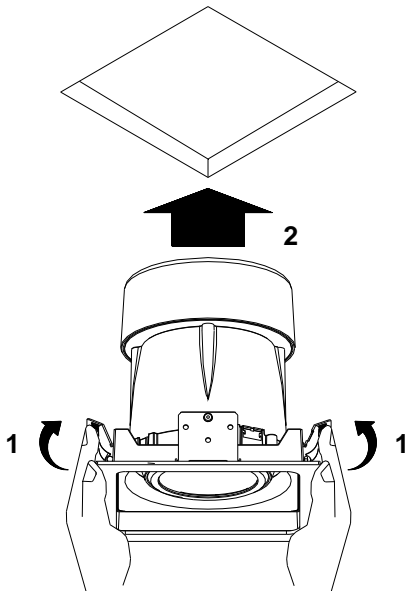

art. MF04-MF05-MF06-MF07-
MF08-MF09-MF10-MF11-MF12

OK

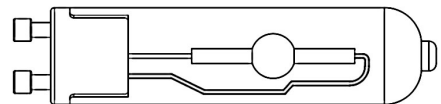



Only

GE Constant Color CMH 35W/930/GU6.5
Constant Color CMH 35W/942/GU6.5

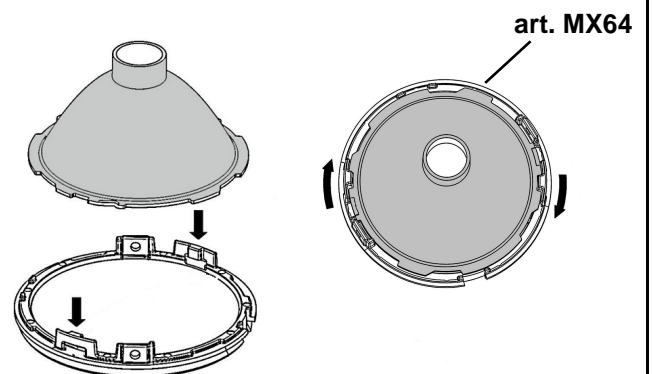
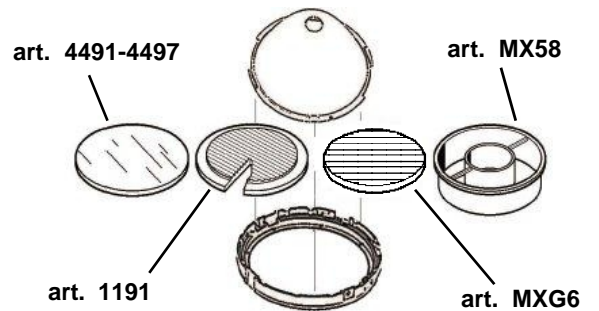
art. 4491-4497-1191-MXG6 -MX58-MX62-MX64



ART.	Filtro - Filter Filtre - Filter Filter - Filtro Filtro - Filter Filter - Filter Фильтр 濾色鏡			
	Colorato - Coloured - Couleur Farbig - Gekleurd - Colorado Färbet - Farget - Färgat - Цветной 彩色的	U.V.	art.	art.
MF04	4491	4497	1191	-
MF05	4491	4497	1191	MXG6
MF06	4491	4497	1191	MXG6
MF07	4491	4497	1191	-
MF08	4491	4497	1191	MXG6
MF09	4491	4497	1191	MXG6
MF10	4491	4497	1191	-
MF11	4491	4497	1191	MXG6
MF12	4491	4497	1191	MXG6

ART.	 art.	 art.
MF04-MF05-MF06 MF07-MF08-MF09 MF10-MF11-MF12	MX62	MX64

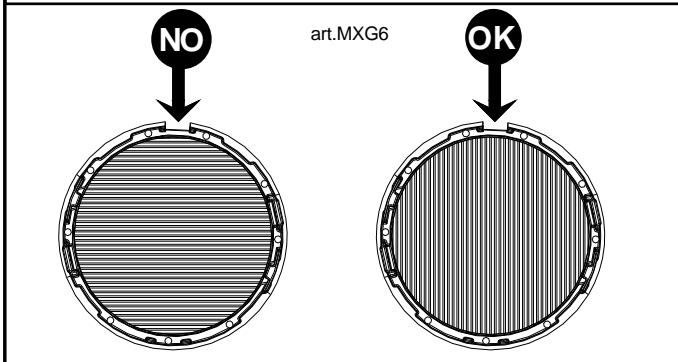
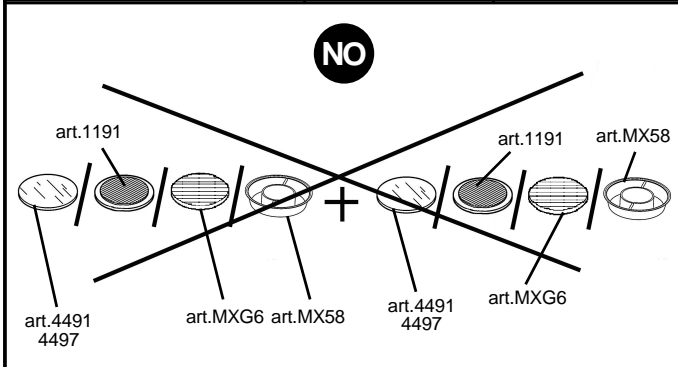

ART.	 art.
MF13-MF14-MF15-MF16-MF17 MF18-MF19-MF20-MF21-MF22 MF23-MF24-ML16-ML17-ML18 ML19-ML20-ML21-ML22-ML23 ML24-ML25-ML26-ML27	MXG6

MP16-MP17-MP18-MP19-MP20 MP21-MP22-MP23-MP24-MP25 MP26-MP27-MP28-MP29-MP30 MP31-MP32-MP33-MP34-MP35 MP36-MP37-MP38-MP39-MP40 MP41-MP42-MP43-MP44-MP45 MP46-MP47-MP48-MP49-MP50 MP51-MP52-MP53-MP54-MP55 MP56-MP57- Q199- Q200- Q201 Q202- Q203- Q204- Q205- Q206 Q207- Q208- Q209- Q210- Q211 Q212- Q213- Q214- Q215- Q216 Q217- Q218- Q219- Q220- Q221 Q222- Q223- Q224- Q225- Q226 Q227- Q228- Q229- Q230- Q231	MXG6
---	------

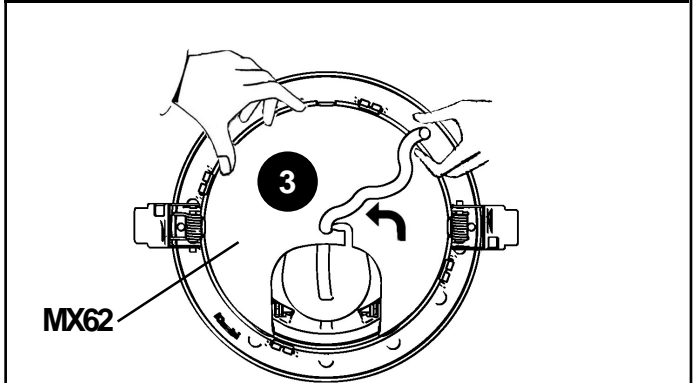
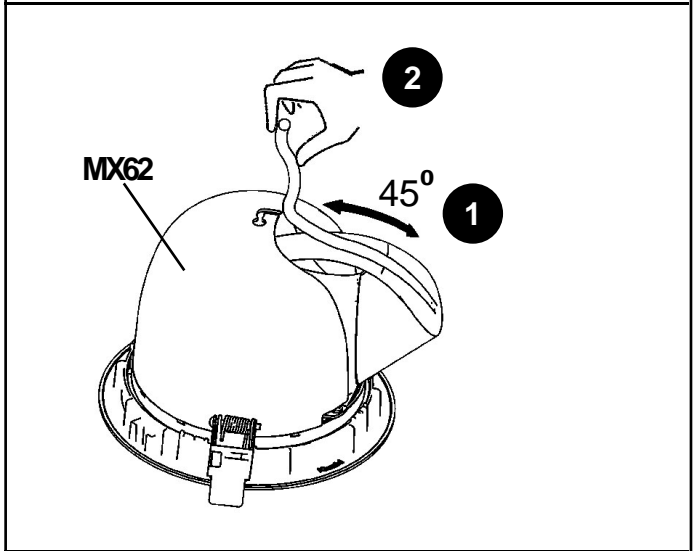
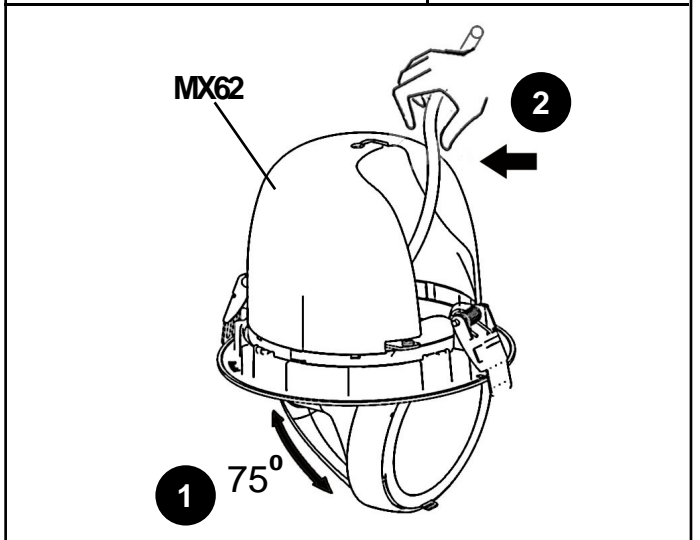

INSTALLAZIONE DEGLI ACCESSORI
INSTALLING THE ACCESSORIES
INSTALLATION DES ACCESSOIRES
INSTALLATION DER ZUBEHÖRE
INSTALLATIE VAN DE ACCESSOIRES
INSTALACIÓN DE LOS ACCESORIOS
INSTALLATION AF TILBEHØR
INSTALLERING AV TILBEHØRET
INSTALLATION AV TILLBEHÖR
МОНТАЖ ВСПОМОГАТЕЛЬНЫХ КОМПЛЕКТУЮЩИХ
配件安装

I N.B.: L'apparecchio consente l'installazione di un solo accessorio.
GB N.B.: Only one accessory can be installed on the fixture.
F N.B.: On ne peut installer qu'un accessoire sur cet appareil.
D N.B.: Das Gerät ermöglicht die Installation von nur einem Zubehörteil.
NL N.B.: De armatuur is slechts geschikt voor de installatie van één accessoire.
E NOTA: El aparato sólo puede montar un accesorio.
DK N.B.: Det er kun muligt at installere et tilbehør på armaturet.
N N.B.: Kun en tilbehørsinnretning kan installeres på lysarmaturen.
S OBS! Endast ett tillbehör kan installeras på utrustningen.
RUS ПРИМЕЧАНИЕ: Прибор допускает установку только одного вспомогательного устройства.
CN 注意: 仅能在装置上安装一个附件。

I Utilizzare lampade di potenza adeguata, in funzione dell'accessorio installato.
GB Use lamps with appropriate wattage according to the accessory installed.
F Utilisez des lampes ayant une puissance appropriée, selon le type d'accessoire installé.
D Bitte verwenden Sie Lampen angemessener Leistung, je nach installiertem Zubehör.
NL Gebruik lampen van voldoende watt, naar gelang het geïnstalleerde accessoire
E Utilizar lámparas de potencia adecuada según el accesorio instalado.
DK Brug lyskilder med passende effekt, alt efter det installerede tilbehør.
N Bruk lamper med riktig ytelse etter tilbehøret som er installert.
S Använd lampor med lämplig effekt, beroende på vilka tillbehör som finns installerade.
RUS Используйте лампы надлежащей мощности в зависимости от установленного дополнительного элемента.
CN 根据安装的附件使用功率适中的光源。

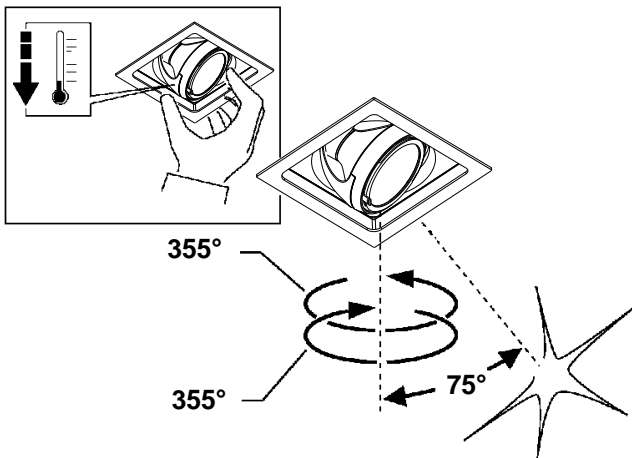
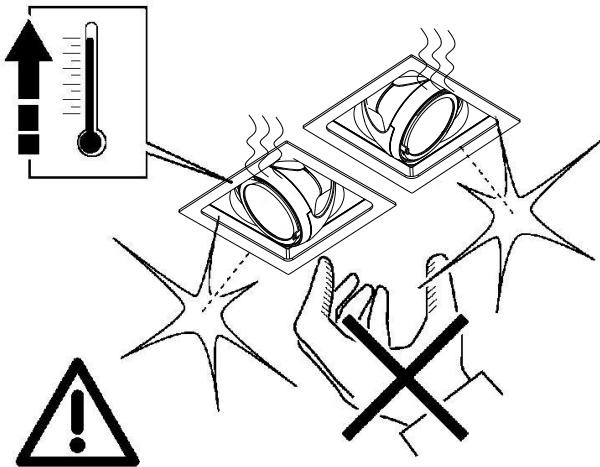
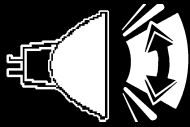

art. MF07 - MF08 - MF09 - MF10 - MF11 - MF12

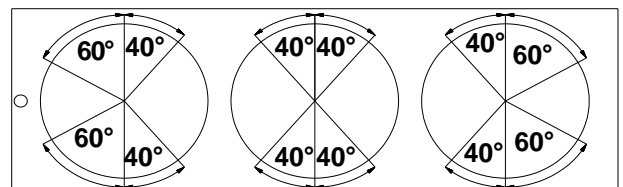
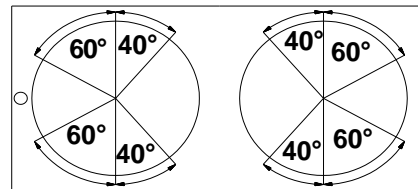
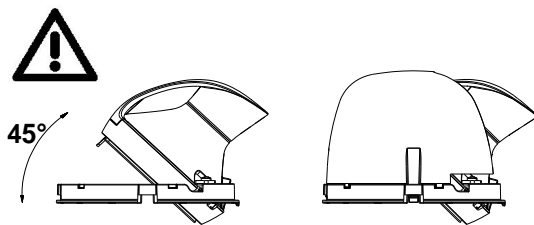
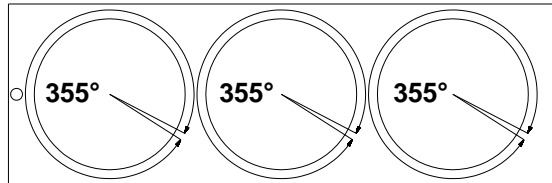
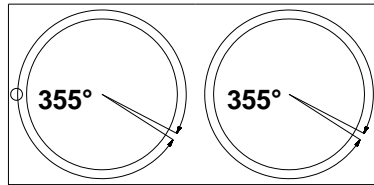
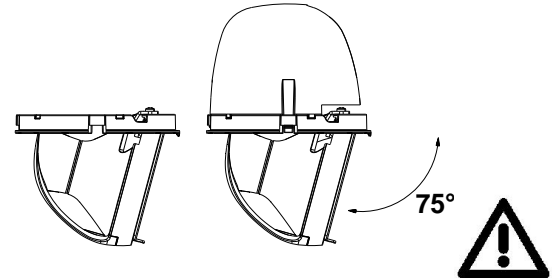
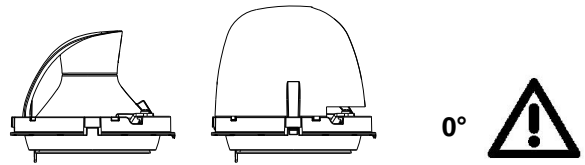

art. MF17 - MF18 - MF19 - MF20 - MF21 - MF22 - MF23 - MF24-
 ML20-ML21-ML22-ML23-ML24-ML25-ML26-ML27 -MP23-MP24-
 MP25-MP26-MP27-MP28-MP29-MP30-MP31-MP32-MP33-MP34-
 MP35-MP36-MP44-MP45-MP46-MP47-MP48-MP49-MP50-MP51-
 MP52-MP53-MP54-MP55-MP56-MP57- Q199-Q200-Q201-Q202-
 Q203-Q204-Q205-Q206-Q207-Q208-Q209-Q210-Q211-Q212-
 Q213-Q214-Q215-Q216-Q217-Q218-Q219-Q220-Q221-Q222-
 Q223-Q224-Q225-Q226-Q227-Q228-Q229-Q230-Q231

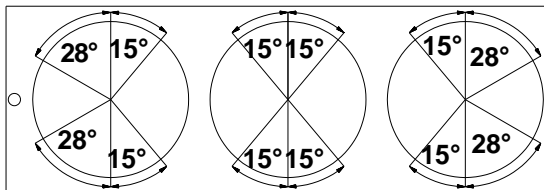
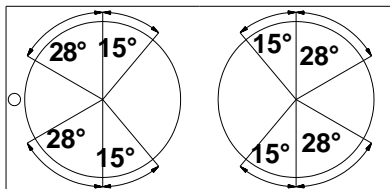
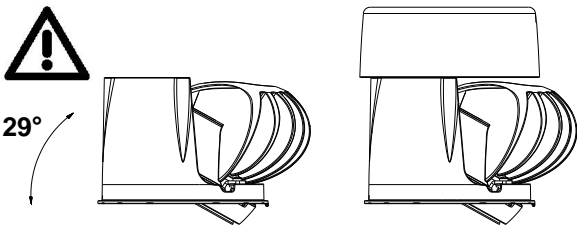
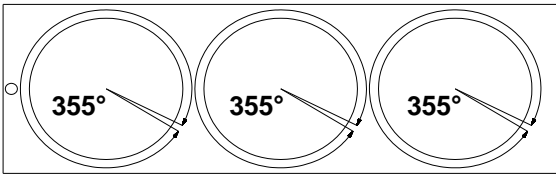
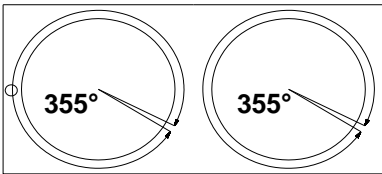
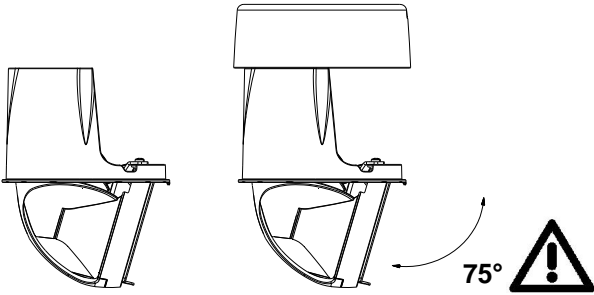
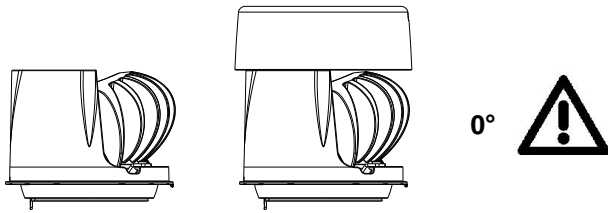

art. ML20 - ML21- ML22 - ML23 - ML24 - ML25 - ML26 - ML27
 MP44 - MP45 - MP46 - MP47 - MP48 - MP49 - MP50 - MP51
 MP52 - MP53 - MP54 - MP55 - MP56 - MP57

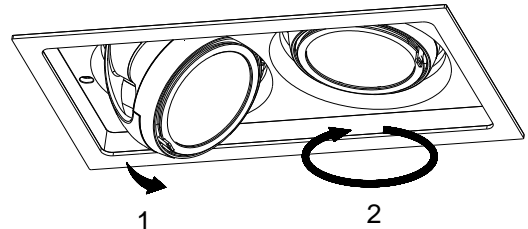
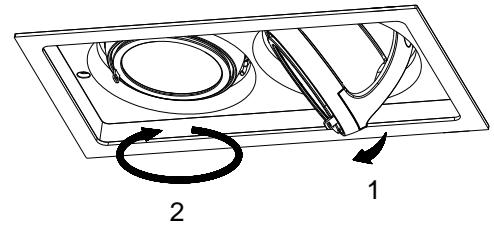
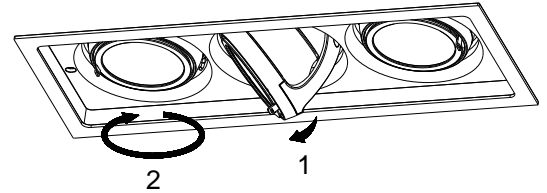
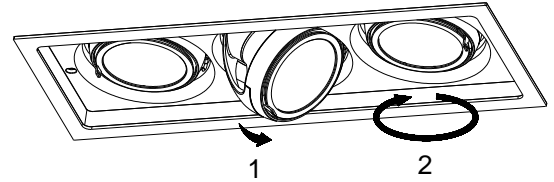
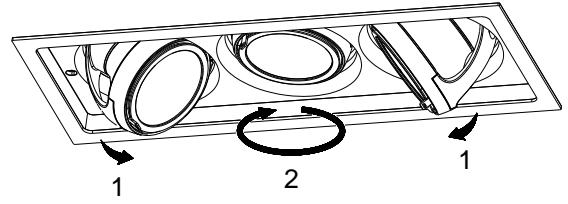

SOSTITUZIONE DEL LED
REPLACING THE LED
REPLACEMENT DE LA LED
AUSTAUSCHEN DER LED
VERVANGEN VAN DE LED
REEMPLAZO DEL LED
UDSKIFTNING AF LYSDIODE
BYTE AV LYSDIOD
UTSKIFTNING AV DEN LYSEMITTERENDE DIODEN
ЗАМЕНА СИД
发光二极管替换

I N.B.: Per la sostituzione del LED contattare l'azienda iGuzzini.

GB N.B.: For information on LED replacement please contact iGuzzini.

F N.B.: Pour procéder au remplacement de la LED, adressez-vous à la société iGuzzini.

D N.B.: Bezüglich des Austausches der LED kontaktieren Sie bitte die Firma iGuzzini.

NL N.B.: Voor het vervangen van de LED neemt u contact op met het bedrijf iGuzzini.

E NOTA: Para sustituir el LED llame a la empresa iGuzzini.

DK N.B.: For udsiftning af lysdioden, skal man kontakte iGuzzini.

N N.B.: For informasjon om skifte av LED, vennligst ta kontakt med iGuzzini.

S OBS! För byte av lysdioden, kontakta företaget iGuzzini.

RUS ПРИМЕЧАНИЕ: Для замены СИДов обращайтесь в компанию iGuzzini.

CN 注意: 如需LED更换的信息, 请联系iGuzzini.



VETRO SODICO-CALCICO TEMPRATO
TEMPERED SODA-LIME GLASS
VERRE SODIQUE-CALCIQUE TEMPRÉ
NATRIUM-KALZIUM-GLAS
GETEMPERD NATRIUMKALKGLAS
CRISTAL SÓDICO-CALCÁREO TEMPLADO
HÆRDET NATRONKALKGLAS
TEMPERERT KALK-NATRON-GLASS
HÅRDAT KALK-SODAGLAS
ЗАКАЛЕННОЕ НАТРИЕВО-КАЛЬЦИЕВОЕ СТЕКЛО
钢化钙钠玻璃

I Sostituire lo schermo di protezione danneggiato, richiedendo le specifiche tecniche al costruttore. Non utilizzare l'apparecchio senza lo schermo.

Attenzione agli oggetti deteriorabili dai raggi U.V. .

GB Replace the damaged protective screen, requesting the technical specifications from the manufacturer. Do not use the luminaire without the screen.

Be careful of the objects that deteriorate when exposed to UV rays.

F Remplacez l'écran de protection endommagé en demandant au fabricant les spécifications techniques correspondantes. N'utilisez pas l'appareil sans écran.

Attention aux objets craignant les rayons U.V.

D Ein beschädigter Schutzschirm muß ersetzt werden. Verlangen Sie vom Hersteller Angaben hinsichtlich der technischen Daten. Die Leuchte darf auf keinen Fall ohne diesen Schirm eingesetzt werden.

Vorsicht bei Artikeln, die durch UV-Strahlen beschädigt werden könnten.

NL Vervang het protectiescherm als het beschadigd is en verlang van de fabrikant de juiste technische eigenschappen. Gebruik het apparaat niet zonder het scherm.

Wees voorzichtig met voorwerpen die door de ultraviolette stralen bedorven kunnen worden.

E Sustituir la pantalla de protección dañada solicitando las respectivas especificaciones técnicas al fabricante. No utilizar el aparato sin la pantalla.

Cuidado con los objetos deteriorables por los rayos ultravioletas.

DK Udskift en beskadiget beskyttelseskærm; og spørg fabrikanten til råds vedrørende de tekniske detaljer. Brug ikke armaturet uden skærm.

Vær opmærksom på genstande, der kan nedbrydes af U.V. stråler.

N Skift ut ødelagte vermeskjermer, be om tekniske spesifikasjoner fra produsenten. Ikke bruk lysarmaturen uten skjermen.

Vær forsiktig med gjenstander som forringes ved eksponering for UV-stråler.

S Byt ut skadade skyddsskärmar. Rådfråga tillverkaren om tekniska specifikationer. Använd inte utrustningen utan skärmen.

Var försiktig med föremål som kan skadas av U.V.-strålar.

RUS Замените поврежденный защитный экран, запросив у производителя технические спецификации.

Не использовать прибор без экрана.

Обращайте внимание на предметы, которые могут быть повреждены под воздействием УФ излучения.

CN 一旦玻璃破碎后产品将不能再使用, 须联系生产商予以更换。

请勿使用无保护屏的光源。

注意那些受紫外线照射易损坏的物品。

2.519.531.04 ISK00047/04 		corrente assorbita absorbed current courant absorbé Stromaufnahme stroomopname corriente absorbida absorberet strøm absorbert strøm tillförd ström поглощаемая мощность 电源电流 (A)
ART.	fattore di potenza power factor facteur de puissance Leistungsfaktor vermogensfactor factor de potencia effektfaktor effektfaktor effektfaktor фактор мощности 功率因数	
MF13 - MF17 - MF21	> 0,87	0,077
MF14 - MF15 - MF16 MF18 - MF19 - MF20 MF22 - MF23 - MF24	> 0,88	0,079
MP16 - MP23 - MP30	> 0,96	0,068
MP17 - MP18 - MP19 MP24 - MP25 - MP26 MP31 - MP32 - MP33	> 0,96	0,07
MP20 - MP21 - MP22 MP27 - MP28 - MP29 MP34 - MP35 - MP36	> 0,97	0,082
Q199 - Q210 - Q221	> 0,95	0,113
Q200 - Q201 - Q202 Q211 - Q212 - Q213 Q222 - Q223 - Q224	> 0,95	0,116
Q203 - Q214 - Q225	> 0,96	0,108
Q204 - Q205 - Q206 Q215 - Q216 - Q217 Q226 - Q227 - Q228	> 0,96	0,111
Q207 - Q208 - Q209 Q218 - Q219 - Q220 Q229 - Q230 - Q231	> 0,96	0,107

2.519.531.04 ISK00047/04 		corrente assorbita absorbed current courant absorbé Stromaufnahme stroomopname corriente absorbida absorberet strøm absorbert strøm tillförd ström поглощаемая мощность 电源电流 (A)
ART.	fattore di potenza power factor facteur de puissance Leistungsfaktor vermogensfactor factor de potencia effektfaktor effektfaktor effektfaktor фактор мощности 功率因数	
MF13 - MF17 - MF21	> 0,87	0,077
MF14 - MF15 - MF16 MF18 - MF19 - MF20 MF22 - MF23 - MF24	> 0,88	0,079
MP16 - MP23 - MP30	> 0,96	0,068
MP17 - MP18 - MP19 MP24 - MP25 - MP26 MP31 - MP32 - MP33	> 0,96	0,07
MP20 - MP21 - MP22 MP27 - MP28 - MP29 MP34 - MP35 - MP36	> 0,97	0,082
Q199 - Q210 - Q221	> 0,95	0,113
Q200 - Q201 - Q202 Q211 - Q212 - Q213 Q222 - Q223 - Q224	> 0,95	0,116
Q203 - Q214 - Q225	> 0,96	0,108
Q204 - Q205 - Q206 Q215 - Q216 - Q217 Q226 - Q227 - Q228	> 0,96	0,111
Q207 - Q208 - Q209 Q218 - Q219 - Q220 Q229 - Q230 - Q231	> 0,96	0,107

PIXEL PRO FRAME

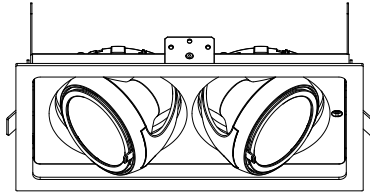

ATTENZIONE:

LA SICUREZZA DELL'APPARECCHIO E' GARANTITA SOLO CON L'USO APPROPRIATO DELLE SEGUENTI ISTRUZIONI; PERTANTO E' NECESSARIO CONSERVARLE.

WARNING:

THE SAFETY OF THIS FIXTURE IS GUARANTEED ONLY IF YOU COMPLY WITH THESE INSTRUCTIONS; REMEMBER TO CONSERVE IN A SAFE PLACE.

ATTENTION:

LA SECURITE DE L'APPAREIL N'EST GARANTIE QU'EN CAS D'UTILISATION CORRECTE DES INSTRUCTIONS SUIVANTES; IL FAUT PAR CONSEQUENT LES CONSERVER.

ACHTUNG:

DIE SICHERHEIT DES GERÄTES WIRD NUR DURCH SACHGEMÄSSE BEFOLGUNG NACHSTEHENDER ANWEISUNGEN GEWÄHRLEISTET; IHRE AUFBEWAHRUNG IST DESHALB SEHR WICHTIG.

OPGELET:

DE VEILIGHEID VAN DI ATOESTEL IS SLECHTS DAN GEGARANDEERD ALS INDIEN DE VOLGENDE INSTRUCTIES STRIKT WORDEN TOEGEPAST; DAAROM MOET MEN ZE OOK BEWAREN.

ATENCIÓN:

LA SEGURIDAD DEL APARATO SE GARANTIZA SOLO CUMPLIENDO CUIDADOSAMENTE LAS SIGUIENTES INSTRUCCIONES; POR ELLO, ES NECESARIO CONSERVARLAS.

BEMERK:

SIKKERHEDEN VED BRUG AF ARMATURET KAN KUN GARANTERES, HVIS DISSE ANVISNINGER FØLGES; SØRG DERFOR FOR AT GEMME DEM.

ADVARSEL:

SIKKERHETEN TIL DETTE APPARATET GARANTERES KUN HVIS DU OVERHOLDER DISSE INSTRUKSJONENE; HUSK Å OPPBEVARE DEM PÅ ET TRYGT STED.

OBSERVERA!

UTRUSTNINGENS SÄKERHET KAN ENDAST GARANTERAS OM DESSA ANVISNINGAR RESPEKTERAS I DETALJ. SPARA DÄRFÖR DESSA ANVISNINGAR FÖR FRAMTIDA KONSULTATION.

ВНИМАНИЕ:

МЫ ГАРАНТИРУЕМ БЕЗОПАСНУЮ ЭКСПЛУАТАЦИЮ ИЗДЕЛИЯ ТОЛЬКО П РИ СОБЛЮДЕНИИ СПЕДУЮЩИХ ИНСТРУКЦИЙ; С ЭТОЙ ЦЕЛЬЮ НЕОБХОД ИМО СОХРАНИТЬ ДАННУЮ БРОШЮРУ.

警告:

为确保该装置安全，请遵守操作指示；并于安全场所放置。

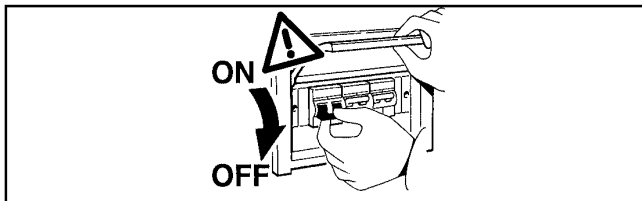

$d \dots m$

I Rispettare la distanza minima dall'oggetto illuminato, misurata lungo l'asse ottico della lampada.

GB Respect the minimum distance from the illuminated object, measured along the optical axis of the lamp.

F Respectez la distance minimum de l'objet éclairé, mesurée le long de l'axe optique de la lampe.

D Halten Sie bitte den längs zur optischen Achse der Leuchte gemessenen Mindestabstand zum beleuchteten Gegenstand ein.

NL Respecteer de minimum afstand van het verlichte object, gemeten langs de optische as van de lamp.

E Respetar la distancia mínima respecto del objeto iluminado, medida a lo largo del eje óptico de la lámpara.

DK Minimumsafstanden til det oplyste objekt skal overholdes, målt langs lyskildens optiske akse.

N Overhold minsteavstanden fra den oplyste gjenstanden, målt langs den optiske akse til lampen.

RUS Соблюдайте минимальное расстояние от освещенного объекта, измеренное вдоль оптической оси лампы.

CN 保持照明物体沿光源的光轴测量的最小距离。

HIT OK **LED NO**

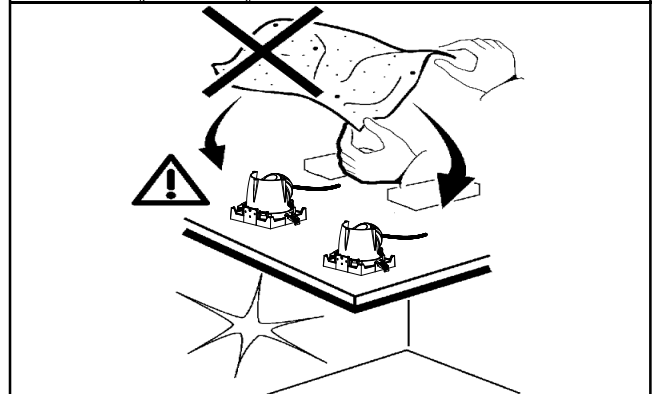
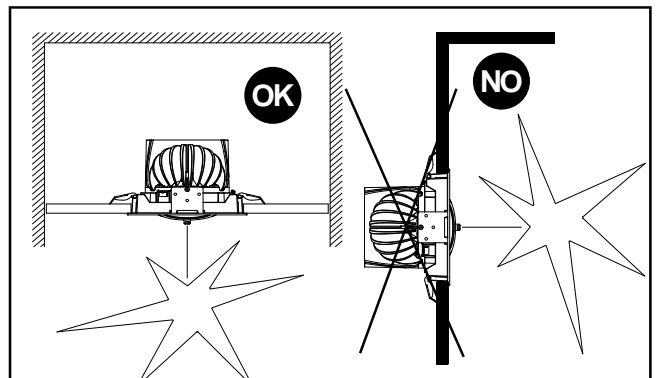
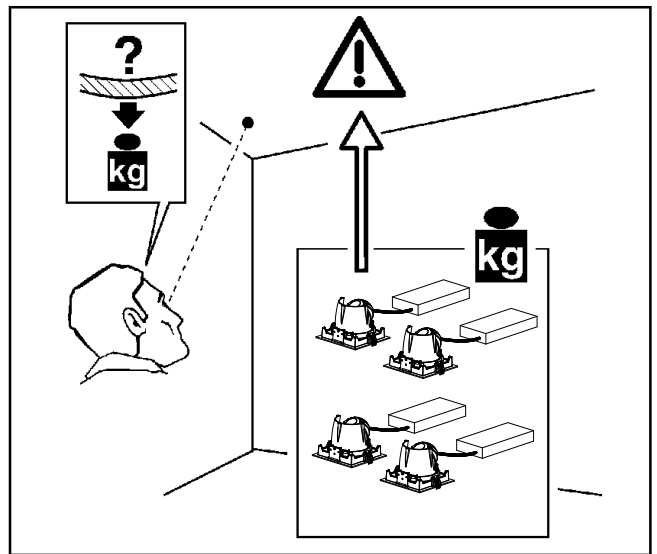
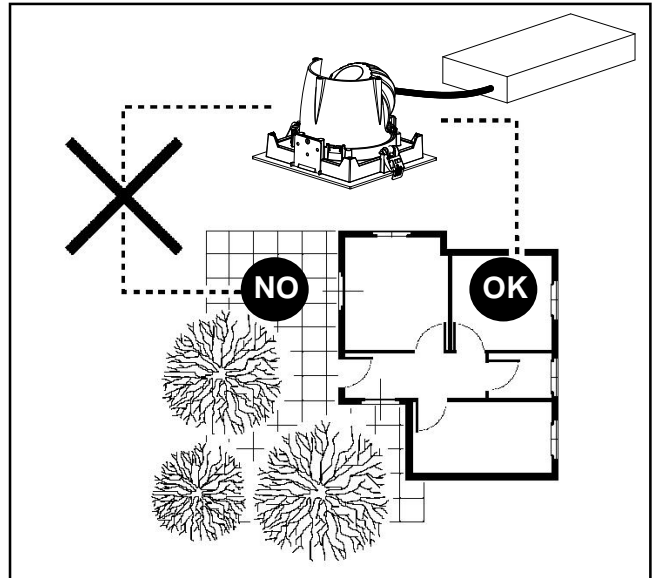

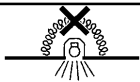

- I N.B.: L'apparecchio non deve, in alcuna circostanza, essere coperto con materiale isolante o similare.
- GB N.B.: The fixture must not be covered, under any circumstances, by insulating materials or the like.
- F N.B.: L'appareil ne doit, en aucun cas, être couvert par un matériau isolant ou autre.
- D N.B.: Das Gerät darf auf keinen Fall mit Isoliermaterial oder ähnlichem bedeckt werden.
- NL N.B.: Het apparaat mag in geen geval bedekt worden met isoleringsmateriaal of dergelijke.
- E **NOTA:** El aparato no debe ser protegido con material aislante o parecido, por ninguna causa.
- DK N.B.: Armaturet må under ingen omstændigheder tildækkes med isolerende materiale eller lignende materiale.
- N N.B.: Armaturen må ikke under noen omstendigheter tildekkes med isolerende materialer eller lignende.
- S **OBS!** Utrustningen får inte under några omständigheter täckas över med isolerande
- RUS **ПРИМЕЧАНИЕ:** Категорически запрещается покрывать прибор изоляционным или подобным материалом.
- CN **警告:** 不管在任何情况下灯具都不能被隔热材料或类似材料覆盖

art. MF04-MF05-MF06-MF07-MF08-MF09-MF10-MF11-MF12-MF13-MF14-MF15-MF16-MF17-MF18-MF19-MF20-MF21-MF22-MF23-MF24-ML16-ML17-ML18-ML19-ML20-ML21-ML22-ML23-ML24-ML25-ML26-ML27-MP16-MP17-MP18-MP19-MP20-MP21-MP22-MP23-MP24-MP25-MP26-MP27-MP28-MP29-MP30-MP31-MP32-MP33-MP34-MP35-MP36-MP37-MP38-MP39-MP40-MF41-MP42-MP43-MP44-MP45-MP46-MP47-MP49-MP50-MP51-MP52-MP53-MP54-MP55-MP56-MP57-Q199-Q200-Q201-Q202-Q203-Q204-Q205-Q206-Q207- Q208-Q209-Q210-Q211-Q212-Q213-Q214-Q215-Q216-Q217- Q218-Q219-Q220-Q221-Q222-Q223-Q224-Q225-Q226-Q227- Q228-Q229-Q230-Q231

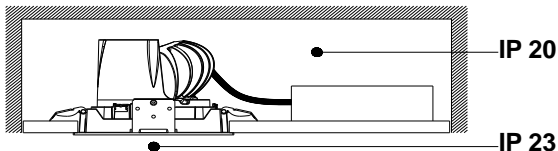

- I **Installando il prodotto a plafone in un vano chiuso, il grado di protezione è quello indicato in figura.**
- GB **If you install the product on the ceiling in a closed room, the degree of protection is that indicated in the figure.**
- F **En cas d'installation du produit au plafond dans une niche fermée, l'indice de protection est celui qui est indiqué sur la figure.**
- D **Wenn Sie das Deckenmodell in einem geschlossenen Raum installieren, so entspricht der Schutzgrad den Werten in der Abbildung.**
- NL **Bij installatie aan het plafond in een gesloten ruimte is de protectiegraad zoals aangegeven in de afbeelding.**
- E **Instalando el producto como plafón en un compartimento cerrado, el grado de protección es el que se indica en la figura.**
- DK **Hvis produktet monteres i loftet i et lukket rum, er beskyttelsesgraden som vist i figuren.**
- N **Hvis du installerer produktet på taket i et lukket rom, er beskyttelsesgraden den som er indikert på figuren.**
- S **Genom att installera innetaksbelysningen i ett stängt rum, är skyddsgraden densamma som anges i figuren.**
- RUS **При монтаже плафонного прибора в закрытом отсеке класс электробезопасности будет таким, как указано на схеме.**
- CN **如要将产品安装在密闭房间的天花板上, 保护等级如表中所示.**

art. MF04 - MF05 - MF06 - MF07 - MF08 - MF09 - MF10 - MF11 - MF12

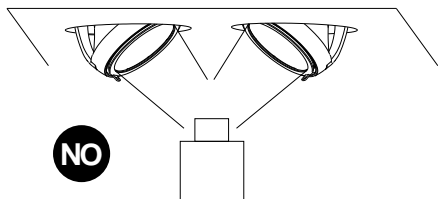

500 X 500 X 150
H=150mm

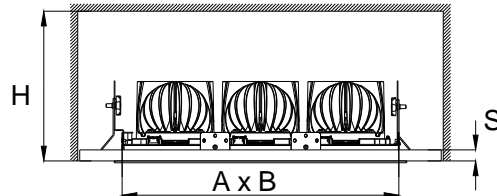
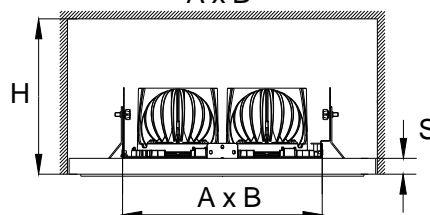
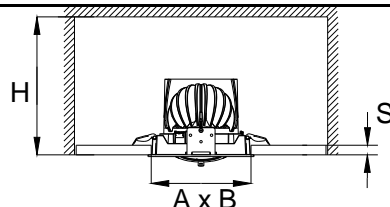
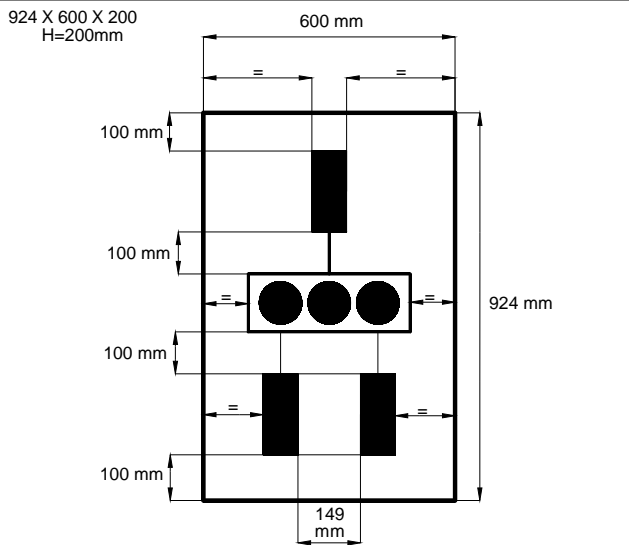
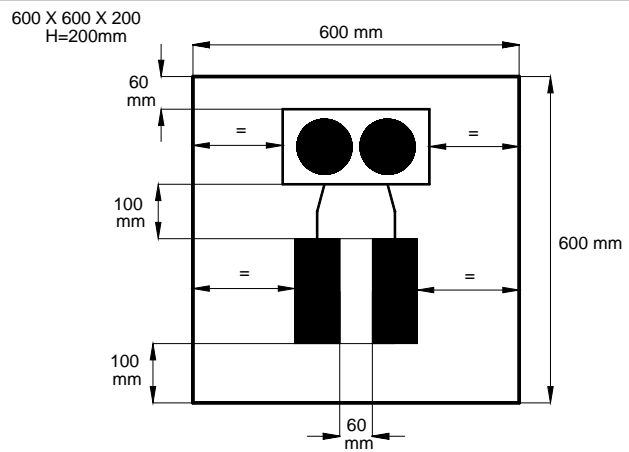
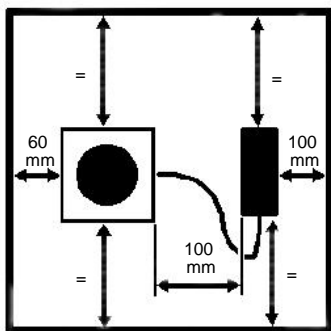

- I Consultare la seguente tabella e praticare il foro sul controsoffitto.
- GB Consult following table and make hole on ceiling.
- F Consulter le tableau suivant et percer un trou dans le faux-plafond.
- D Nachstehende Tabelle zu Rate ziehen und ein Loch in der Hängedecke bohren.
- NL Raadpleeg de volgende tabel en maak het gat in het verlaagde plafond.
- E Consultar el cuadro siguiente antes de taladrar los orificios en el falso techo.
- DK Der henvises til følgende tabel ved boring af huller i det forsænkede loft.
- N Se følgende tabell og bore hull i himlingen.
- S Se följande tabell och borra hålet i taket.
- RUS Смотрите таблицу ниже для расчета проема в фальш-потолке.
- CN 参考下面的图表, 在天花板上打孔.

ART.	mm			
	H min	S	A	B
MF04-MF05-MF06 MF13-MF14-MF15 MF16-ML16-ML17 ML18-ML19-MP16 MP17-MP18-MP19 MP20-MP21-MP22 MP37-MP38-MP39 MP40-MP41-MP42 MP43- Q199- Q200 Q201- Q202- Q203 Q204- Q205- Q206 Q207- Q208- Q209	150	1÷20	142	142
MF07-MF08-MF09 MF17-MF18-MF19 MF20-ML20-ML21 ML22-ML23-MP23 MP24-MP25-MP26 MP27-MP28-MP29 MP44-MP45-MP46 MP47-MP48-MP49 MP50- Q210- Q211 Q212- Q213- Q214 Q215- Q216- Q217 Q218- Q219- Q220	200	1÷20	270	138
MF10-MF11-MF12 MF21-MF22-MF23 MF24-ML24-ML25 ML26-ML27-MP30 MP31-MP32-MP33 MP34-MP35-MP36 MP51-MP52-MP53 MP54-MP55-MP56 MP57- Q221- Q222 Q223- Q224- Q225 Q226- Q227- Q228 Q229- Q230- Q231	200	1÷20	386	138

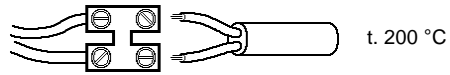
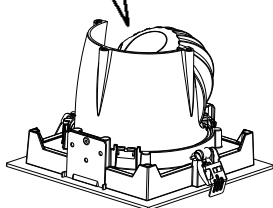
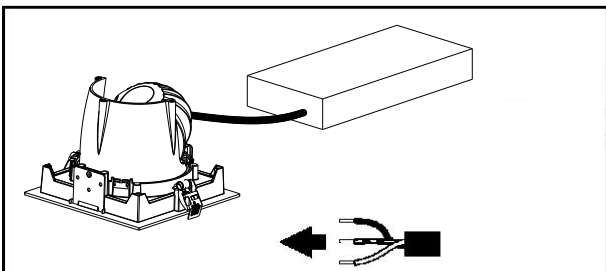
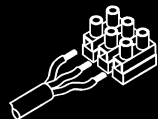

- I Per il cablaggio elettrico utilizzare cavi con doppio isolamento.
N.B.: Utilizzare per il collegamento alla rete cavi resistenti alle alte temperature.
- GB For the electrical wiring use cables with double insulation.
N.B.: For connection to the main, use cables which are resistant to high temperatures.
- F Pour le câblage électrique, utiliser des câbles à double isolation.
N.B.: Pour le raccordement au réseau, utilisez des câbles résistants à de hautes températures.
- D Für die elektrische Verdrahtung sind Kabel mit Mantel zu verwenden.
N.B.: Für den Netzanschluß hitzebeständige Kabel verwenden.
- NL Gebruik dubbel-geïsoleerde kabels voor de elektrische aansluiting.
N.B.: Voor aansluiting aan het net moet men hittebestendige kabels gebruiken.
- E Para el cableado eléctrico servirse de cables con doble aislamiento.
NOTA: Para la conexión a la red, utilizar cables de resistencia elevada a temperaturas.
- DK De anvendte ledninger skal have dobbelt isolering.
N.B.: Brug ledninger, der kan tåle høje temperaturer, ved tilslutning til forsyningsnettet.
- N For elektrisk kabling, bruk kabler med dobbel isolering.
N.B.: For tilkopling til strømmettet, bruk kabler som er motstandsdyktige mot høye temperaturer.
- RUS Для монтажа кабелепроводки используйте провода с двойной изоляцией.
ПРИМЕЧАНИЕ: Для подсоединения к сети используйте кабели, устойчивые к высокой температуре.
- CN 连接电线请用双隔离电缆。
注意: 为与干线连接, 使用耐高温电缆。

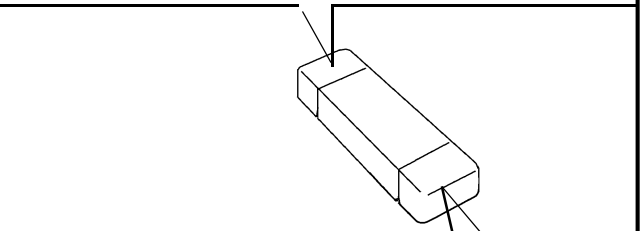
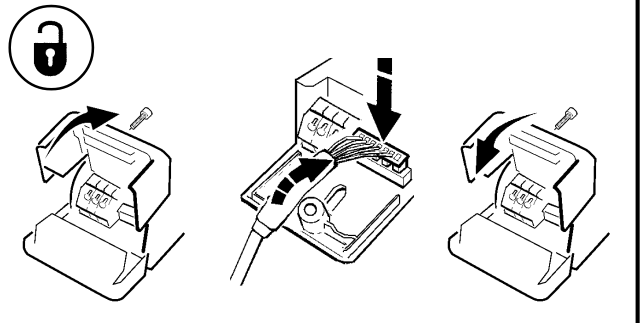

ALIMENTAZIONE
POWER SUPPLY
ALIMENTATION
EINSPEISUNG
STROOMVERZORGING
ALIMENTACION
STRØMFORSYNING
STRØMFORSYNING
ELFÖRSÖRJNING
ЭЛЕКТРОПИТАНИЕ
电源

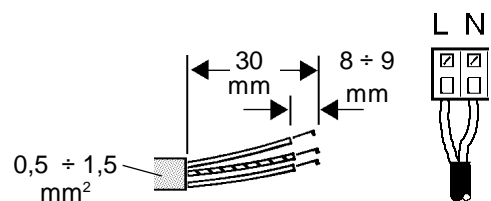
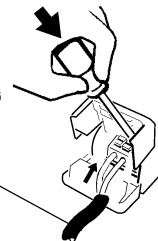

DALI

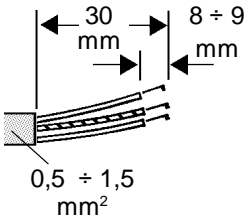
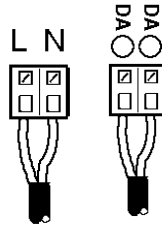
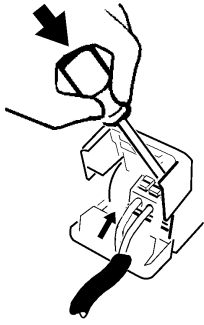

ALIMENTAZIONE
POWER SUPPLY
ALIMENTATION
EINSPEISUNG
STROOMVERZORGING
ALIMENTACION
STRØMFORSYNING
STRØMFORSYNING
ELFØRSØRNING
ЭЛЕКТРОПИТАНИЕ
电源

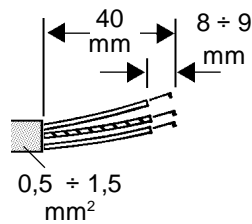

LINEA PER DIMMERAZIONE (DALI)
LINE FOR DIMMING (DALI)
LIGNE POUR GRADATION (DALI)
PRODUKTLINIE ZUR DIMMUNG (DALI)
LIJN VOOR DIMMER (DALIA)
LINEA PARA REGULACION INTENSIDAD LUMINOSA (DALI)
KREDS TIL DÆMPNING (DALI)
DIMMERLINJE (DALI)
DIMMERLINJE (DALI)
ЛИНИЯ ДЛЯ РЕГУЛЯЦИИ МОЩНОСТИ СВЕТА ЛАМПЫ (DALI)
调光线 (DALI)

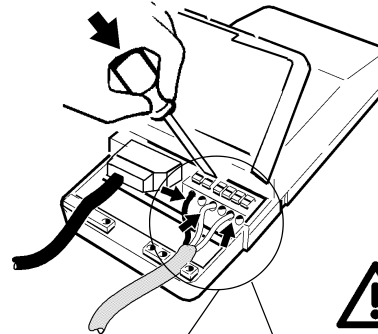
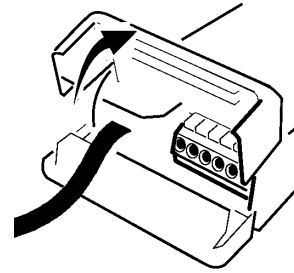

ALIMENTAZIONE
POWER SUPPLY
ALIMENTATION
EINSPEISUNG
STROOMVERZORGING
ALIMENTACION
STRØMFORSYNING
STRØMFORSYNING
ELFØRSØRNING
ЭЛЕКТРОПИТАНИЕ
电源

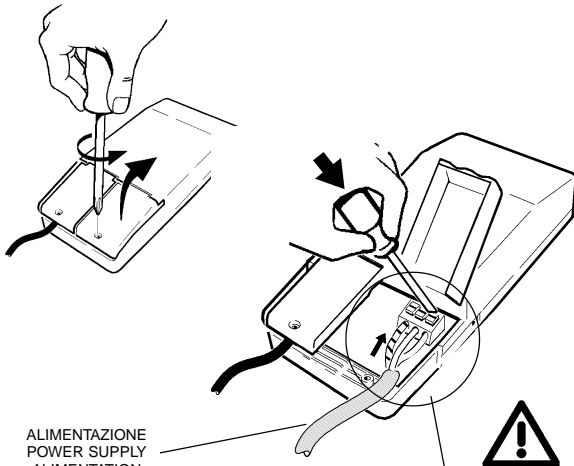

ALIMENTAZIONE
POWER SUPPLY
ALIMENTATION
EINSPEISUNG
STROOMVERZORGING
ALIMENTACION
STRØMFORSYNING
STRØMFORSYNING
ELFØRSØRNING
ЭЛЕКТРОПИТАНИЕ
电源

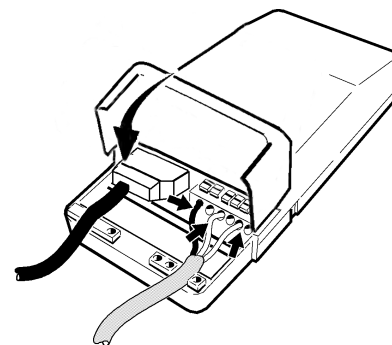
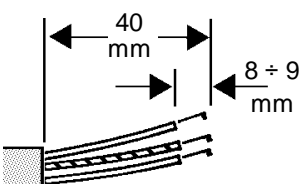
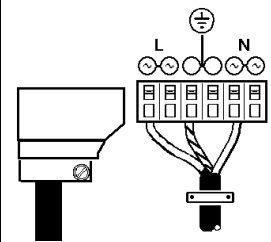
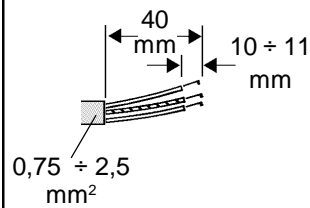

DALI

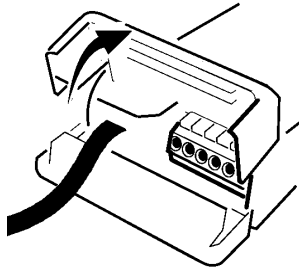

ALIMENTAZIONE
POWER SUPPLY
ALIMENTATION
EINSPEISUNG
STROOMVERZORGING
ALIMENTACION
STRØMFORSYNING
STRØMFORSYNING
ELFØRSØRNING
ЭЛЕКТРОПИТАНИЕ
电源

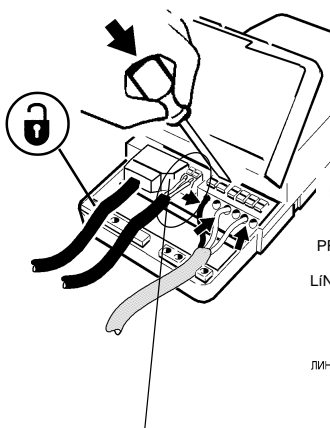
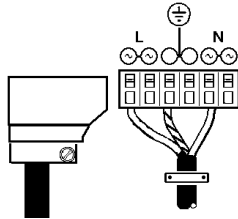
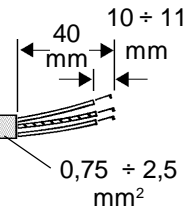

LINEA PER DIMMERAZIONE(DALI)
LINE FOR DIMMING(DALI)
LIGNE POUR GRADATION(DALI)
PRODUKTLINJE ZUR DIMMUNG(DALI)
LIJN VOOR DIMMER(DALIA)
LINEA PARA REGULACIÓN INTENSIDAD LUMINOSA(DALI)
KREDS TIL DÆMPNING(DALI)
DIMMERLINJE(DALI)
DIMMERLINJE(DALI)
ЛИНИЯ ДЛЯ РЕГУЛЯЦИИ МОЩНОСТИ СВЕТА ЛАМПЫ(DALI)
调光线 (DALI)

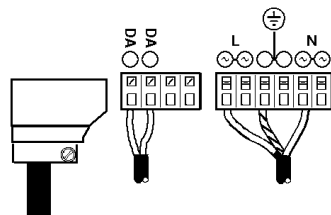
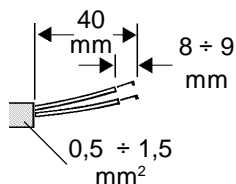

DALI

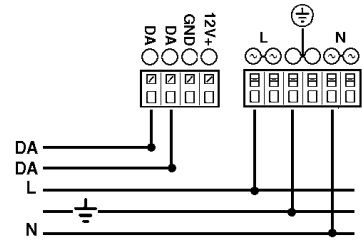

TOUCH DIM

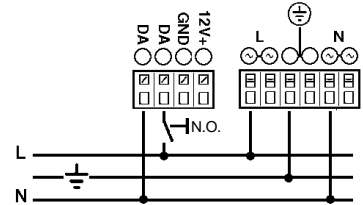

- I I dispositivi con cablaggio digitale possono essere dimmerati con dispositivi DALI o con pulsante normalmente aperto (N.O.) da collegare come da schema.
- GB Devices with digital control gear may be dimmed using DALI devices or a normally-open button (N.O.) to be connected as shown in the diagram.
- F Les articles à câblage numérique peuvent fonctionner avec des variateurs à dispositifs DALI ou à bouton poussoir normalement ouvert (N.O.) à relier conformément au schéma.
- D Die Geräte mit digitaler Verkabelung können mit Hilfe von DALI-Vorrichtungen oder mit Hilfe eines gemäß Schaltplan anzuschließenden Schließers (N.O.) gedimmt werden.
- NL De producten met digitale bekabeling kunnen worden gedimd met DALI systemen of met een N.O. (normally open) knop, die moet worden aangesloten volgens schema.
- E Los dispositivos con cableado digital pueden regularse con dispositivos DALI o con un interruptor de botón normalmente abierto (N.O.) que se conecta según ilustrado en el esquema.
- DK Produkter med digital kabelføring kan dæmpes med DALI-anordninger eller med kontakten, som normalt er åben (N.O.) og som skal tilsluttes, som vist.
- N Produkter med digitalkabler kan dimmes med DALI-anordninger eller med en normalt åpen (NO) trykkbryter som kobles som vist i koblingsskjema.
- S Produkter med digital kabeldragning kan föräms med dimmer. Detta kan göras med DALI-anordningarna eller med en normalt öppen kontakt (N.O.) som ska anslutas enligt schemat.
- RUS Интенсивность приборов с цифровой проводкой может регулироваться посредством устройств DALI или нормально разомкнутой кнопкой (Н.П.), подсоединяемой согласно схеме.
- CN 带有数字控制装置的设备可以通过 DALI (数字化可寻址调光接口) 设备或者一个连接方式如图中所示的常开按钮 (N.O.) 进行亮度调节

- I Pilotare diversi prodotti DALI tramite pulsante (es: Touch-dim, Switch-dim, Push-dim, Direct-dim, etc.) potrebbe causare dei problemi di sincronizzazione tra gli stessi. È possibile ovviare a questo problema dotandosi di dispositivi aggiuntivi. Per maggiori informazioni vi invitiamo a contattarci direttamente.
- GB Controlling different DALI products through buttons (e.g.: Touch-dim, Switch-dim, Push-dim, Direct-dim, etc.) may lead to product synchronisation problems. This problem can be overcome by using additional devices. For further information, please contact us directly.
- F Piloter plusieurs produits DALI par bouton (ex : Touch-dim, Switch-dim, Push-dim, Direct-dim, etc.) pourrait causer des problèmes de synchronisation entre eux. Ce problème peut être évité en s'équipant de dispositifs supplémentaires. Pour de plus amples renseignements, veuillez nous contacter directement.
- D Die Steuerung verschiedener DALI-Produkte mittels Taste (z.B.: Touch-dim, Switch-dim, Push-dim, Direct-dim etc.) kann eventuell zu Synchronisierungsproblemen zwischen diesen führen. Dieses Problem lässt sich durch den Einsatz von zusätzlichen Geräten beheben. Wenn Sie weitere Informationen wünschen, setzen Sie sich bitte direkt mit uns in Verbindung.
- NL Het besturen van verschillende DALI producten m.b.v. dezelfde knop (bv.: Touch-dim, Switch-dim, Push-dim, Direct-dim, etc.) kan synchronisatieproblemen tussen de producten opleveren. Men kan dit probleem voorkomen door extra systemen aan te sluiten. Voor verdere informatie raden we u aan direct contact met ons op te nemen.
- E El mando de varios productos DALI por tecla (ej: Touch-dim, Switch-dim, Push-dim, Direct-dim, etc.) podría causar problemas de sincronización entre ellos. Es posible prevenir este problema utilizando dispositivos adicionales. Para más información, contacte directamente con nosotros.
- DK Hvis DALI-produkterne styres ved hjælp af knapperne (fx. Touch-dim, Switch-dim, Push-dim, Direct-dim osv.), kan det skabe problemer med synkronisering af samme. Dette problem kan undgås, hvis man køber ekstra enheder. For yderligere oplysninger, kontakt os direkte.
- N Å styre ulike DALI-produkter ved hjelp av en trykknappbryter (f.eks. touch-dim, switch-dim, push-dim, direct-dim, osv.) vil kunne føre til problemer med synkroniseringen mellom dem. Dette problemet kan løses ved hjelp av noen tilleggsinnretninger. Ta gjerne kontakt med oss for mer informasjon om dette.
- S Styrning av olika DALI-produkter med knapp (t.ex.: Touch-dim, Switch-dim, Push-dim, Direct-dim o.s.v.) kan orsaka synkroniseringsproblem mellan dessa. Detta problem kan åtgärdas med tillägsanordningar. För mer information kan du kontakta oss direkt.
- RUS Управление различными продуктами DALI с помощью кнопки (напр.: Touch-dim, Switch-dim, Push-dim, Direct-dim и пр.) может вызвать проблемы синхронизации между ними. Эту проблему можно устранить путем задействования дополнительных устройств. За получением более подробной информации просим Вас связаться с нами непосредственно.
- CN 通过按钮控制不同的 DALI 产品 (例如: 触摸调光、切换调光、按钮调光、直接调光等) 可能会导致产品的同步问题。该问题可通过使用其他额外的装置加以克服。如需了解更多信息, 请直接与我们联系。

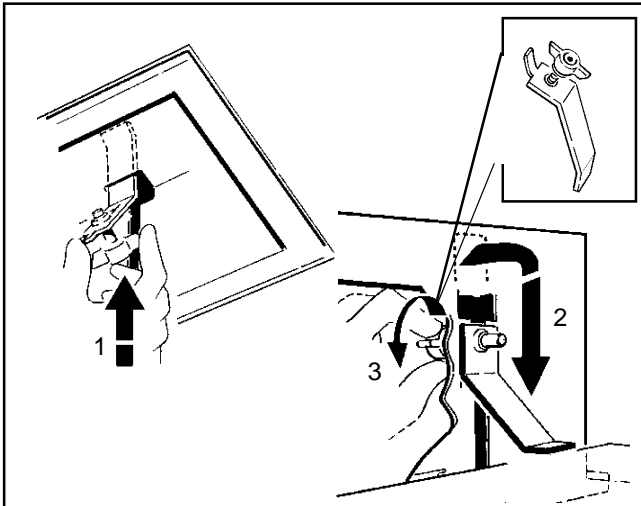
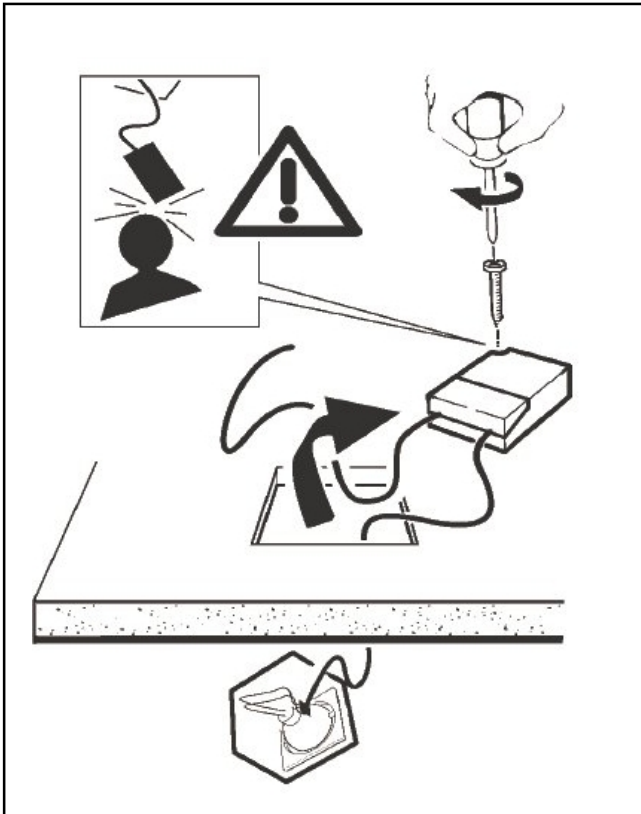

art. ML20 - ML21 - ML22 - ML23 - ML24 - ML25 - ML26 - ML27
 MP44 - MP45 - MP46 - MP47 - MP48 - MP49 - MP50 - MP51
 MP52 - MP53 - MP54 - MP55 - MP56 - MP57

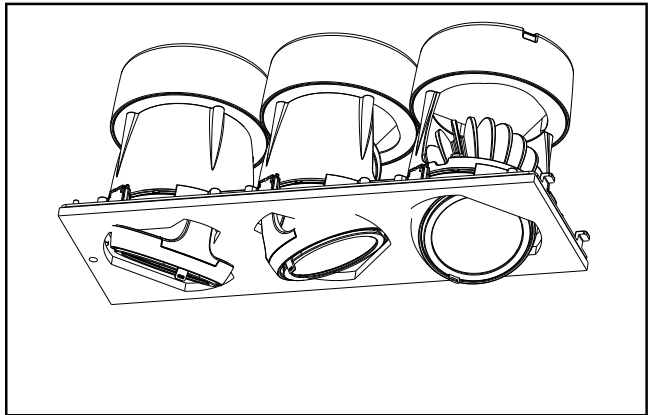
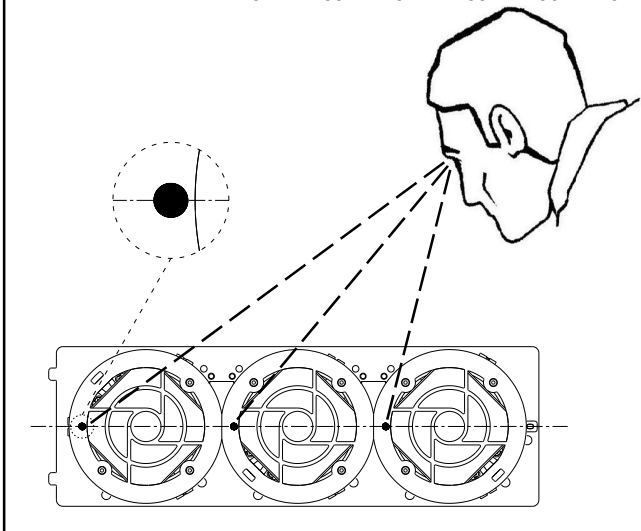

art. MF07 - MF08 - MF09 - MF10 - MF11 - MF12 - MF17 - MF18 -
 MF19 - MF20 - MF21 - MF22 - MF23 - MF24 - ML20 - ML21 - ML22
 - ML23 - ML24 - ML25 - ML26 - ML27 - MP23 - MP24 - MP25 -
 MP26 - MP27 - MP28 - MP29 - MP30 - MP31 - MP32 - MP33 -
 MP34 - MP35 - MP36 - MP44 - MP45 - MP46 - MP47 - MP48 -
 MP49 - MP50 - MP51 - MP52 - MP53 - MP54 - MP55 - MP56 -
 MP57-

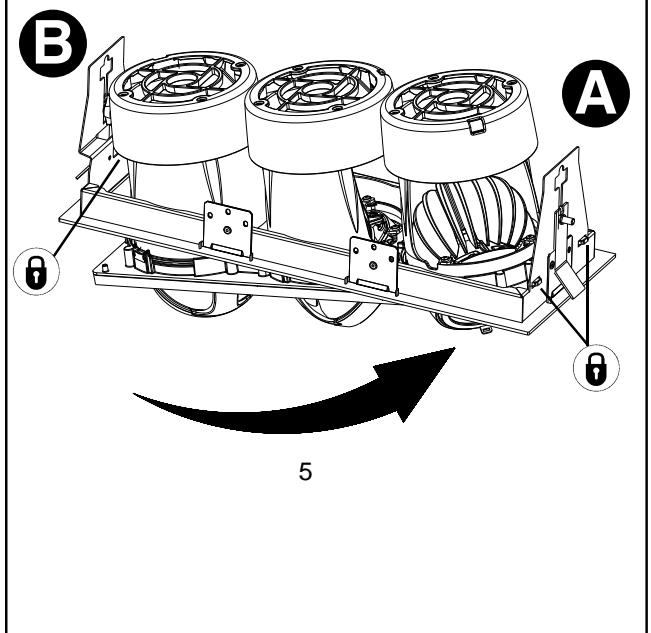
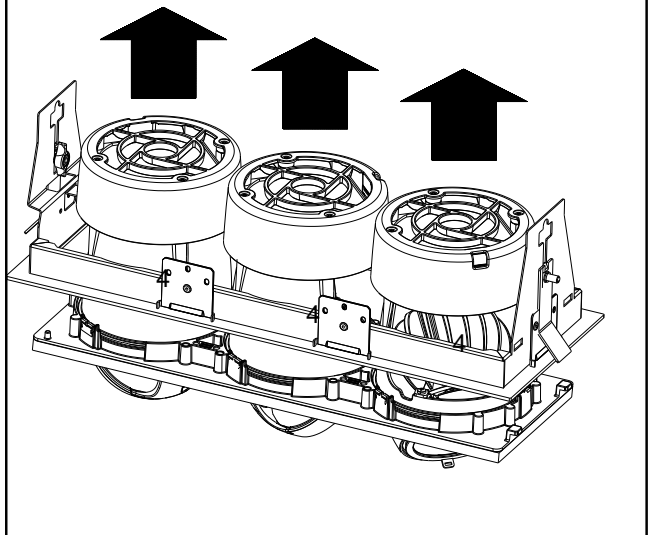

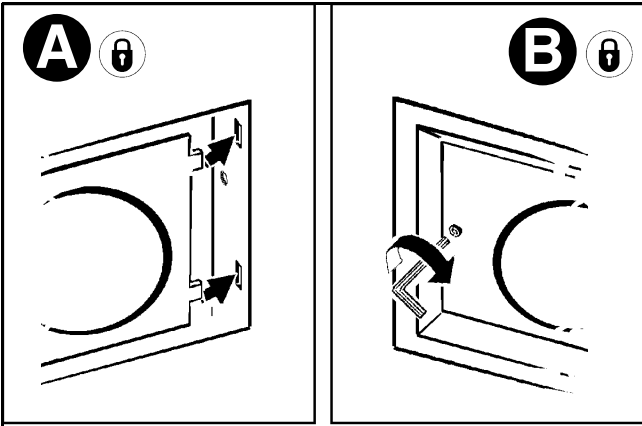

art. ML20 - ML21 - ML22 - ML23 - ML24 - ML25 - ML26 - ML27
 MP44 - MP45 - MP46 - MP47 - MP48 - MP49 - MP50 - MP51
 MP52 - MP53 - MP54 - MP55 - MP56 - MP57

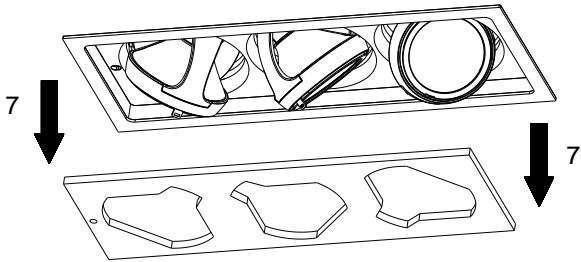
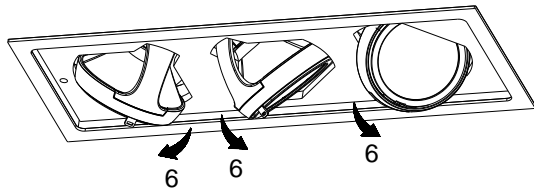

art. MF04 - MF05 - MF06 - MF13 - MF14 - MF15 - MF16 - ML16 -
 ML17 - ML18 - ML19 - MP16 - MP17 - MP18 - MP19 - MP20 -
 MP21 - MP22 - MP37 - MP38 - MP39 - MP40 - MP41 - MP42 -
 MP43

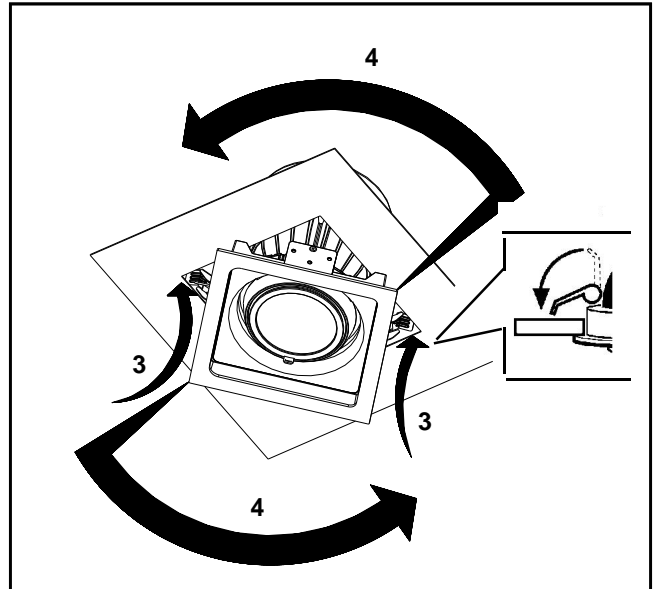
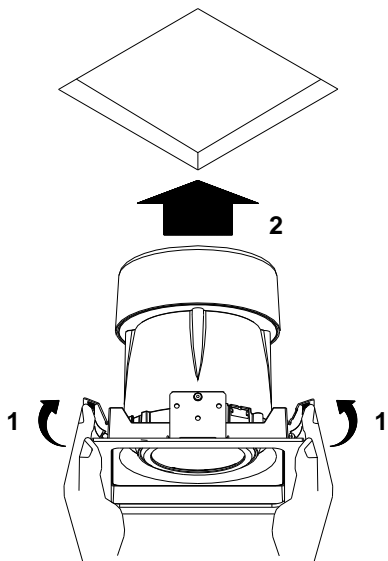

art. MF04-MF05-MF06-MF07-
 MF08-MF09-MF10-MF11-MF12

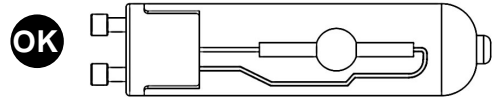



Only

GE Constant Color CMH 35W/930/GU6.5
 Constant Color CMH 35W/942/GU6.5

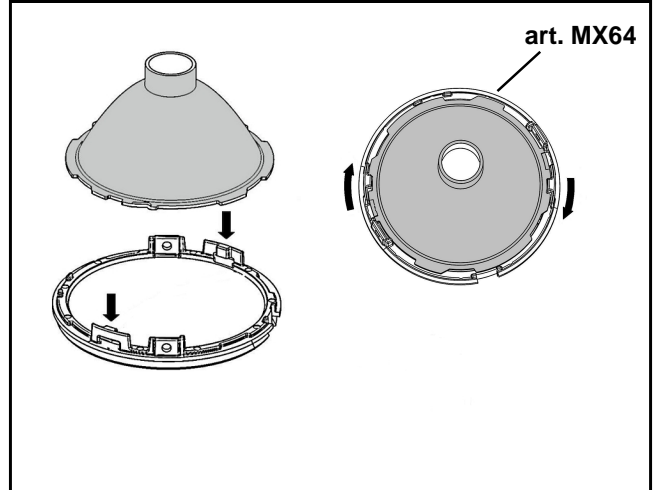
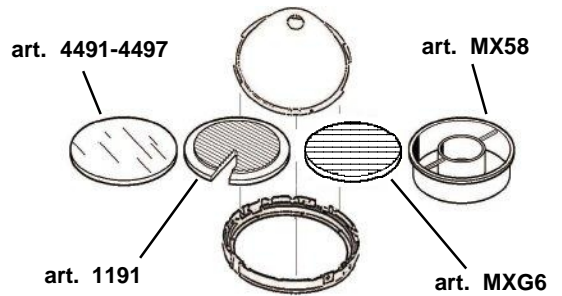
art. 4491-4497-1191-MXG6 -MX58-MX62-MX64



ART.	Filtro - Filter Filtre - Filter Filter - Filtro Filtro - Filter Filter - Filter Фильтр 濾色鏡				
	Colorato - Coloured - Couleur Farbig - Gekleurd - Colorado Favret - Farget - Färgat - Цветной 彩色的	U.V.	art.	art.	art.
MF04	4491	4497	1191	-	MX58
MF05	4491	4497	1191	MXG6	MX58
MF06	4491	4497	1191	MXG6	MX58
MF07	4491	4497	1191	-	MX58
MF08	4491	4497	1191	MXG6	MX58
MF09	4491	4497	1191	MXG6	MX58
MF10	4491	4497	1191	-	MX58
MF11	4491	4497	1191	MXG6	MX58
MF12	4491	4497	1191	MXG6	MX58

ART.	 art.	 art.
MF04-MF05-MF06 MF07-MF08-MF09 MF10-MF11-MF12	MX62	MX64

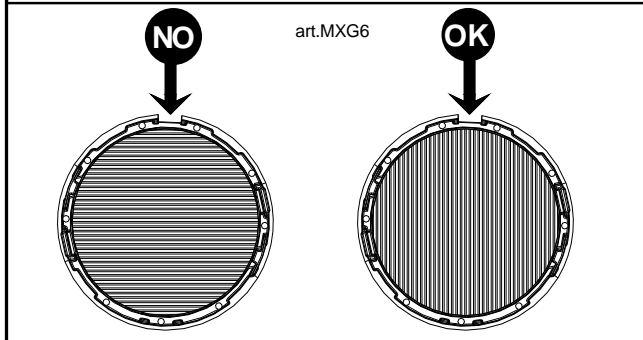
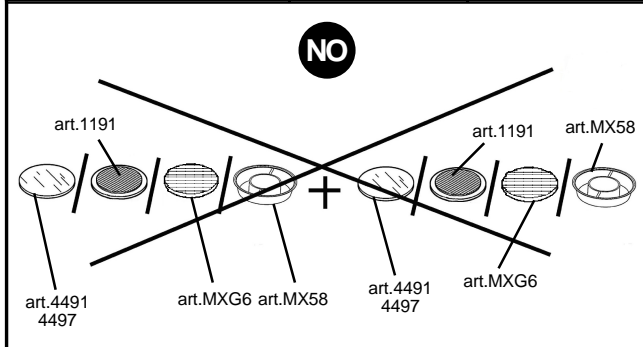

ART.	 art.
MF13-MF14-MF15-MF16-MF17 MF18-MF19-MF20-MF21-MF22 MF23-MF24-ML16-ML17-ML18 ML19-ML20-ML21-ML22-ML23 ML24-ML25-ML26-ML27	MXG6

MP16-MP17-MP18-MP19-MP20 MP21-MP22-MP23-MP24-MP25 MP26-MP27-MP28-MP29-MP30 MP31-MP32-MP33-MP34-MP35 MP36-MP37-MP38-MP39-MP40 MP41-MP42-MP43-MP44-MP45 MP46-MP47-MP48-MP49-MP50 MP51-MP52-MP53-MP54-MP55 MP56-MP57- Q199- Q200- Q201 Q202- Q203- Q204- Q205- Q206 Q207- Q208- Q209- Q210- Q211 Q212- Q213- Q214- Q215- Q216 Q217- Q218- Q219- Q220- Q221 Q222- Q223- Q224- Q225- Q226 Q227- Q228- Q229- Q230- Q231	MXG6
---	------

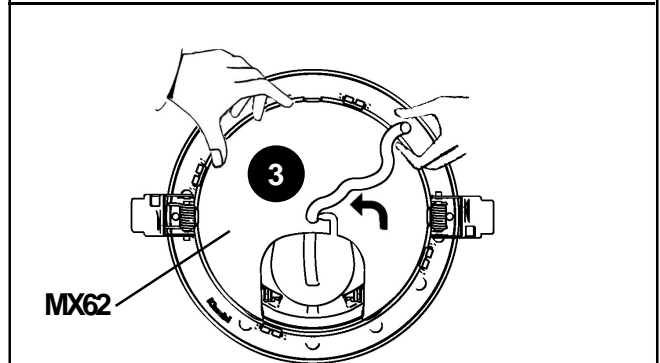
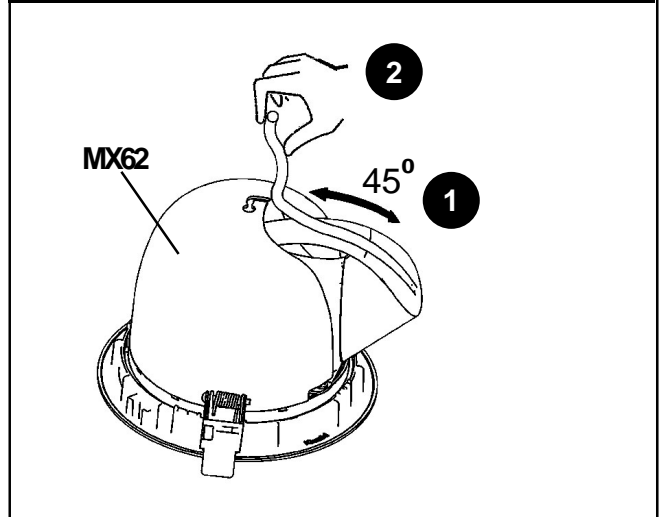
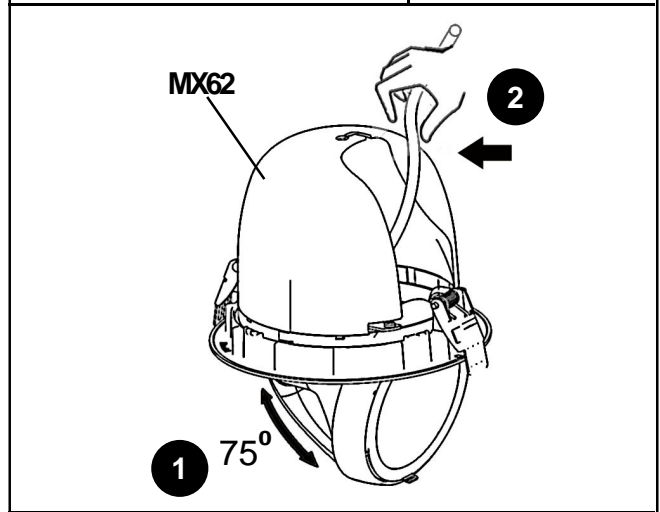

INSTALLAZIONE DEGLI ACCESSORI
INSTALLING THE ACCESSORIES
INSTALLATION DES ACCESSOIRES
INSTALLATION DER ZUBEHÖRE
INSTALLATIE VAN DE ACCESSOIRES
INSTALACIÓN DE LOS ACCESORIOS
INSTALLATION AF TILBEHØR
INSTALLERING AV TILBEHØR
INSTALLATION AV TILLBEHÖR
МОНТАЖ ВСПОМОГАТЕЛЬНЫХ КОМПЛЕКТУЮЩИХ
配件安装

I N.B.: L'apparecchio consente l'installazione di un solo accessorio.
GB N.B.: Only one accessory can be installed on the fixture.
F N.B.: On ne peut installer qu'un accessoire sur cet appareil.
D N.B.: Das Gerät ermöglicht die Installation von nur einem Zubehörteil.
NL N.B.: De armatuur is slechts geschikt voor de installatie van één accessoire.
E NOTA: El aparato sólo puede montar un accesorio.
DK N.B.: Det er kun muligt at installere et tilbehør på armaturet.
N N.B.: Kun en tilbehørsinnretning kan installeres på lysarmaturen.
S OBS! Endast ett tillbehör kan installeras på utrustningen.
RUS ПРИМЕЧАНИЕ: Прибор допускает установку только одного вспомогательного устройства.
CN 注意: 仅能在装置上安装一个附件。

I Utilizzare lampade di potenza adeguata, in funzione dell'accessorio installato.
GB Use lamps with appropriate wattage according to the accessory installed.
F Utilisez des lampes ayant une puissance appropriée, selon le type d'accessoire installé.
D Bitte verwenden Sie Lampen angemessener Leistung, je nach installiertem Zubehör.
NL Gebruik lampen van voldoende watt, naar gelang het geïnstalleerde accessoire
E Utilizar lámparas de potencia adecuada según el accesorio instalado.
DK Brug lyskilder med passende effekt, alt efter det installerede tilbehør.
N Bruk lamper med riktig ytelse etter tilbehøret som er installert.
S Använd lampor med lämplig effekt, beroende på vilka tillbehör som finns installerade.
RUS Используйте лампы надлежащей мощности в зависимости от установленного дополнительного элемента.
CN 根据安装的附件使用功率适中的光源。

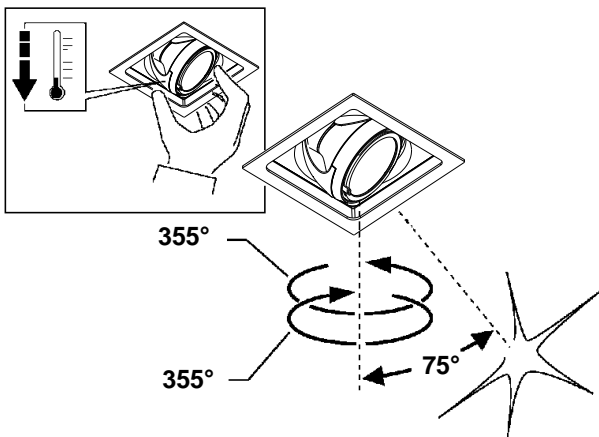
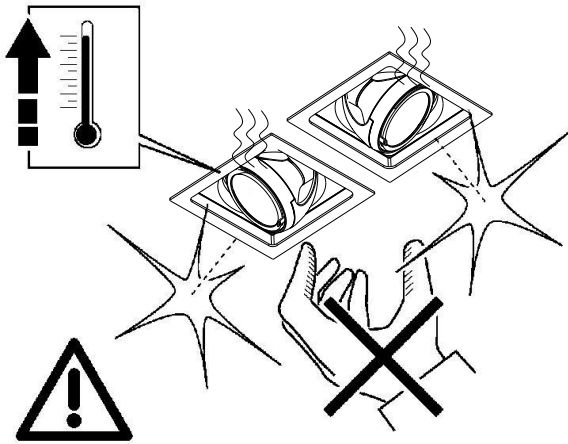
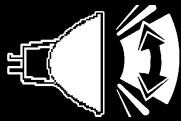

art. MF07 - MF08 - MF09 - MF10 - MF11 - MF12

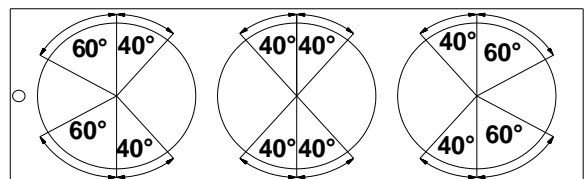
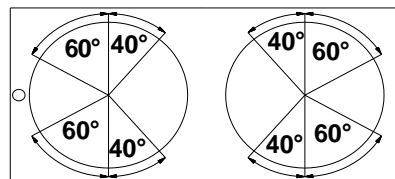
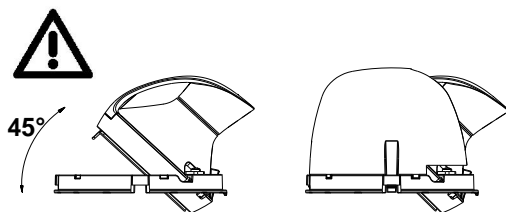
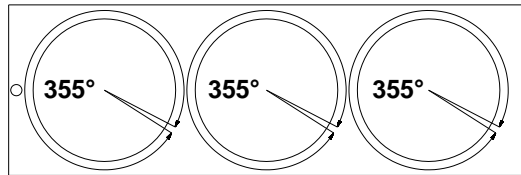
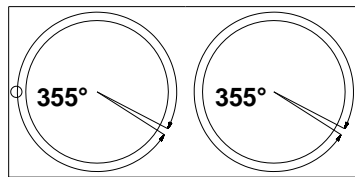
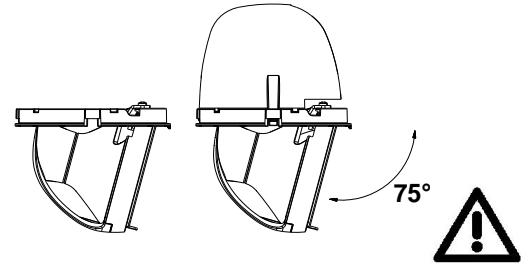
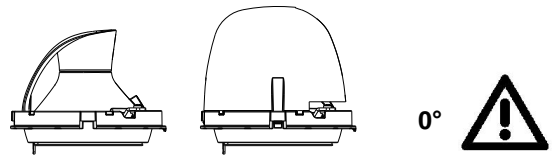

art. MF17 - MF18 - MF19 - MF20 - MF21 - MF22 - MF23 - MF24 -
 ML20-ML21-ML22-ML23-ML24-ML25-ML26-ML27 -MP23-MP24-
 MP25-MP26-MP27-MP28-MP29-MP30-MP31-MP32-MP33-MP34-
 MP35-MP36-MP44-MP45-MP46-MP47-MP48-MP49-MP50-MP51-
 MP52-MP53-MP54-MP55-MP56-MP57- Q199-Q200-Q201-Q202-
 Q203-Q204-Q205-Q206-Q207-Q208-Q209-Q210-Q211-Q212-
 Q213-Q214-Q215-Q216-Q217-Q218-Q219-Q220-Q221-Q222-
 Q223-Q224-Q225-Q226-Q227-Q228-Q229-Q230-Q231

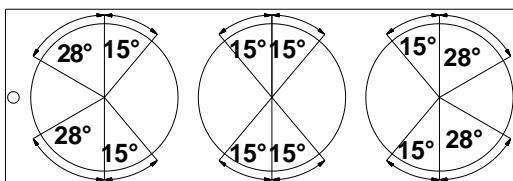
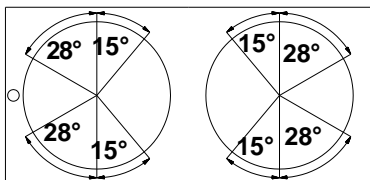
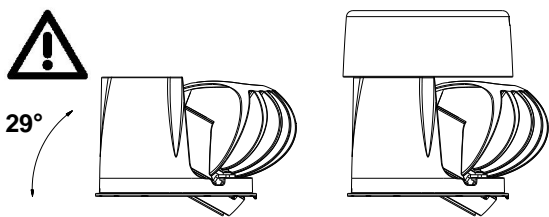
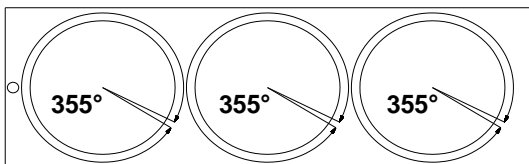
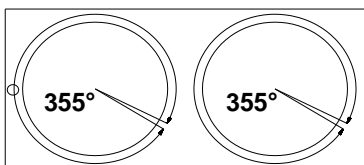
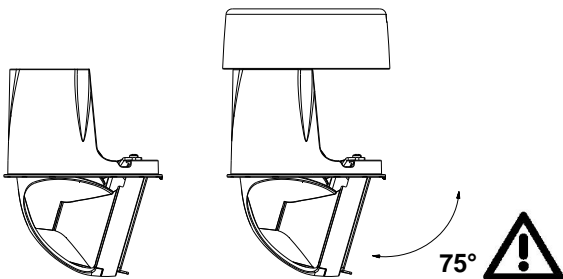
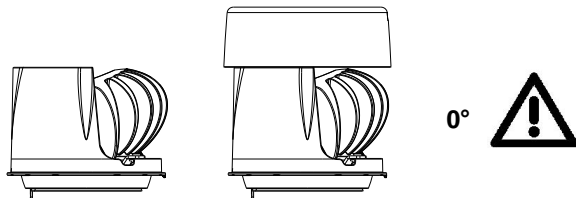

art. ML20 - ML21 - ML22 - ML23 - ML24 - ML25 - ML26 - ML27
 MP44 - MP45 - MP46 - MP47 - MP48 - MP49 - MP50 - MP51
 MP52 - MP53 - MP54 - MP55 - MP56 - MP57

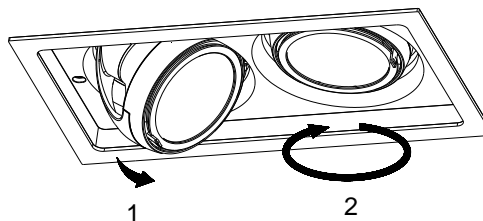
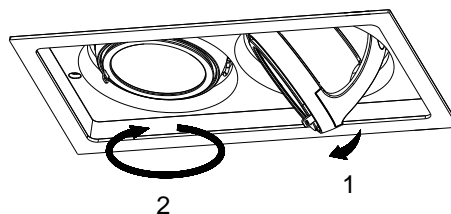
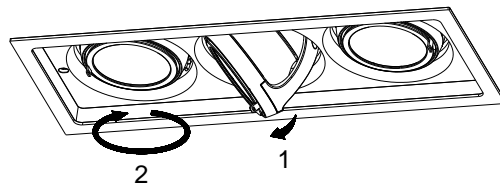
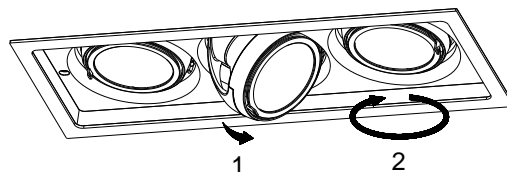
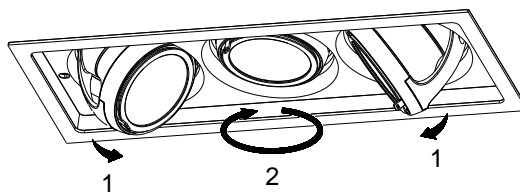

SOSTITUZIONE DEL LED
REPLACING THE LED
REPLACEMENT DE LA LED
AUSTAUSCHEN DER LED
VERVANGEN VAN DE LED
REEMPLAZO DEL LED
UDSKIFTNING AF LYSDIODE
BYTE AV LYSDIOD
UTSKIFTING AV DEN LYSEMITTERENDE DIODEN
ЗАМЕНА СИД
发光二极管替换

I N.B.: Per la sostituzione del LED contattare l'azienda iGuzzini.

GB N.B.: For information on LED replacement please contact iGuzzini.

F N.B.: Pour procéder au remplacement de la LED, adressez-vous à la société iGuzzini.

D N.B.: Bezüglich des Austausches der LED kontaktieren Sie bitte die Firma iGuzzini.

NL N.B.: Voor het vervangen van de LED neemt u contact op met het bedrijf iGuzzini.

E NOTA: Para sustituir el LED llame a la empresa iGuzzini.

DK N.B.: For udsiftning af lysdioden, skal man kontakte iGuzzini.

N N.B.: For informasjon om skifte av LED, vennligst ta kontakt med iGuzzini.

S OBS! För byte av lysdioden, kontakta företaget iGuzzini.

RUS ПРИМЕЧАНИЕ: Для замены СИДов обращайтесь в компанию iGuzzini.

CN 注意: 如需LED更换的信息, 请联系iGuzzini.



VETRO SODICO-CALCICO TEMPRATO
TEMPERED SODA-LIME GLASS
VERRE SODIQUE-CALCIQUE TEMPRÉ
NATRIUM-KALZIUM-GLAS
GETEMPERD NATRIUMKALKGLAS
CRISTAL SÓDICO-CALCÁREO TEMPLADO
HÆRDET NATRONKALKGLAS
TEMPERERT KALK-NATRON-GLASS
HÄRDAT KALK-SODAGLAS
ЗАКАЛЕННОЕ НАТРИЕВО-КАЛЬЦИЕВОЕ СТЕКЛО
钢化钙钠玻璃

I Sostituire lo schermo di protezione danneggiato, richiedendo le specifiche tecniche al costruttore. Non utilizzare l'apparecchio senza lo schermo.

Attenzione agli oggetti deteriorabili dai raggi U.V. .

GB Replace the damaged protective screen, requesting the technical specifications from the manufacturer. Do not use the luminaire without the screen.

Be careful of the objects that deteriorate when exposed to UV rays.

F Remplacez l'écran de protection endommagé en demandant au fabricant les spécifications techniques correspondantes. N'utilisez pas l'appareil sans écran.

Attention aux objets craignant les rayons U.V.

D Ein beschädigter Schutzschirm muß ersetzt werden. Verlangen Sie vom Hersteller Angaben hinsichtlich der technischen Daten. Die Leuchte darf auf keinen Fall ohne diesen Schirm eingesetzt werden.

Vorsicht bei Artikeln, die durch UV-Strahlen beschädigt werden könnten.

NL Vervang het protectiescherm als het beschadigd is en verlang van de fabrikant de juiste technische eigenschappen. Gebruik het apparaat niet zonder het scherm.

Wees voorzichtig met voorwerpen die door de ultraviolette stralen bedorven kunnen worden.

E Sustituir la pantalla de protección dañada solicitando las respectivas especificaciones técnicas al fabricante. No utilizar el aparato sin la pantalla.

Cuidado con los objetos deteriorables por los rayos ultravioletas.

DK Udsift en beskadiget beskyttelseskærm; og spørg fabrikanten til råds vedrørende de tekniske detaljer. Brug ikke armaturet uden skærm.

Vær opmærksom på genstande, der kan nedbrydes af U.V. stråler.

N Skift ut ødelagte vemeskjærmer, be om tekniske spesifikasjoner fra produsenten. Ikke bruk lysarmaturen uten skjermen.

Vær forsiktig med gjenstander som forringes ved eksponering for UV-stråler.

S Byt ut skadade skyddsskärmar. Rådfråga tillverkaren om tekniska specifikationer. Använd inte utrustningen utan skärmen.

Var försiktig med föremål som kan skadas av U.V.-strålar.

RUS Замените поврежденный защитный экран, запросив у производителя технические спецификации.

Не использовать прибор без экрана.

Обращайте внимание на предметы, которые могут быть повреждены под воздействием УФ излучения.

CN 一旦玻璃破碎后产品将不能再使用, 须联系生产商予以更换。

请勿使用无保护屏的光源。

注意那些受紫外线照射易损坏的物品。

PIXEL PRO FRAME

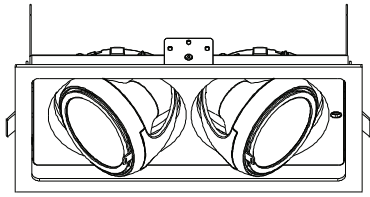

تحذير:

لا يمكن ضمان سلامة هذا الجهاز إلا إذا التزمت بهذه التعليمات، يجب حفظها في مكان آمن.

ATTENZIONE:

LA SICUREZZA DELL'APPARECCHIO E' GARANTITA SOLO CON L'USO APPROPRIATO DELLE SEGUENTI ISTRUZIONI; PERTANTO E' NECESSARIO CONSERVARLE.

WARNING:

THE SAFETY OF THIS FIXTURE IS GUARANTEED ONLY IF YOU COMPLY WITH THESE INSTRUCTIONS; REMEMBER TO CONSERVE IN A SAFE PLACE.

ATENCION:

LA SEGURIDAD DEL APARATO SE GARANTIZA SOLO CUMPLIENDO CUIDADOSAMENTE LAS SIGUIENTES

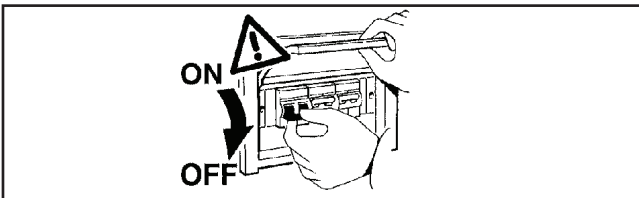

$d \dots m$

التزم بالحد الأدنى من المسافة عن التركيبية الضوئية، المقاس عن على امتداد المحاور المرئية في اللمبة.

- I Rispettare la distanza minima dall'oggetto illuminato, misurata lungo l'asse ottico della lampada.
- Respect the minimum distance from the illuminated object, measured along the optical axis of the lamp.
- Respetar la distancia mínima respecto del objeto iluminado, medida a lo largo del eje óptico de la lámpara.

HIT OK

LED NO

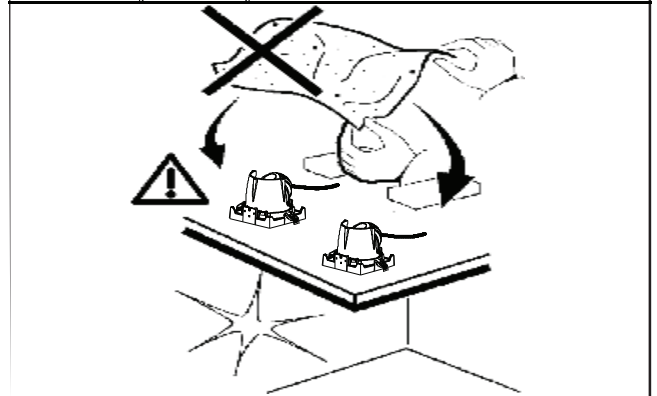
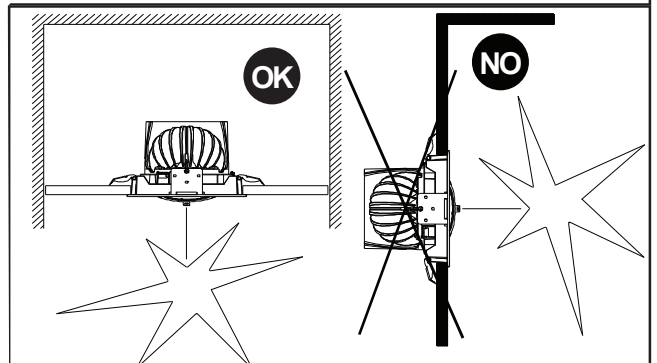
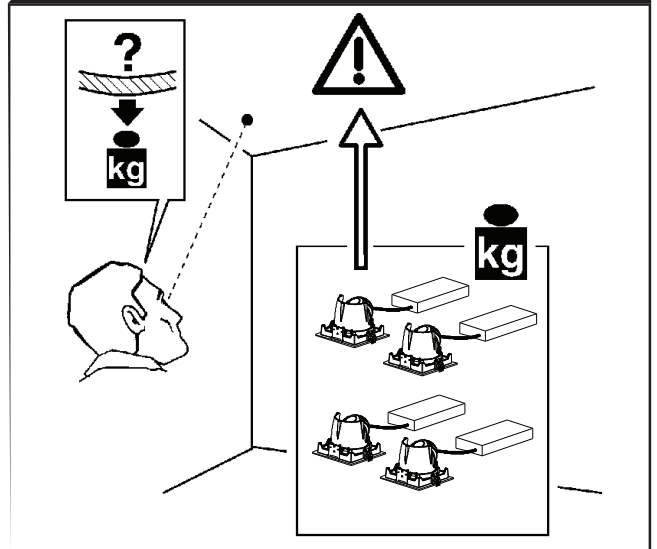
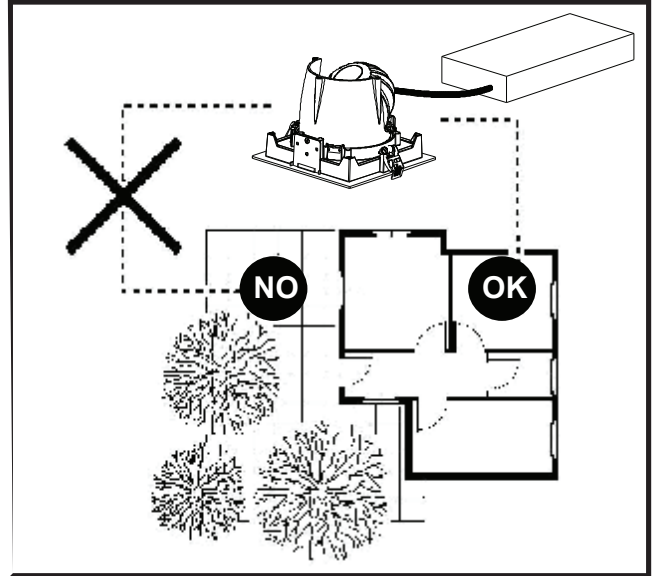



يجب عدم تغطية الجزء المركب، بأي حال من الأحوال،
بمواد عازلة أو ما شابه ذلك.

- I N.B.: L'apparechio non deve, in alcuna circostanza, essere coperto con materiale isolante o similare.
GB N.B.: The fixture must not be covered, under any circumstances, by insulating materials or the like.
E NOTA: El aparato no debe ser protegido con material aislante o parecido, por ninguna causa.

art. MF04 - MF05 - MF06 - MF07 - MF08 - MF09 - MF10 - MF11 - MF12 - MF13 - MF14 - MF15 - MF16 - MF17 - MF18 - MF19 - MF20 - MF21 - MF22 - MF23 - MF24-ML16-ML17-ML18-ML19-ML20-ML21-ML22-ML23-ML24-ML25-ML26-ML27-MP16-MP17-MP18-MP19-MP20-MP21-MP22-MP23-MP24-MP25-MP26-MP27-MP28-MP29-MP30-MP31-MP32-MP33-MP34-MP35-MP36-MP37-MP38-MP39-MP40-MP41-MP42-MP43-MP44-MP45-MP46-MP47-MP49-MP49-MP50-MP51-MP52-MP53-MP54-MP55-MP56-MP57 Q199-Q200-Q201-Q202-Q203-Q204-Q205-Q206-Q207-Q208 Q209-Q210-Q211-Q212-Q213-Q214-Q215-Q216-Q217-Q218 Q219-Q220-Q221-Q222-Q223-Q224-Q225-Q226-Q227-Q228 Q229-Q230-Q231

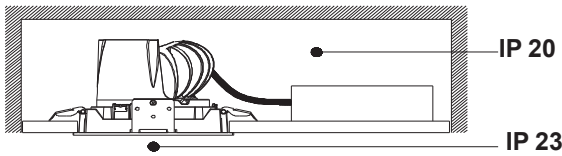

إذا قمت بتركيب المنتج على سقف غرفة مغلقة، ستكون درجة الحماية كما هي مبينة في الرسم.

- I Installando il prodotto a plafone in un vano chiuso, il grado di protezione è quello indicato in figura.
GB If you install the product on the ceiling in a closed room, the degree of protection is that indicated in the figure.
E Instalando el producto como plafón en un compartimento cerrado, el grado de protección es el que se indica en la figura.

art. MF04 - MF05 - MF06 - MF07 - MF08 - MF09 - MF10 - MF11 - MF12

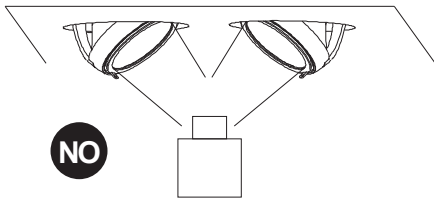

500 X 500 X 150
H=150mm

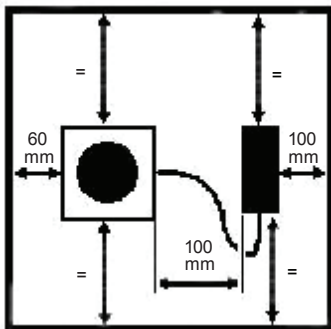

600 X 600 X 200
H=200mm

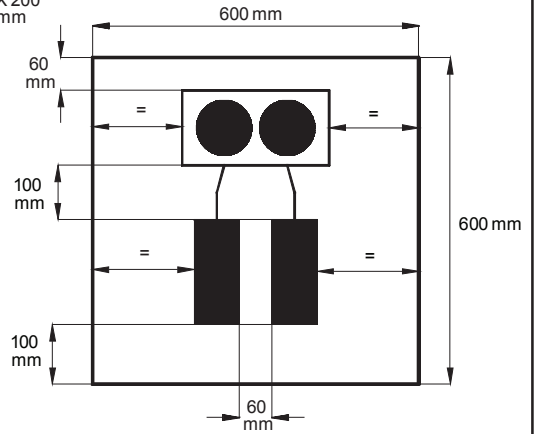

924 X 600 X 200
H=200mm

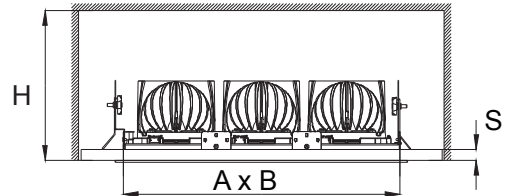
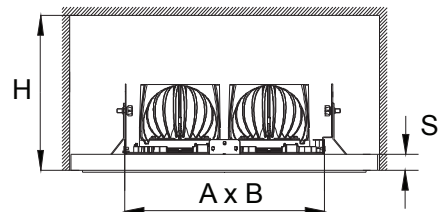
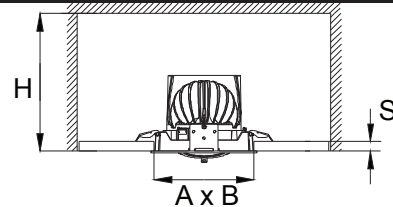
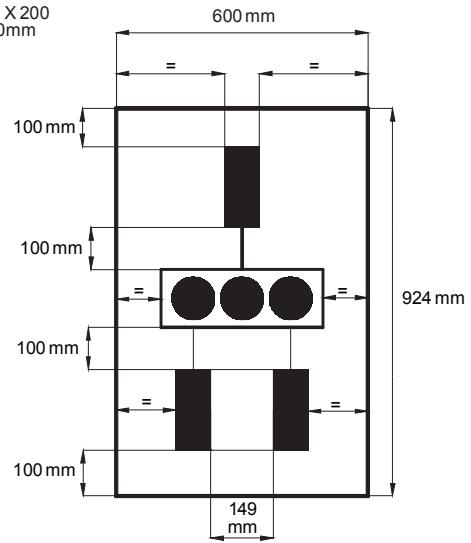

اطلع على الجدول التالي واعمل فتحة في السقف.

- I Consultare la seguente tabella e praticare il foro sul controsoffitto.
GB Consult following table and make hole on ceiling.
E Consultar el cuadro siguiente antes de taladrar los orificios en el falso techo.

ART.	mm			
	H min	S	A	B
MF04-MF05-MF06 MF13-MF14-MF15 MF16-ML16-ML17 ML18-ML19-MP16 MP17-MP18-MP19 MP20-MP21-MP22 MP37-MP38-MP39 MP40-MP41-MP42 MP43-Q199-Q200 Q201-Q202-Q203 Q204-Q205-Q206 Q207-Q208-Q209	150	1÷20	142	142
MF07-MF08-MF09 MF17-MF18-MF19 MF20-ML20-ML21 ML22-ML23-MP23 MP24-MP25-MP26 MP27-MP28-MP29 MP44-MP45-MP46 MP47-MP48-MP49 MP50-Q210-Q211 Q-212Q213-Q214 Q215-Q216-Q217 Q218-Q219-Q220	200	1÷20	270	138
MF10-MF11-MF12 MF21-MF22-MF23 MF24-ML24-ML25 ML26-ML27-MP30 MP31-MP32-MP33 MP34-MP35-MP36 MP51-MP52-MP53 MP54-MP55-MP56 MP57-Q221-Q222 Q223-Q224-Q225 Q226-Q227-Q228 Q229-Q230-Q231	200	1÷20	386	138

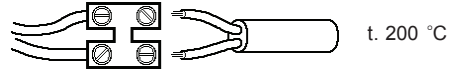
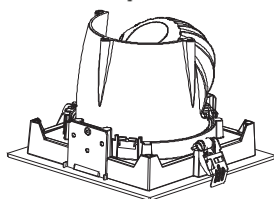
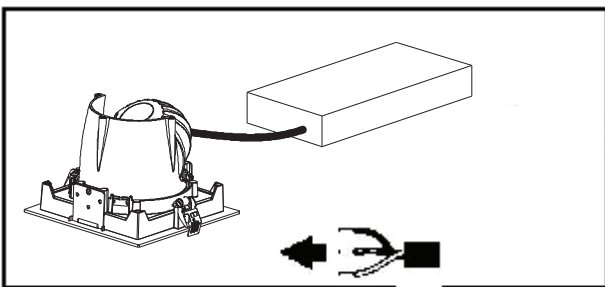
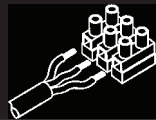

استعمل كبلات مضاعفة العزل ومقاومة لدرجات الحرارة العالية، عند التوصيل عن بالشبكة الكهربائية.

I Utilizzare per il collegamento alla rete cavi con doppio isolamento resistenti alle alte temperature.

GB When connecting to the mains, use cable with double insulation resistant to high temperatures.

Para efectuar la conexión a la red, utilizar cables con doble aislamiento resistentes a altas temperaturas.

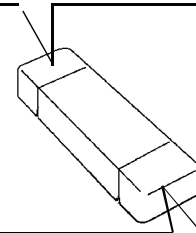
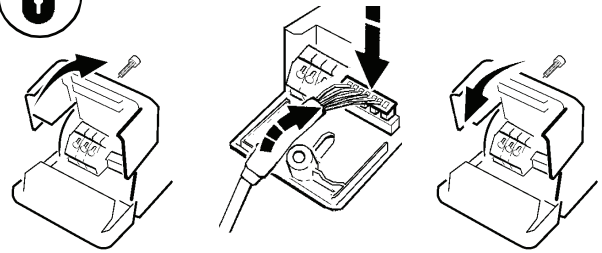

مصدر التيار
ALIMENTAZIONE
POWER SUPPLY
CEBADOR

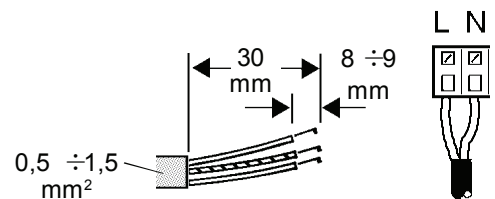

DALI

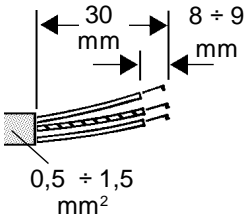
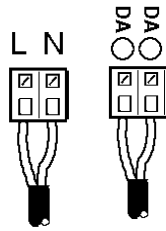
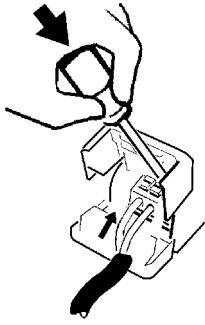

مصدر التيار
ALIMENTAZIONE
POWER SUPPLY
CEBADOR

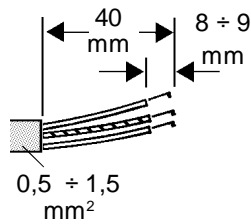

خط لجهاز التحكم بشدة الضوء (DALI)
LINEA PER DIMMERAZIONE (DALI)
LINE FOR DIMMING (DALI)
LÍNEA PARA REGULACIÓN INTENSIDAD LU-
MINOSA (DALI)

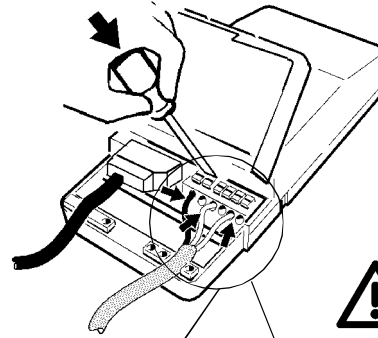
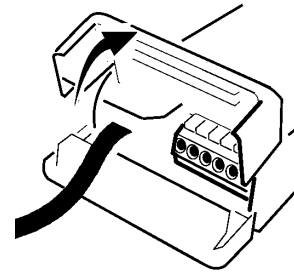

مصدر التيار
ALIMENTAZIONE
POWER SUPPLY
CEBADOR

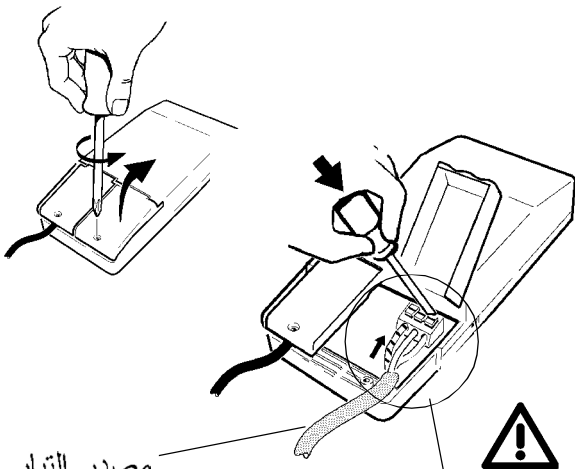

مصدر التيار
ALIMENTAZIONE
POWER SUPPLY
CEBADOR

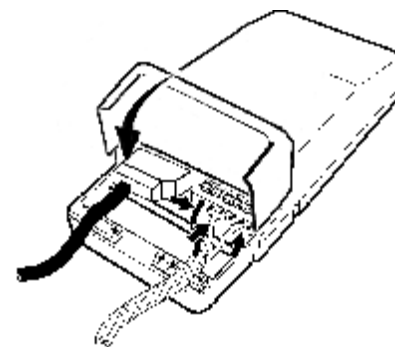
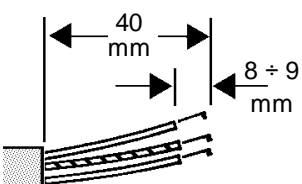
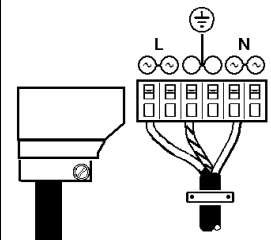
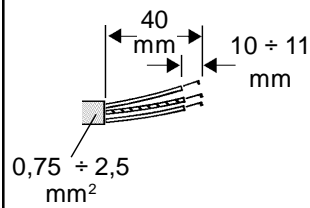

DALI

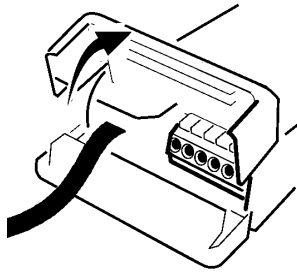

مصدر التيار
ALIMENTAZIONE
POWER SUPPLY
CEBADOR

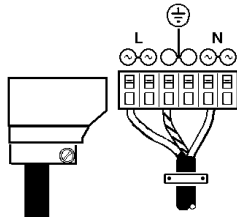
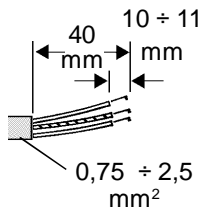

خط لجهاز التحكم بشدة الضوء (DALI)
LINEA PER DIMMERAZIONE (DALI)
LINE FOR DIMMING (DALI)
LÍNEA PARA REGULACIÓN INTENSIDAD LU-
MINOSA (DALI)

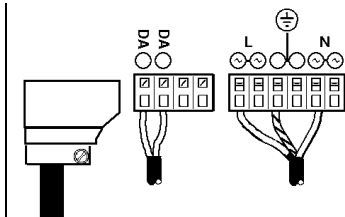
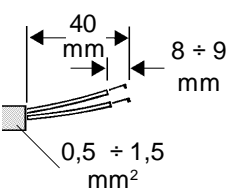

DALI

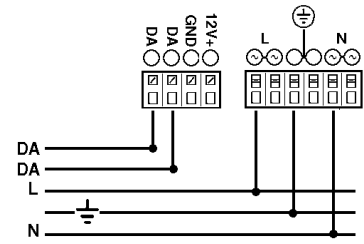

TOUCH DIM

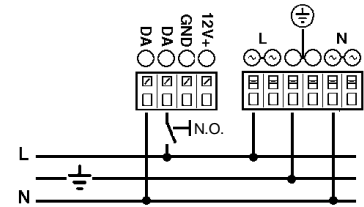

يمكن أن يتم تخفيض إضاءة الأجهزة ذات الكابلات الرقمية؛ وذلك عن طريق استخدام أجهزة الإمداد بالطاقة الكهربائية "دالي" (DALI)، أو عن طريق استخدام زر يكون مفتوحًا في وضعه الطبيعي (N.O.)؛ حيث يتم التوصيل كما هو مبين في المخطط.

I I dispositivi con cablaggio digitale possono essere dimmerati con dispositivi DALI o con pulsante normalmente aperto (N.O.) da collegare come da schema.

GB Devices with digital control gear may be dimmed using DALI devices or a normally-open button (N.O.) to be connected as shown in the diagram.

E Los dispositivos con cableado digital pueden regularse con dispositivos DALI o con un interruptor de botón normalmente abierto (N.O.) que se conecta según ilustrado en el esquema.

يمكن أن يتسبب التحكم في منتجات "دالي" المختلفة عن طريق الأزرار (مثل الأزرار: "دبم" - "سويفتش - دبم"، "بوتن - دبم"، "دايركت - دبم"، إلخ)، في حدوث مشاكل تتعلق بعملية التزامن بين هذه الأزرار. وإن كان من الممكن تجنب مثل هذه المشاكل، وذلك عن طريق تزويد بعض الأجهزة الإضافية بدعمك للاتصال المباشر بالشركة، وذلك للحصول على أكبر قدر من المعلومات.

I Pilotare diversi prodotti DALI tramite pulsante (es: Touch-dim, Switch-dim, Push-dim, Direct-dim, etc.) potrebbe causare dei problemi di sincronizzazione tra gli stessi. È possibile ovviare a questo problema dotandosi di dispositivi aggiuntivi. Per maggiori informazioni vi invitiamo a contattarci direttamente.

GB Controlling different DALI products through buttons (e.g.: Touch-dim, Switch-dim, Push-dim, Direct-dim, etc.) may lead to product synchronisation problems. This problem can be overcome by using additional devices. For further information, please contact us directly.

E El mando de varios productos DALI por tecla (ej: Touch-dim, Switch-dim, Push-dim, Direct-dim, etc.) podría causar problemas de sincronización entre ellos. Es posible prevenir este problema utilizando dispositivos adicionales. Para más información, contacte directamente con nosotros.

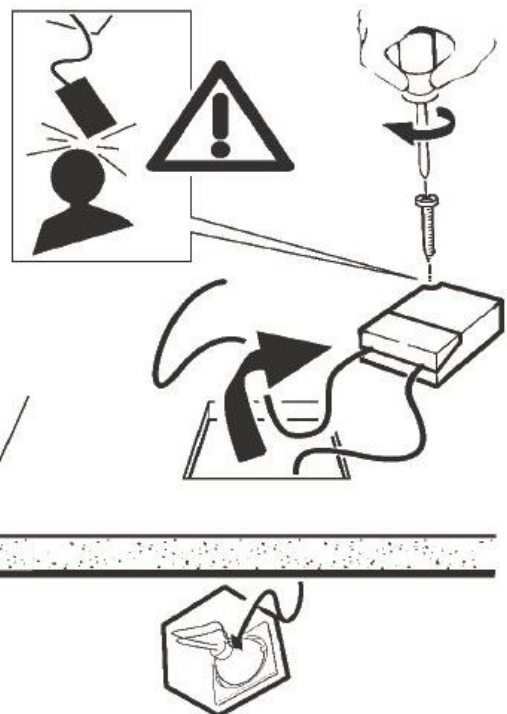

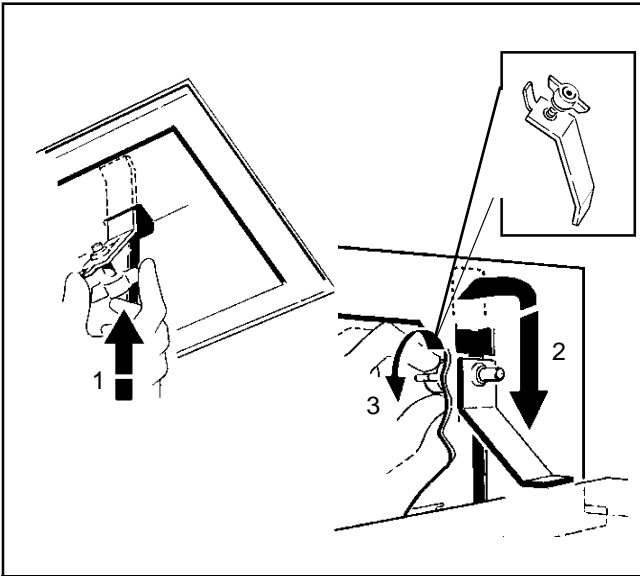

art. ML20 - ML21 - ML22 - ML23 - ML24 - ML25 - ML26 - ML27
 MP44 - MP45 - MP46 - MP47 - MP48 - MP49 - MP50 - MP51
 MP52 - MP53 - MP54 - MP55 - MP56 - MP57

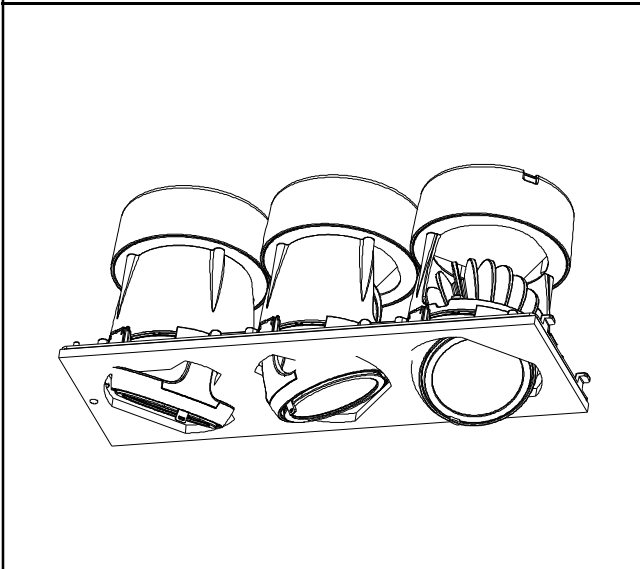
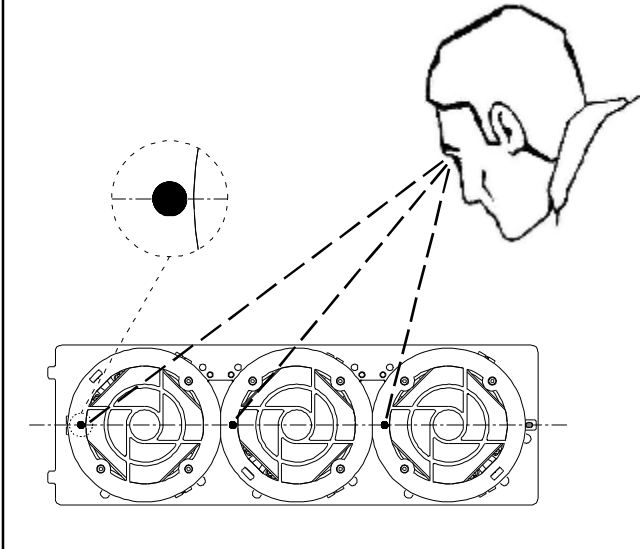

art. MF07 - MF08 - MF09 - MF10 - MF11 - MF12 - MF17 - MF18 -
 MF19 - MF20 - MF21 - MF22 - MF23 - MF24 - ML20 - ML21 - ML22
 - ML23 - ML24 - ML25 - ML26 - ML27 - MP23 - MP24 - MP25 -
 MP26 - MP27 - MP28 - MP29 - MP30 - MP31 - MP32 - MP33 -
 MP34 - MP35 - MP36 - MP44 - MP45 - MP46 - MP47 - MP48 -
 MP49 - MP50 - MP51 - MP52 - MP53 - MP54 - MP55 - MP56 -
 MP57 -

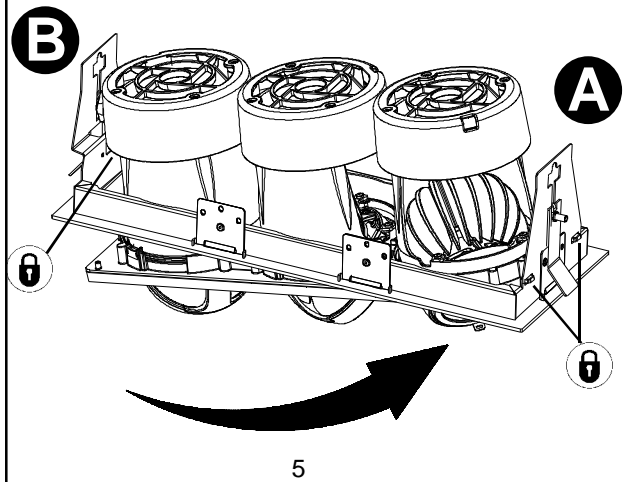
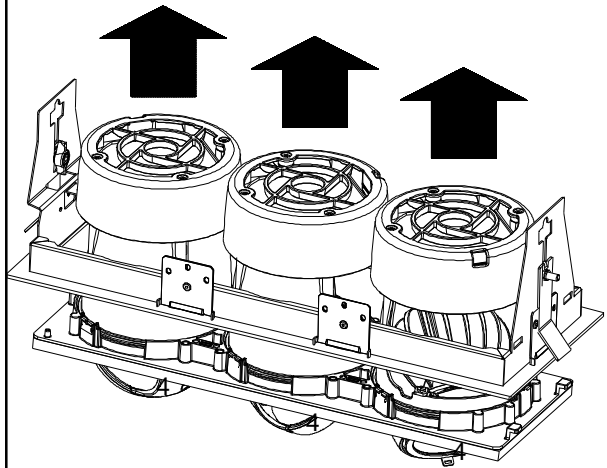

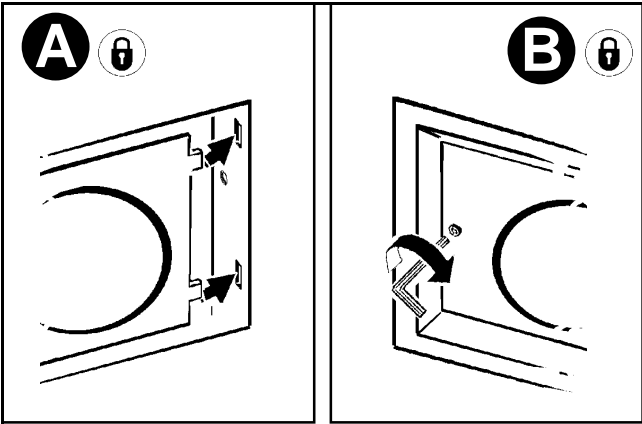

art. ML20 - ML21 - ML22 - ML23 - ML24 - ML25 - ML26 - ML27
 MP44 - MP45 - MP46 - MP47 - MP48 - MP49 - MP50 - MP51
 MP52 - MP53 - MP54 - MP55 - MP56 - MP57

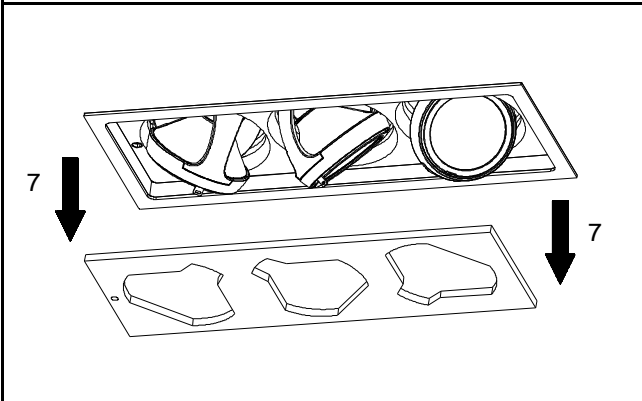
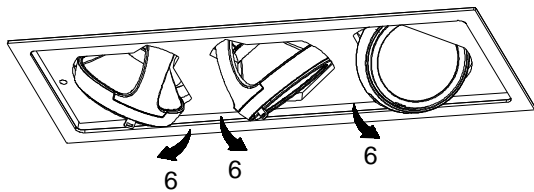

art. MF04 - MF05 - MF06 - MF13 - MF14 - MF15 - MF16 - ML16 -
 ML17 - ML18 - ML19 - MP16 - MP17 - MP18 - MP19 - MP20 -
 MP21 - MP22 - MP37 - MP38 - MP39 - MP40 - MP41 - MP42 -
 MP43

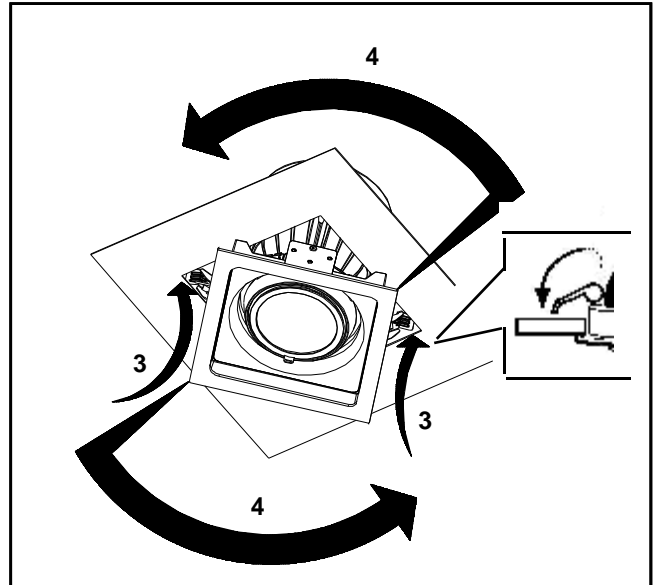
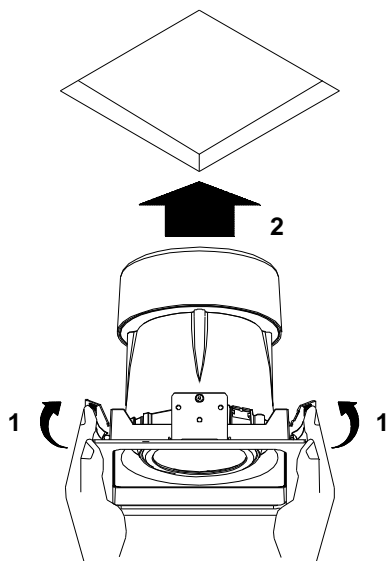

art. MF04-MF05-MF06-MF07-
 MF08-MF09-MF10-MF11-MF12

OK

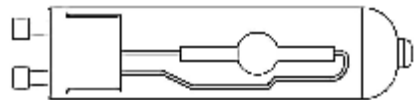

Only

GE Constant Color CMH 35W/930/GU6.5
 Constant Color CMH 35W/942/GU6.5

art. 4491-4497-1191-MXG6 -MX58-MX62-MX64

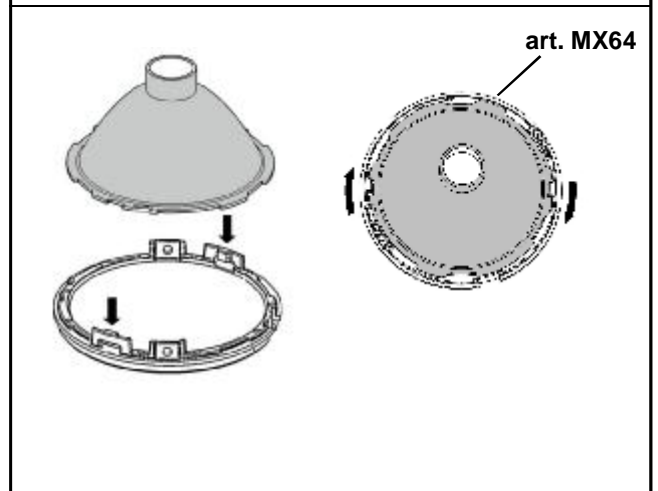
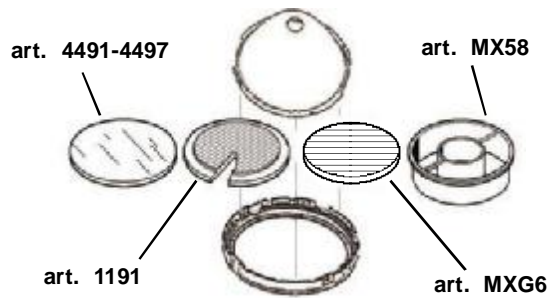

ART.	فيلتر - Filtro Filter - Filtro الصفيف		U.V.	art.	art.	art.
	Colorato ملون Coloured عرومفكف	art.				
MF04	4491	4497	1191	-	MX58	
MF05	4491	4497	1191	MXG6	MX58	
MF06	4491	4497	1191	MXG6	MX58	
MF07	4491	4497	1191	-	MX58	
MF08	4491	4497	1191	MXG6	MX58	
MF09	4491	4497	1191	MXG6	MX58	
MF10	4491	4497	1191	-	MX58	
MF11	4491	4497	1191	MXG6	MX58	
MF12	4491	4497	1191	MXG6	MX58	

ART.	art.	art.
MF04-MF05-MF06 MF07-MF08-MF09 MF10-MF11-MF12	MX62	MX64

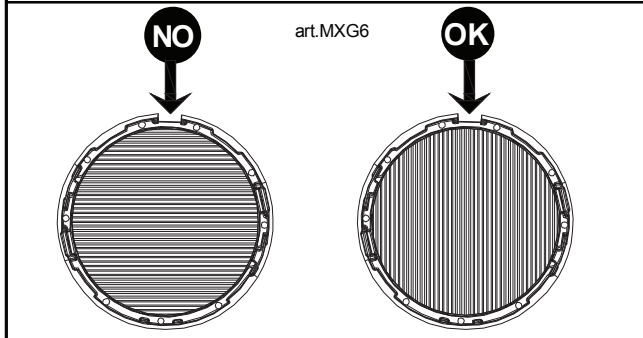
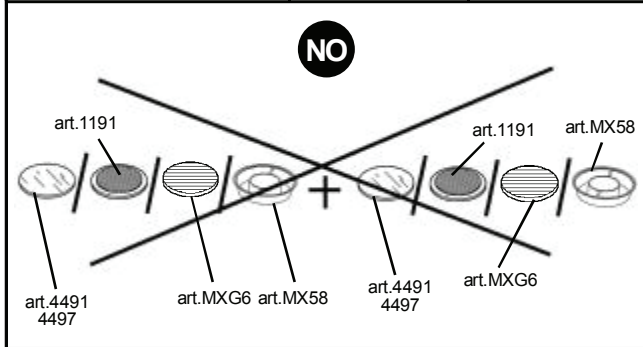

ART.	art.
MF13-MF14-MF15-MF16-MF17 MF18-MF19-MF20-MF21-MF22 MF23-MF24-ML16-ML17-ML18 ML19-ML20-ML21-ML22-ML23 ML24-ML25-ML26-ML27	MXG6

MP16-MP17-MP18-MP19-MP20 MP21-MP22-MP23-MP24-MP25 MP26-MP27-MP28-MP29-MP30 MP31-MP32-MP33-MP34-MP35 MP36-MP37-MP38-MP39-MP40 MP41-MP42-MP43-MP44-MP45 MP46-MP47-MP48-MP49-MP50 MP51-MP52-MP53-MP54-MP55 MP56-MP57- Q199- Q200- Q201 Q202- Q203- Q204- Q205- Q206 Q207- Q208- Q209- Q210- Q211 Q212- Q213- Q214- Q215- Q216 Q217- Q218- Q219- Q220- Q221 Q222- Q223- Q224- Q225- Q226 Q227- Q228- Q229- Q230- Q231	MXG6
---	------

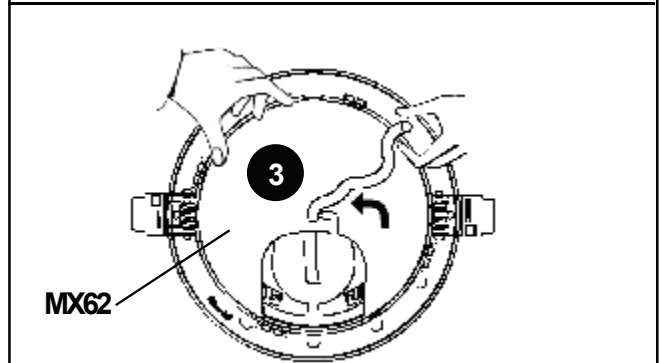
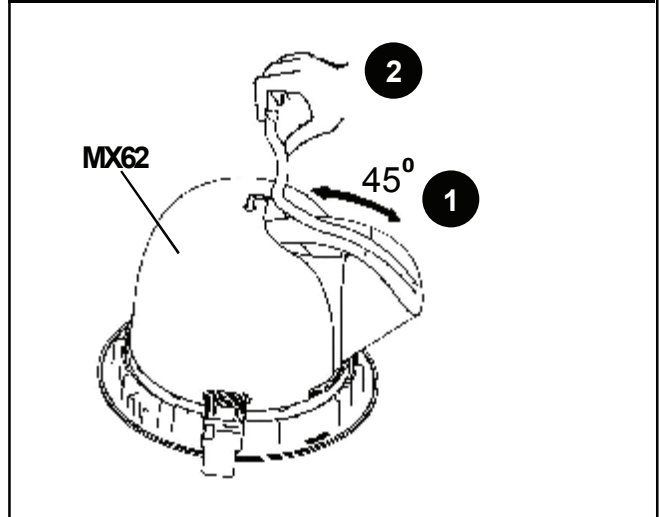
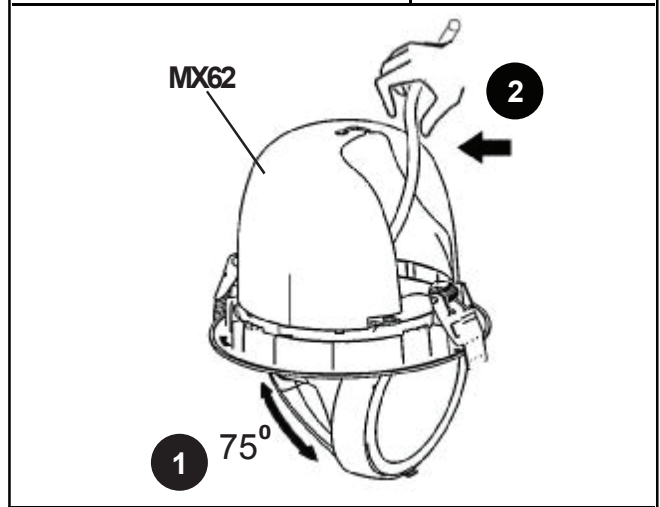

INSTALLAZIONE DEGLI ACCESSORI
 INSTALLING THE ACCESSORIES
 INSTALACION DE ACCESORIOS
 تركيب الملحقات

ملاحظة: لا يمكن تركيب أكثر من جهاز ملحوق واحد على الوحدة.

I N.B.: L'apparecchio consente l'installazione di un solo accessorio.
 GB N.B.: Only one accessory can be installed on the fixture.
 E NOTA: El aparato sólo puede montar un accesorio.

استخدم المصابيح ذات الفولطية الملائمة وفقا للأداة المركبة.

I Utilizzare lampade di potenza adeguata, in funzione dell'accessorio installato.
 GB Use lamps with appropriate wattage according to the accessory installed.
 E Utilizar lámparas de potencia adecuada según el accesorio instalado.

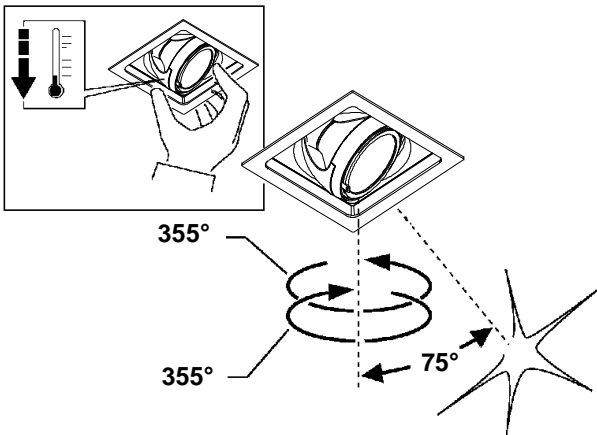
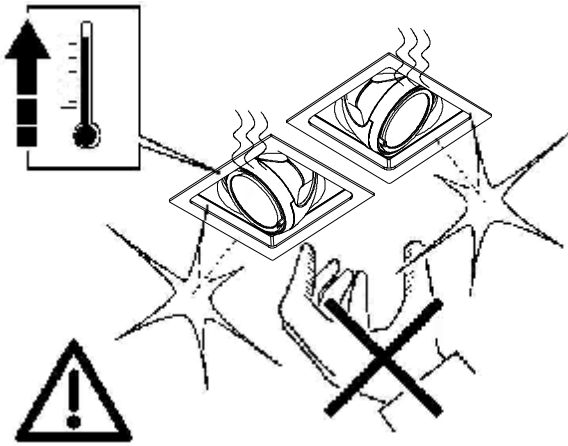

art. MF07 - MF08 - MF09 - MF10 - MF11 - MF12

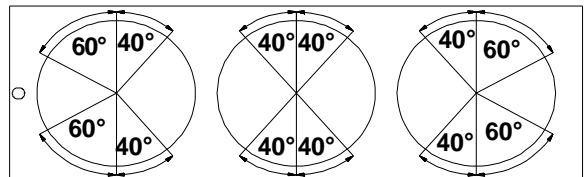
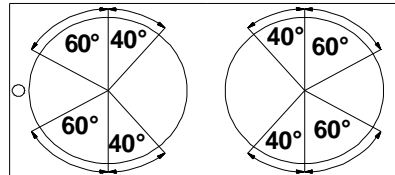
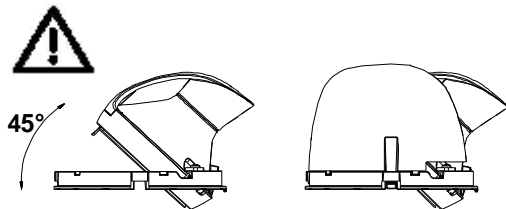
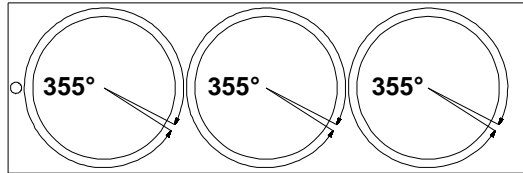
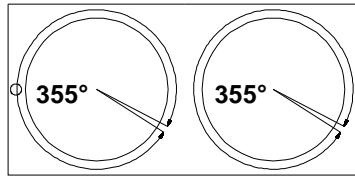
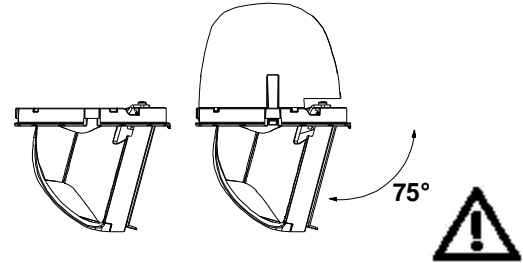
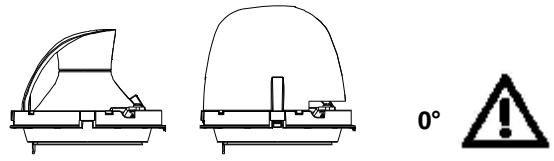

art. MF17 - MF18 - MF19 - MF20 - MF21 - MF22 - MF23 - MF24 -
 ML20-ML21-ML22-ML23-ML24-ML25-ML26-ML27 -MP23-MP24-
 MP25-MP26-MP27-MP28-MP29-MP30-MP31-MP32-MP33-MP34-
 MP35-MP36-MP44-MP45-MP46-MP47-MP48-MP49-MP50-MP51-
 MP52-MP53-MP54-MP55-MP56-MP57- Q199-Q200-Q201-Q202
 Q203-Q204-Q205-Q206-Q207-Q208-Q209-Q210-Q211-Q212
 Q213-Q214-Q215-Q216-Q217-Q218-Q219-Q220-Q221-Q222
 Q223-Q224-Q225-Q226-Q227-Q228-Q229-Q230-Q231

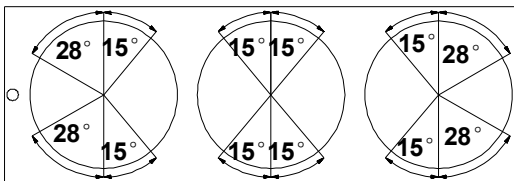
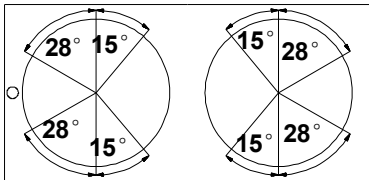
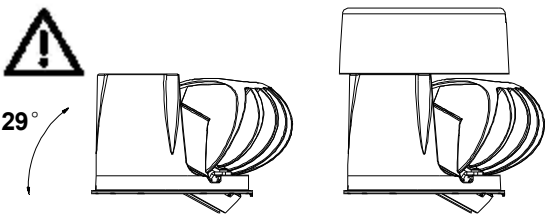
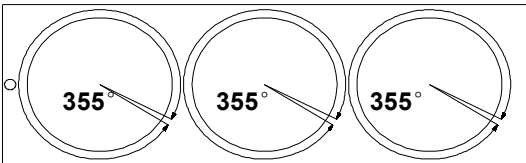
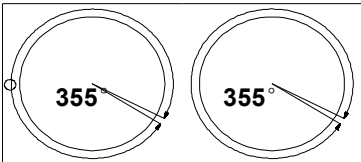
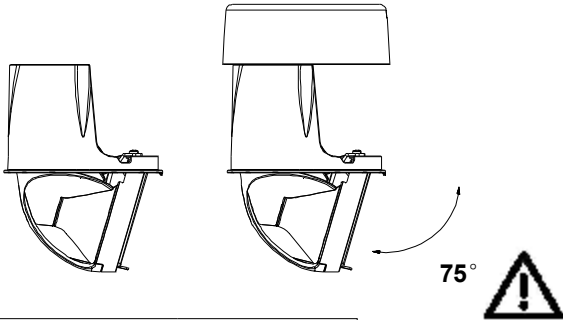
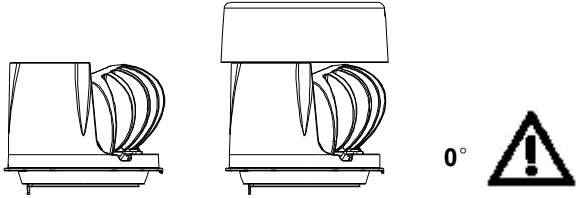

art. ML20 - ML21- ML22 - ML23 - ML24 - ML25 - ML26 - ML27
 MP44 - MP45 - MP46 - MP47 - MP48 - MP49 - MP50 - MP51
 MP52 - MP53 - MP54 - MP55 - MP56 - MP57

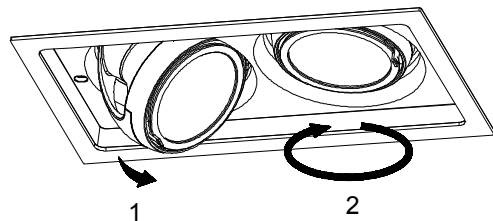
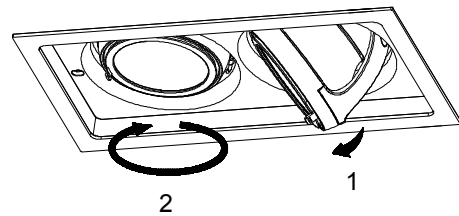
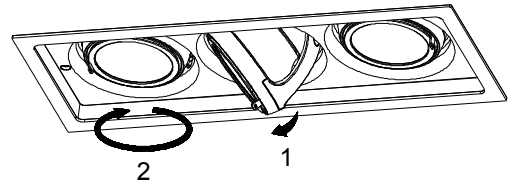
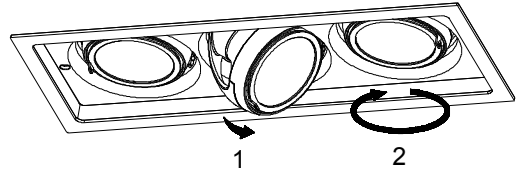
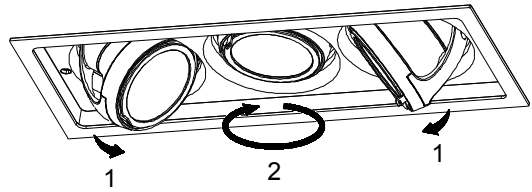

استبدال الضوء LED
SOSTITUZIONE DEL LED
REPLACING THE LED
REEMPLAZO DEL LED

ملاحظة: لاستبدال الضوء، اتصل بشركة iGuzzini

- I N.B.: Per la sostituzione del LED contattare l'azienda iGuzzini.
GB N.B.: For information on LED replacement please contact iGuzzini.
E NOTA: Para sustituir el LED llame a la empresa iGuzzini.



زجاج الحراري SODA-LIME
VETRO SODICO-CALCICO TEMPRATO
TEMPERED SODA-LIME GLASS
CRISTAL SÓDICO-CALCÁREO TEMPLADO

فم بتبديل شاشة الحماية المتلفة، وإطلب التحديدات التقنية من عر المصنع. لا تستخدم التركيبة الضوئية بدون الشاشة. احرص من تلف العناصر عند تعرضها للأشعة فوق البنفسجية.

- I Sostituire lo schermo di protezione danneggiato, richiedendo le specifiche tecniche al costruttore. Non utilizzare l'apparecchio senza lo schermo.
Attenzione agli oggetti deteriorabili dai raggi U.V. .
- GB Replace the damaged protective screen, requesting the technical specifications from the manufacturer. Do not use the luminaire without the screen.
Be careful of the objects that deteriorate when exposed to UV rays.
- E Sustituir la pantalla de protección dañada solicitando las respectivas especificaciones técnicas al fabricante. No utilizar el aparato sin la pantalla.
Cuidado con los objetos deteriorables por los rayos ultravioletas.

- I Istruzioni per le operazioni di servizio per l'apparecchio di illuminazione**
GB Instructions on luminaire service operations
F Instructions pour les opérations de service du luminaire
D Wartungsanleitung für die Leuchte
NL Instructies voor de onderhoudsoperaties op de verlichtingsarmatuur
E Instrucciones para las operaciones de servicio del aparato de alumbrado
DK Anvisninger i serviceindgreb på belysningsarmatur
N Anvisninger for betjening av lysapparatet
S Instruktioner för användning av belysningsanordningen
RUS Инструкция по эксплуатации осветительного прибора
CN 照明装置检修操作说明

Sostituire la lampada parzialmente esausta
 Replace the partly exhausted lamp
 Remplacer la lampe partiellement épuisée
 Die teilweise erschöpfte Lampe austauschen
 Vervang de gedeeltelijk lege lamp
 Sustituir la lámpara parzialmente agotada
 Udskift den delvist udtjente pære
 Skifte ut den delvis utbrente lyspæren
 Byt ut den delvis förbrukade lampan
 Замена частично отработавшей лампочки
 更换部分老化的灯泡



Spegnimento
 Switch it off
 Extinction
 Ausschaltung
 Uitschakeling
 Apagado
 Slukning
 Slukking
 Släckning
 Выключение
 关灯

Interrompere l'alimentazione dell'apparecchio
 Cut the power supply to the luminaire
 Couper l'alimentation du luminaire
 Stromversorgung der Leuchte unterbrechen
 Onderbreek de voeding van het apparaat
 Interrumpir la alimentación del aparato
 Afbryd armaturets strømforsyning
 Avbryt strømtilførselen til apparatet
 Koppla från anordningens strömförsörjning
 Отключить электропитание прибора
 中断装置供电



Aprire l'apparecchio
 Open the fixture
 Ouvrir le luminaire
 Das Gerät öffnen
 Open het apparaat
 Abrir el aparato
 Åbn armaturet
 Åpne apparatet
 Öppna anordningen
 Раскрыть прибор
 打开装置



Rimuovere la lampada esausta
 Remove the exhausted lamp
 Retirer la lampe épuisée
 Die alte Lampe entnehmen
 Verwijder de lege lamp
 Quitar la lámpara agotada
 Tag den udtjente pære ud
 Fjerne den utbrente lyspæren
 Ta bort den förbrukade lampan
 Вынуть старую лампочку
 取出老化的灯泡

Portarla in un centro di riciclaggio
 Carry it to a recycling centre
 La porter dans une déchetterie pour son recyclage
 Ordnungsgemäß entsorgen
 Breng de lamp naar een recyclingcentrum
 Llevarla a un centro de reciclaje
 Aflever den på en genbrugsstation
 Lever den til en miljøstasjon
 Lämna in den till en återvinningsanläggning
 Сдать ее в пункт приема утильсырья
 将其送往回收中心



Inserire la nuova lampada
 Introduce the new lamp
 Installer la lampe neuve
 Die neue Lampe einsetzen
 Doe de nieuwe lamp op zijn plek
 Montar la nueva lámpara
 Sæt den nye pære i
 Sette i den nye pæren
 Sätt i den nya lampan
 Вставить новую лампочку
 装入新灯泡

Inserire la nuova lampada nel portalampana
 Fit the new lamp into the socket
 Installer la nouvelle lampe dans le support de lampe
 Die neue Lampe in den Sockel einsetzen
 Doe de nieuwe lamp in de lamphouder
 Montar la nueva lámpara en el portalampana
 Sæt den nye pære i fatningen
 Sette den nye pæren inn i lampeholderen
 Sätt i den nya lampan i lamphållaren
 Вставить новую лампочку в патрон
 将新灯泡插入灯泡架中



Riposizionare ottica
 Re-place the optic
 Remettre l'optique à sa place
 Die Optik wieder einsetzen
 Doe de optiek weer op zijn plaats
 Volver a montar la óptica
 Sæt den optiske enhed på plads
 Innstille linsen
 Flytta om optiken
 Отрегулировать линзы
 重新定位光头



Effettuare prova di funzionamento
 Perform operative test
 Procéder à un essai de fonctionnement
 Eine Funktionsprüfung durchführen
 Controleer de correcte werking
 Hacer una prueba de funcionamiento
 Afprøv funktionen
 Prøve om den fungerer
 Utför funktionstest
 Выполнить проверку исправности работы
 执行功能测试



I Istruzioni per la pulizia dell'apparecchio di illuminazione
GB Instructions on luminaire cleaning operations
F Instructions pour le nettoyage du luminaire
D Anweisungen zur Reinigung der Leuchte
NL Instructies voor de reiniging van de verlichtingsarmatuur
E Instrucciones para limpiar el aparato de alumbrado
DK Anvisninger i rengøring af belysningsarmaturet
N Anvisninger for rengjøring av lysapparatet
S Instruktioner för rengöring av belysningsanordningen
RUS Инструкции по чистке осветительного прибора
CN 照明装置清洁说明

Pulire l'apparecchio
Clean the fixture
Nettoyer le luminaire
Das Gerät reinigen
Reinig het apparaat
Limpiar el aparato
Rengør armaturet
Rengjøre apparatet
Rengör anordningen
Чистка прибора
清洁装置



Spegnimento
Switch it off
Extinction
Ausschaltung
Uitschakeling
Apagado
Slukning
Slukking
Släckning
Выключение
关灯

Interrompere l'alimentazione dell'apparecchio
Cut the power supply to the luminaire
Couper l'alimentation du luminaire
Stromversorgung der Leuchte unterbrechen
Onderbreek de voeding van het apparaat
Interrumpir la alimentación del aparato
Afbryd armaturets strømforsyning
Avbryt strømtilførselen til apparatet
Koppla från anordningens strömförsörjning
Отключить электропитание прибора
中断装置供电



Spolverare l'ottica esterna
Remove dust from the external optic
Dépoussiérer l'optique extérieure
Die externe Optik abstauben
Stof de externe optiek af
Quitar el polvo de la óptica exterior
Tør støvet af den udvendige optiske enhed
Fjerne støv fra den eksterne lysenheten
Damma av den yttre optiken
Вытереть пыль с внешней стороны линз
为外侧镜头掸尘

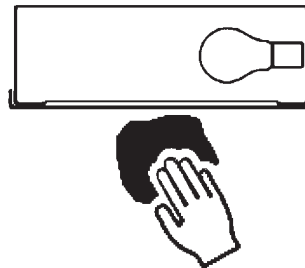

Lavare l'ottica esterna
Wash the external optic
Laver l'optique extérieure
Die externe Optik waschen
Was de externe optiek
Lavar la óptica exterior
Vask den udvendige optiske enhed
Vaske den eksterne lysenheten
Rengör den yttre optiken
Вымыть линзы с внешней стороны
清洁外镜头

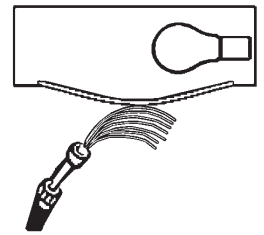

Rimuovere l'ottica
Remove the optic
Retirer l'optique
Die Optik abnehmen
Verwijder de optiek
Quitar la óptica
Tag den optiske enhed af
Fjerne lysenheten
Ta bort optiken
Снять линзы
取下镜头



Pulire la parte interna dell'apparecchio di illuminazione
Clean the inside of the fixture
Nettoyer l'intérieur du luminaire
Die Innenseite der Leuchte reinigen
Reinig de binnenzijde van de verlichtingsarmatuur
Limpiar el interior del aparato de alumbrado
Rengør belysningsarmaturets indvendige dele
Rengjøre lysapparatet innvendig
Rengör belysningsanordningen invändigt
Протереть осветительный прибор изнутри
清洁照明装置内部

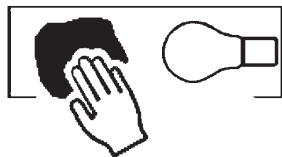

Riposizionare ottica
Re-place the optic
Remettre l'optique à sa place
Die Optik wieder einsetzen
Doe de optiek weer op zijn plaats
Volver a montar la óptica
Sæt den optiske enhed på plads
Innstille linsen
Flytta om optiken
Отрегулировать линзы
重新定位镜头

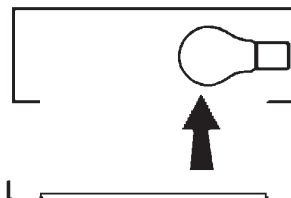

Effettuare prova di funzionamento
Perform operative test
Procéder à un essai de fonctionnement
Eine Funktionsprüfung durchführen
Controleer de correcte werking
Hacer una prueba de funcionamiento
Afprøv funktionen
Prøve om den fungerer
Utför funktionstest
Выполнить проверку исправности работы
执行功能测试

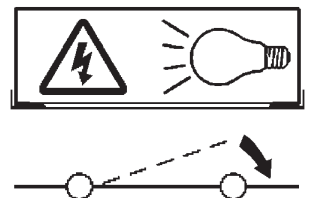

- I** Istruzioni per il fine vita e lo smaltimento dei componenti
GB Instructions on end-of-life and component disposal
F Instructions pour la gestion des composants en fin de vie et leur mise au rebut
D Anweisungen zur Entsorgung der Leuchtenkomponenten
NL Instructies voor het verwijderen van de armatuur en het recyclen van de onderdelen
E Instrucciones para el final de vida y la eliminación los componentes
DK Anvisninger i udtjent armatur og bortskaffelse af komponenter
N Anvisninger for endt levetid og avfallsbehandling av delene
S Instruktioner vid bortskaffning och kassering av komponenter
RUS Инструкции по утилизации прибора и его комплектующих по окончании его срока службы
CN 寿命期结束与零件废弃处置说明

<p>Spegnimento Switch it off Extinction Ausschaltung Uitschakeling Apagado Slukning Slukking Släckning Выключение 关灯</p> <p>Interrompere l'alimentazione dell'apparecchio Cut the power supply to the luminaire Couper l'alimentation du luminaire Stromversorgung der Leuchte unterbrechen Onderbreek de voeding van het apparaat Interrompirla alimentación del aparato Afbryd armaturets strømforsyning Avbryt strømtilførselen til apparatet Koppla från anordningens strömförsörjning Отключить электропитание прибора 中断装置供电</p> 	<p>Rimuovere la/e lampada/e per la dismissione Remove the lamp(s) for decommissioning Retirer la(les) lampe(s) pour sa(leur) mise au rebut Die Lampe/n ordnungsgemäß entsorgen Verwijder de lamp(en) voor het recyclen Quitar la(s) lámpara(s) para el desecho Tag pæren/pærerne ud til bortskaffelse Fjerne lampen/-e som skal kastes Ta bort lampan/-orna för bortskaffningen Вынуть лампочку/и для утилизации прибора 取出需要丢弃的灯泡</p> 	<p>Rimuovere la batteria per la dismissione Remove the battery for decommissioning Retirer la batterie pour sa mise au rebut Die Batterie ordnungsgemäß entsorgen Verwijder de batterij voor het recyclen Quitar la batería para el desecho Tag batteriet ud til bortskaffelse Fjerne batteriet som skal kastes Ta bort batteriet för bortskaffningen Вынуть батарейку для утилизации прибора 取出需要丢弃的电池</p> 	<p>Rimuovere l'apparecchio per la dismissione Remove the fixture for decommissioning Enlever le luminaire pour sa mise au rebut Das Gerät ordnungsgemäß entsorgen Verwijder het apparaat voor het recyclen Quitar el aparato para el desecho Tag armaturet ud til bortskaffelse Fjerne apparatet som skal kastes Ta bort anordningen för bortskaffningen Снять прибор для утилизации 取出需要丢弃的装置</p> 
---	--	--	--

<p>Inviare i materiali ad un centro di raccolta RAEE Send the materials to a WEEE collection centre Envoyer les matériaux dans une déchetterie DEEE Die Materialien in einem WEEE-Zentrum entsorgen Zend de materialen naar een recyclingscentrum voor de AEEA Enviar los materiales a un centro de recogida RAEE Afløver materialerne på et indsamlingscenter for elektronisk udstyr Sende materialene til en miljøstasjon for resirkulering av EE-avfall Skicka materialet till en RAEE uppsamlingscentral Сдать материалы в пункт приема утильсырья 将材料送往电气和电子垃圾回收中心</p> 			
--	--	--	--