

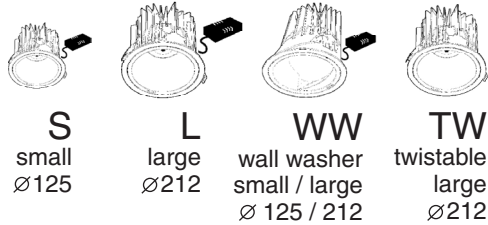

THE REFLEX EASY LED



ATTENZIONE:

LA SICUREZZA DELL'APPARECCHIO E' GARANTITA SOLO CON L'USO APPROPRIATO DELLE SEGUENTI ISTRUZIONI; PERTANTO E' NECESSARIO CONSERVARLE.

WARNING:

THE SAFETY OF THIS FIXTURE IS GUARANTEED ONLY IF YOU COMPLY WITH THESE INSTRUCTIONS; REMEMBER TO CONSERVE IN A SAFE PLACE.

ATTENTION:

LA SECURITE DE L'APPAREIL N'EST GARANTIE QU'EN CAS D'UTILISATION CORRECTE DES INSTRUCTIONS SUIVANTES; IL FAUT PAR CONSEQUENT LES CONSERVER.

ACHTUNG:

DIE SICHERHEIT DES GERÄTES WIRD NUR DURCH SACHGEMÄSSE BEFOLGUNG NACHSTEHENDER ANWEISUNGEN GEWÄHRLEISTET; IHRE AUFBEWAHRUNG IST DESHALB SEHR WICHTIG.

OPGELET:

DE VEILIGHEID VAN DI ATOESTEL IS SLECHTS DAN GEGARANDEERD ALS INDIEN DE VOLGENDE INSTRUCTIES STRIKT WORDEN TOEGEPAST: DAAROM MOET MEN ZE OOK BEWAREN.

ATENCIÓN:

LA SEGURIDAD DEL APARATO SE GARANTIZA SOLO CUMPLIENDO CUIDADOSAMENTE LAS SIGUIENTES INSTRUCCIONES; POR ELLO, ES NECESARIO CONSERVARLAS.

BEMÆRK:

SIKKERHEDEN VED BRUG AF ARMATURET KAN KUN GARANTERES, HVIS DISSE ANVISNINGER FØLGES; SØRG DERFOR FOR AT GEMME DEM.

ADVARSEL:

SIKKERHETEN TIL DETTE APPARATET GARANTERES KUN HVIS DU OVERHOLDER DISSE INSTRUKSJONENE; HUSK Å OPPBEVARE DEM PÅ ET TRYGT STED.

OBSERVERA!

UTRUSTNINGENS SÄKERHET KAN ENDAST GARANTERAS OM DESSA ANVISNINGAR RESPEKTERAS I DETALJ. SPARA DÄRFÖR DESSA ANVISNINGAR FÖR FRAMTIDA KONSULTATION.

ВНИМАНИЕ:

МЫ ГАРАНТИРУЕМ БЕЗОПАСНУЮ ЭКСПЛУАТАЦИЮ ИЗДЕЛИЯ ТОЛЬКО ПРИ СОБЛЮДЕНИИ СЛЕДУЮЩИХ ИНСТРУКЦИЙ; С ЭТОЙ ЦЕЛЬЮ НЕОБХОДИМО СОХРАНИТЬ ДАННУЮ БРОШЮРУ.

警告

为确保该装置安全，请遵守操作指示；并于安全场所放置。

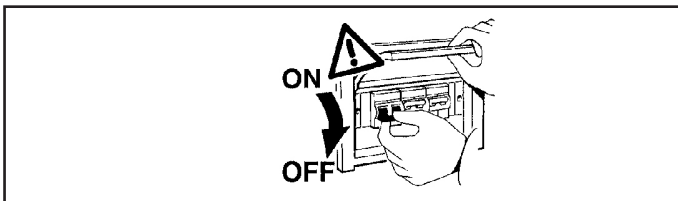

N.B.: DURANTE L'INSTALLAZIONE DEL SISTEMA RISPETTARE SCRUPolosAMENTE LE NORME IMPIANTISTICHE NAZIONALI VIGENTI.

N.B.: WHEN INSTALLING THE SYSTEM, MAKE SURE ALL CURRENT NATIONAL REGULATIONS RELATING TO INSTALLATION ARE OBSERVED.

N.B.: LORS DE L'INSTALLATION DU SYSTÈME VEUILLEZ RESPECTER RIGOREUSEMENT LES NORMES EN VIGUEUR EN LA MATIÈRE DANS LE PAYS.

N.B.: BEACHTEN SIE BEI DER INSTALLATION DES SYSTEMS UNBEDINGT DIE IM LAND GELTENDEN ANLAGETECHNISCHEN VORSCHRIFTEN.

N.B.: BIJ HET INSTALLEREN VAN HET SYSTEEM MOET U DE GELDENDE NATIONALE INSTALLATIE NORMEN STRIKT NALEVEN.

NOTA: DURANTE LA INSTALACIÓN DEL SISTEMA RESPETAR ESCRUPULOSAMENTE LAS NORMAS NACIONALES DE INSTALACIÓN EN VIGOR.

N.B.: UNDER INSTALLATION AF SYSTEMET SKAL MAN NØJE OVERHOLDE DE GÆLDENDE REGLER FOR DISSE ANLÆG.

N.B.: UNDER INSTALLASJON AV SYSTEMET MÅ DE NASJONALE ANLEGGSFORSKRIFTE NE OVERHOLDES NØYE.

OBS! UNDER INSTALLATIONEN AV SYSTEMET SKA GÄLLANDE NATIONELLA INSTALLATIONS FÖRESKRIFTER RESPEKTERAS I DETALJ.

ПРИМЕЧАНИЕ: В ПРОЦЕССЕ МОНТАЖА СИСТЕМЫ СТРОГО СОБЛЮДАЙТЕ НАЦИОНАЛЬНЫЕ ДЕЙСТВУЮЩИЕ НОРМАТИВЫ ПО ЭЛЕКТРОПРОВОДКЕ.

注意：安装系统时请务必遵守系统标准。

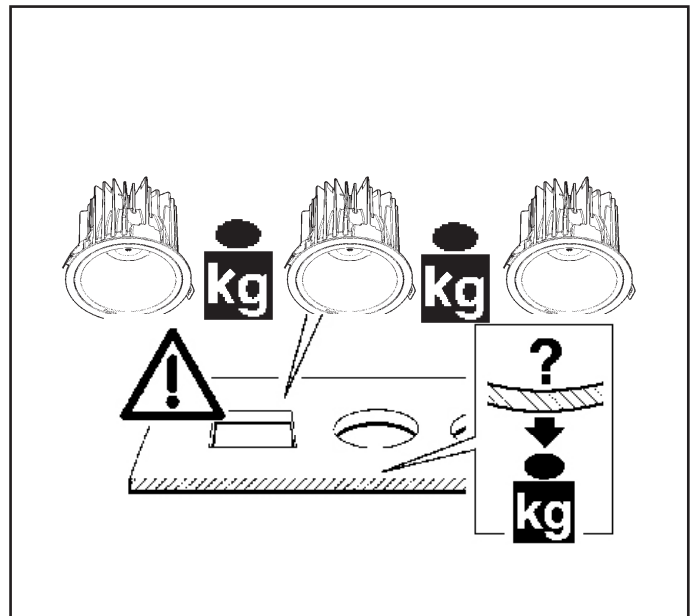
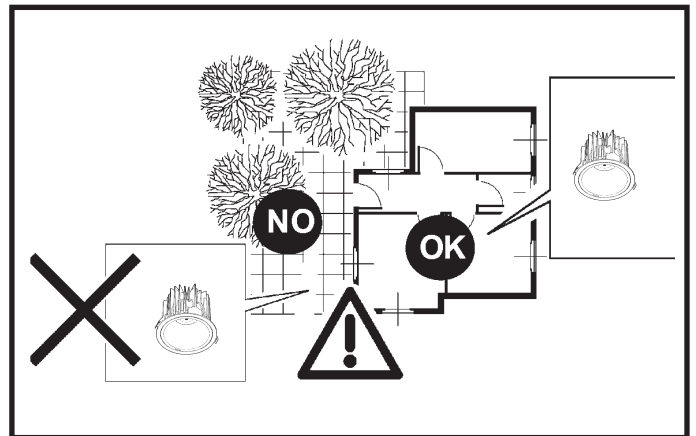
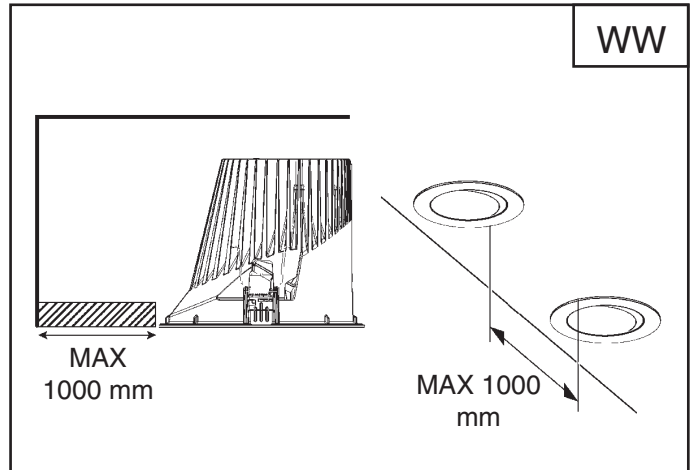
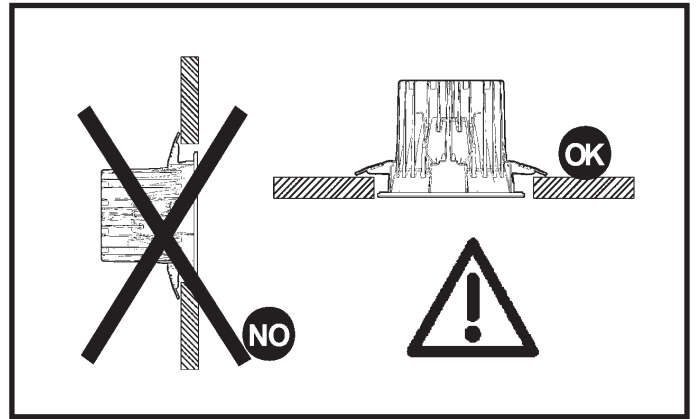



- I N.B.: Apparecchi non idonei ad essere coperti di materiale termicamente isolante.
- GB N.B.: Fixtures not suitable to be covered in thermally-insulating material.
- F N.B.: Appareils ne pouvant pas être couverts de matériau d'isolation thermique.
- D N.B.: Geräte nicht geeignet, um mit wärmeisolierendem Material abgedeckt zu werden.
- NL N.B.: Deze apparaten zijn niet geschikt om te worden bedekt met thermisch isolerend materiaal.
- E NOTA: Aparatos no aptos para ser cubiertos de material térmicamente aislante.
- DK N.B.: Armaturerne må ikke dækkes af varmeisolerende materiale.
- N N.B.: Apparatene passer ikke til å dekkes av termoisolerende materialer.
- S OBS! Utrustningen får inte täckas över med värmeisolerande material.
- RUS Приборы, непригодные для покрытия термоизоляционным материалом.
- CN 灯具不适宜用隔热材料加以覆盖!

TW

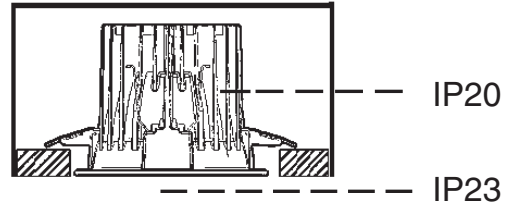

TW

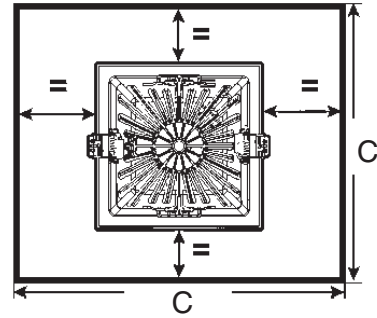

S

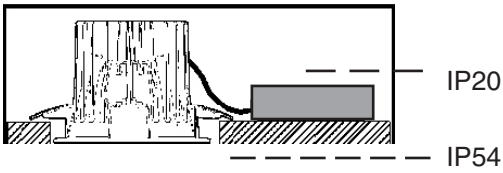

L

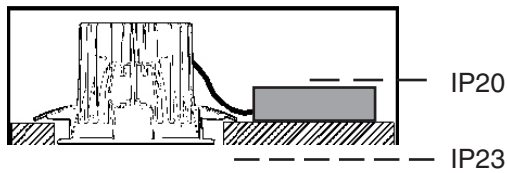

L

art. MC04 - MC17 - MC18 - MC60

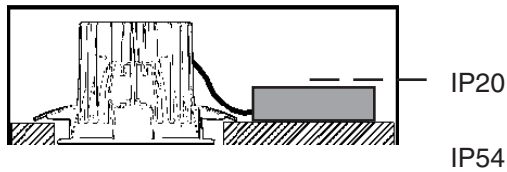

WW

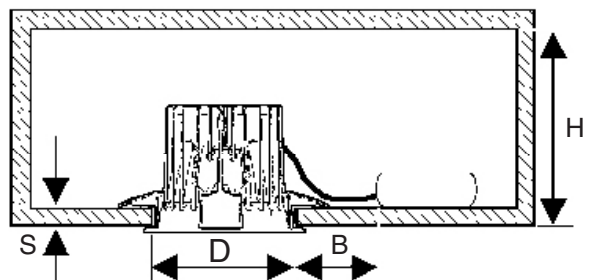
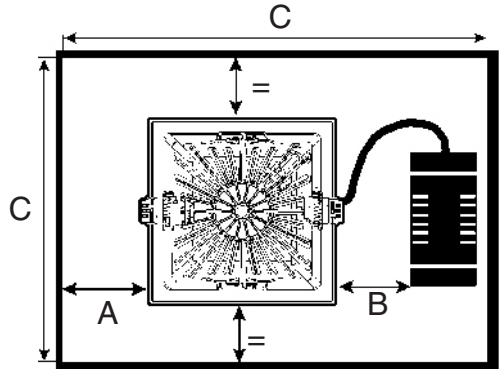
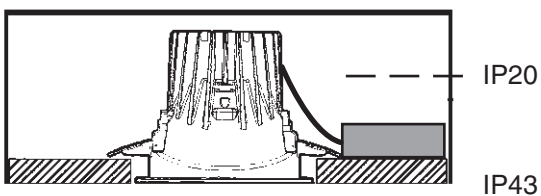

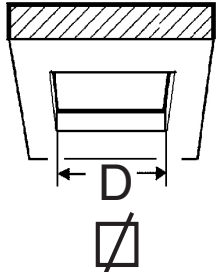
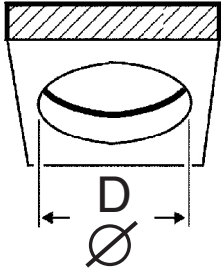

ART.	D mm	S mm	H mm	A mm	B mm	C mm
MB42 - MB43 - MB44	Ø 125	1 ÷ 20	108	80	350	
MB45 - MU16 - MU17			121			
MU18 - MU19 - MU20			150			
MB47 - MB48 - MB49 - MB50 - MU21			108			
MU22 - MU23 - MU24						
MU25						
MC00 - MC01 - MC02 - MC03 - MU26	Ø 125					
MU27 - MU28 - MU29 - MU30						
MB82 - MB83	Ø 212	150	100	500		
MB84 - MB85			150	600		
MB86 - MB87			100	500		
MB88 - MB89			150	600		
MB92 - MB93			100	500		
MB94 - MB95			150	600		
MB96 - MB97			100	500		
MB98 - MB99			150	600		
MC27 - MC28			100	500		
MC29 - MC30	Ø 212	150	150	600		
MC31 - MC32			100	500		
MC33 - MC34			150	600		
MC35 - MC36			100	500		
MB52 - MB53 - MC39	Ø 212	1 ÷ 25	100	50	100	500
MB54 - MB55 - MC40			150	600		
MB56 - MB57			100	500		
MB58 - MB59			150	600		
MB62 - MB63			150	600		
MB66 - MB67			100	500		
MB68 - MB69			150	600		
MB70 - MB71			100	500		
MB72 - MB73			150	600		
MB74 - MB75			100	500		
MB76 - MB77	Ø 212	100	150	600		
MB78 - MB79			100	500		
MB80 - MB81			150	600		
MC05 - MC06 - MC47			100	500		
MC07 - MC08 - MC48			150	600		
MC09 - MC10			100	500		
MC11 - MC12			150	600		
MC15 - MC16			100	500		
MC19 - MC20	Ø 212	150	150	600		
MC21 - MC22			100	500		
MC23 - MC24			100	500		
MC25 - MC26			150	600		
MC04 - MC17 - MC18 - MC60	Ø 212	180	150	600		
MC43			100	500		
MC44			150	600		

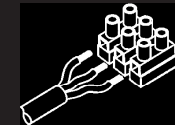
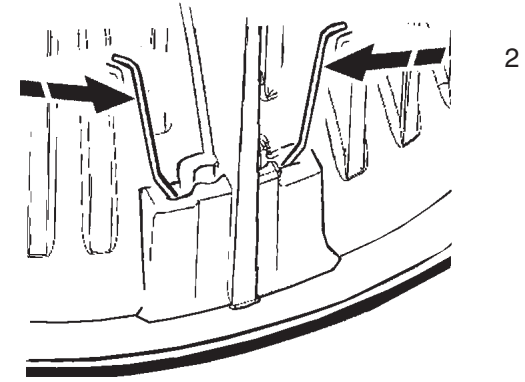
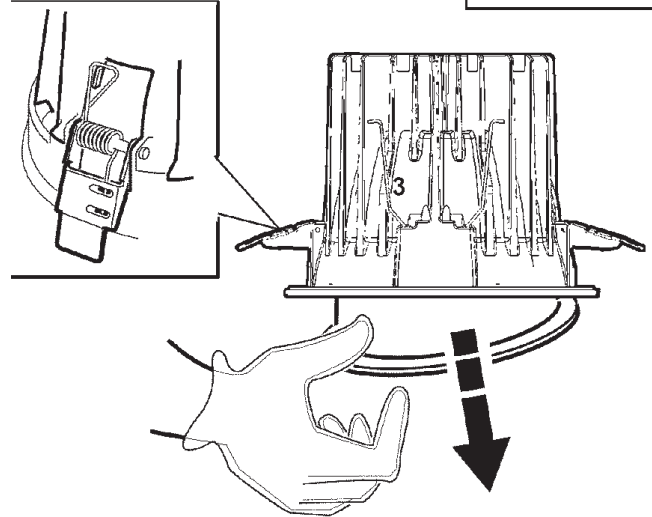

S / L / WW

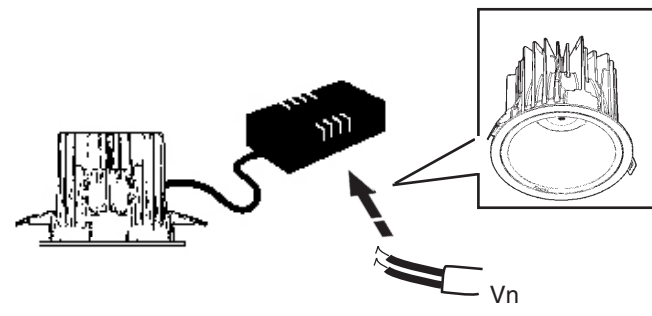

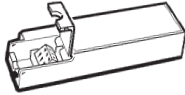

- I Per il collegamento elettrico fare riferimento alla marcatura dell'alimentatore.
- GB Refer to the marking on the power unit for the electrical connection.
- F Pour le raccordement électrique se reporter au marquage du ballast.
- D Den Anschluss an das Stromnetz gemäß Kennzeichnung auf dem Vorschaltgerät ausführen.
- NL Voor de elektrische aansluiting wordt verwezen naar de markering op de stroomvoorziening.
- E Para la conexión eléctrica hacer referencia a las informaciones marcadas en el alimentador.
- DK For elektrisk tilslutning, se strømforsyningens mærkning.
- N For elektrisk tilkobling, se merking på strømforsyningensheten.
- S För elanslutningen se till märkningen på nätdelen.
- RUS Для электрического подключения смотреть маркировку на блоке питания.
- CN 连接电线时请参考供电装置上的标记。

	S mm ²	Y mm	X mm	D mm
				
TRIDONIC	0,5 - 1,5	8,5 - 9,5	~ 40	/
OSRAM OT Fit		9 ± 0,5	~ 30	
OSRAM OT i DALI		8 - 9		7 - 11
PHILIPS Xitanium LH		9 ± 0,5	~ 25	
PHILIPS Xitanium SH	0,75 - 2,5	10 - 11	~ 40	/
PHILIPS Xitanium / m	0,2 - 1,5	8,5 - 9,5	~ 25	
GREE	0,75 - 2,5	10 - 11	~ 40	
* TCI DC MAXI JOLLY	0,5 - 2,5	6 ± 0,5	~ 30	3 - 8

- I Pilotare diversi prodotti DALI tramite pulsante (es: Touch-dim, Switch-dim, Push-dim, Direct-dim, etc.) potrebbe causare dei problemi di sincronizzazione tra gli stessi. È possibile ovviare a questo problema dotandosi di dispositivi aggiuntivi. Per maggiori informazioni vi invitiamo a contattarci direttamente.
- GB Controlling different DALI products through buttons (e.g.: Touch-dim, Switch-dim, Push-dim, Direct-dim, etc.) may lead to product synchronisation problems. This problem can be overcome by using additional devices. For further information, please contact us directly.
- F Piloter plusieurs produits DALI par bouton (ex : Touch-dim, Switch-dim, Push-dim, Direct-dim, etc.) pourrait causer des problèmes de synchronisation entre eux. Ce problème peut être évité en s'équipant de dispositifs supplémentaires. Pour de plus amples renseignements, veuillez nous contacter directement.
- D Die Steuerung verschiedener DALI-Produkte mittels Taste (z.B.: Touch-dim, Switch-dim, Push-dim, Direct-dim etc.) kann eventuell zu Synchronisierungsproblemen zwischen diesen führen. Dieses Problem lässt sich durch den Einsatz von zusätzlichen Geräten beheben. Wenn Sie weitere Informationen wünschen, setzen Sie sich bitte direkt mit uns in Verbindung.
- NL Het besturen van verschillende DALI producten m.b.v. dezelfde knop (bv.: Touch-dim, Switch-dim, Push-dim, Direct-dim, etc.) kan synchronisatieproblemen tussen de producten opleveren. Men kan dit probleem voorkomen door extra systemen aan te sluiten. Voor verdere informatie raden we u aan direct contact met ons op te nemen.
- E El mando de varios productos DALI por tecla (ej: Touch-dim, Switch-dim, Push-dim, Direct-dim, etc.) podría causar problemas de sincronización entre ellos. Es posible prevenir este problema utilizando dispositivos adicionales. Para más información, contacte directamente con nosotros.
- DK Hvis DALI-produkterne styres ved hjælp af knapperne (fx. Touch-dim, Switch-dim, Push-dim, Direct-dim osv.), kan det skabe problemer med synkronisering af samme. Dette problem kan undgås, hvis man køber ekstra enheder. For yderligere oplysninger, kontakt os direkte.
- N Å styre ulike DALI-produkter ved hjelp av en trykknappbryter (f.eks. touch-dim, switch-dim, push-dim, direct-dim, osv.) vil kunne føre til problemer med synkroniseringen mellom dem. Dette problemet kan løses ved hjelp av noen tilleggsinnretninger. Ta gjerne kontakt med oss for mer informasjon om dette.
- S Styrning av olika DALI-produkter med knapp (t.ex.: Touch-dim, Switch-dim, Push-dim, Direct-dim o.s.v.) kan orsaka synkroniseringsproblem mellan dessa. Detta problem kan åtgärdas med tilläggsanordningar. För mer information kan du kontakta oss direkt.
- RUS Управление различными продуктами DALI с помощью кнопки (напр.: Touch-dim, Switch-dim, Push-dim, Direct-dim и пр.) может вызвать проблемы синхронизации между ними. Эту проблему можно устранить путем задействования дополнительных устройств. За получением более подробной информации просим Вас связаться с нами непосредственно.
- CN 通过按钮控制不同的 DALI 产品 (例如: 触摸调光、切换调光、按压调光、直接调光等) 可能会导致产品的同步问题。该问题可通过使用其他额外的装置加以克服。如需了解更多信息, 请直接与我们联系。

DALI

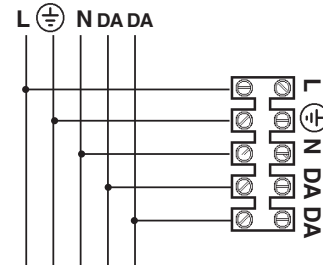

SWITCH DIM / TOUCH DIM

TRIDONIC - SWITCH DIM
OSRAM - TOUCH DIM
PHILIPS - TOUCH DIM

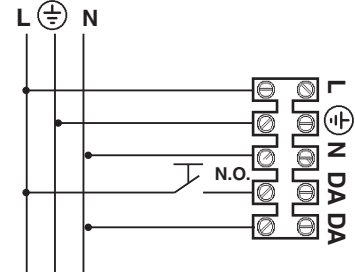

- I I dispositivi con cablaggio digitale possono essere dimmerati con dispositivi DALI o con pulsante normalmente aperto (N.O.) da collegare come da schema.
- GB Devices with digital control gear may be dimmed using DALI devices or a normally-open button (N.O.) to be connected as shown in the diagram.
- F Les articles à câblage numérique peuvent fonctionner avec des variateurs à dispositifs DALI ou à bouton poussoir normalement ouvert (N.O.) à relier conformément au schéma.
- D Die Geräte mit digitaler Verkabelung können mit Hilfe von DALI-Vorrichtungen oder mit Hilfe eines gemäß Schaltplan anzuschließenden Schließers (N.O.) gedimmt werden.
- NL De producten met digitale bekabeling kunnen worden gedimd met DALI systemen of met een N.O. (normally open) knop, die moet worden aangesloten volgens schema.
- E Los dispositivos con cableado digital pueden regularse con dispositivos DALI o con un interruptor de botón normalmente abierto (N.O.) que se conecta según ilustrado en el esquema.
- DK Produkter med digital kabelføring kan dæmpes med DALI-anordninger eller med kontakten, som normalt er åben (N.O.) og som skal tilsluttes, som vist.
- N Produkter med digitalkabler kan dimmes med DALI-anordninger eller med en normalt åpen (NO) trykkbryter som kobles som vist i koblingskjema.
- S Produkter med digital kabeldragnig kan föräses med dimmer. Detta kan göras med DALI-anordningarna eller med en normalt öppen kontakt (N.O.) som ska anslutas enligt schemat.
- RUS Интенсивность приборов с цифровой проводкой может регулироваться посредством устройств DALI или нормально разомкнутой кнопкой (Н.Р.), подсоединяемой согласно схеме.
- CN 带有数字控制装置的设备可以通过 DALI (数字化可寻址调光接口) 设备或者一个连接方式如图中所示的常开按钮 (N.O.) 进行亮度调节

TW

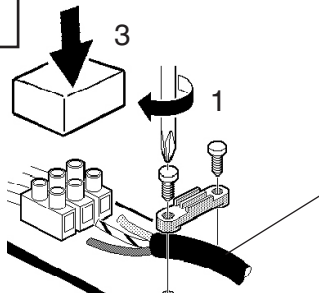

art. MB62 - MB63
MC15 - MC16

ALIMENTAZIONE
POWER SUPPLY
ALIMENTATION
EINSPEISUNG
STROOMVERZORGING
ALIMENTACION
STRØMFORSYNING
STRØMFORSYNING
ELFÖRSÖRNING
ЭЛЕКТРОПИТАНИЕ
电源

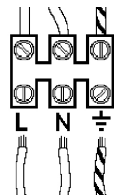
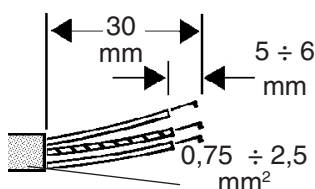

2

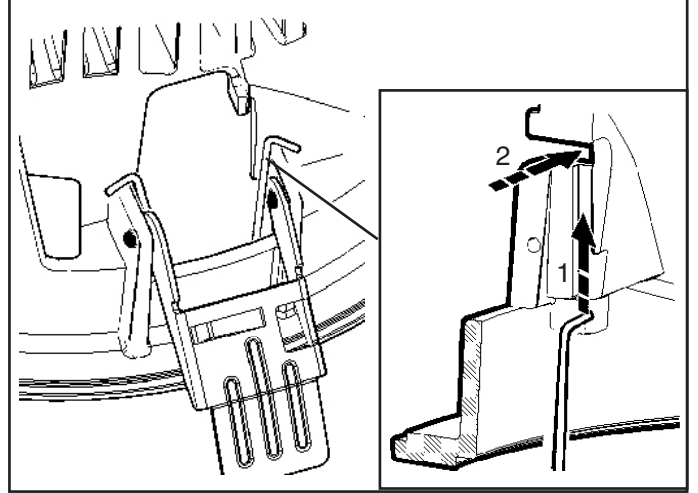
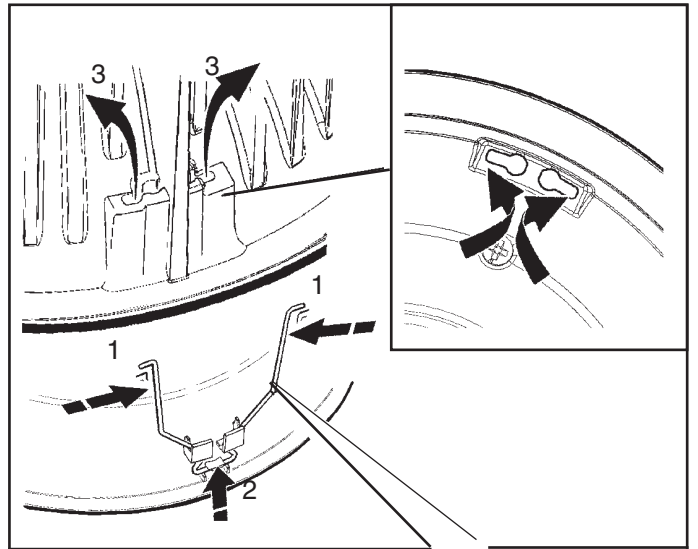

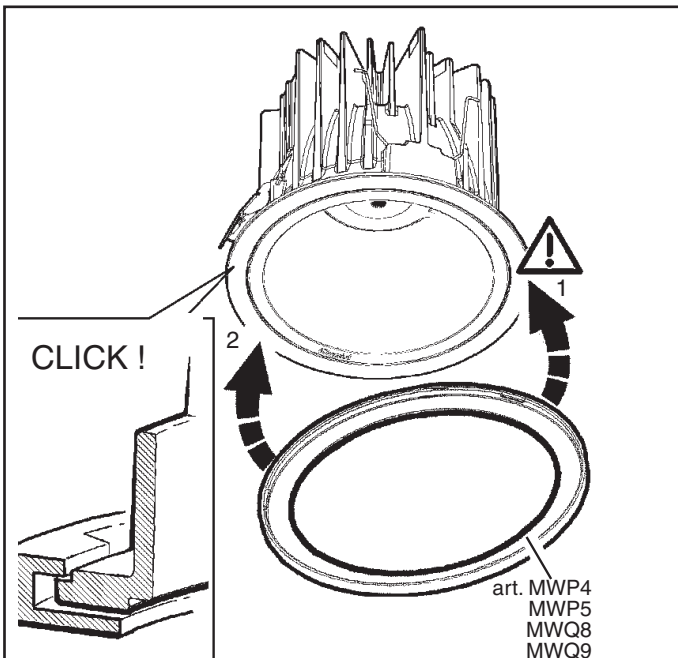
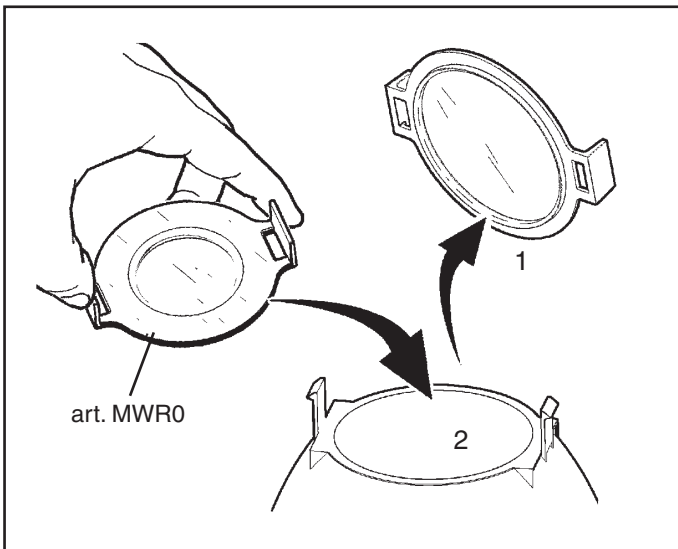
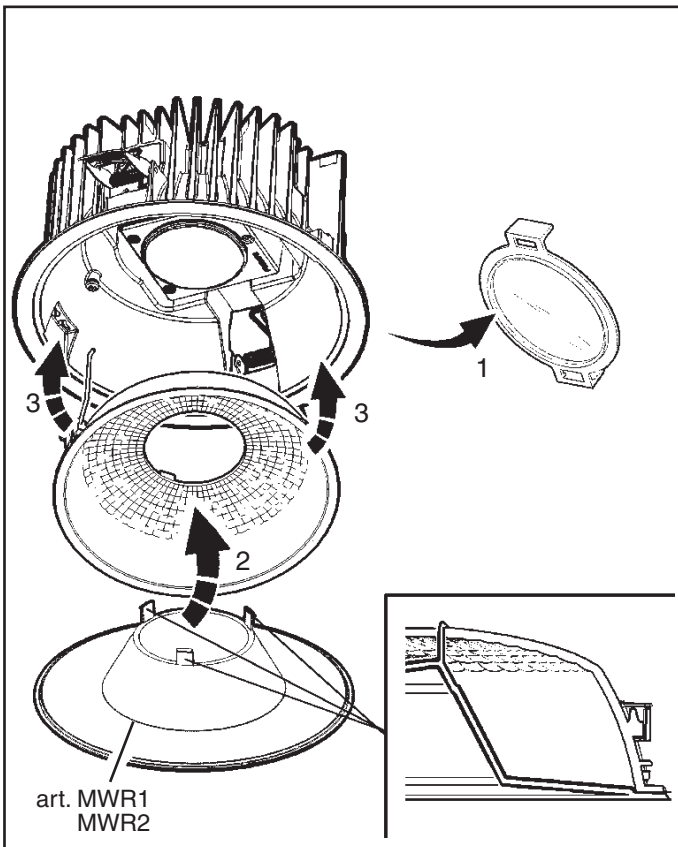

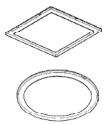
ART.	MWR0	MWR1	MWR2	
MB42 ->MB50	/	/	/	MWP4
MB52 ->MB59	●	●	●	MWP5
MB62 -> MB63	●	●	●	MWP5
MB66 -> MB91	●	/	/	MWP5
MB92 -> MB99	/	/	/	MWP5
MC00 -> MC03	/	/	/	MWQ8
MC05 -> MC12	●	/	/	MWQ9
MC19 -> MC36	●	/	/	MWQ9
MC15 - MC16	●	/	/	MWQ9
MC39 - MC40	●	●	●	MWP5
MC43 - MC44	/	/	/	MWP5
MC47 - MC48	●	/	/	MWQ9
MC04 - MC17 MC18 - MC60	/	/	/	MWP5
MU16 -> MU25	/	/	/	MWP4
MU26 -> MU30	/	/	/	MWQ8

I N.B.: Per la sostituzione del LED contattare l'azienda iGuzzini.
 GB N.B.: For information on LED replacement please contact iGuzzini.
 F N.B.: Pour procéder au remplacement de la LED, adressez-vous à la société iGuzzini.
 D Ñ.B.: Bezüglich des Austausches der LED kontaktieren Sie bitte die Firma iGuzzini.
 NL N.B.: Voor het vervangen van de LED neemt u contact op met het bedrijf iGuzzini.
 E NOTA: Para sustituir el LED llame a la empresa iGuzzini.
 DK N.B.: For udskiftning af lysdioden, skal man kontakte iGuzzini.
 N N.B.: For informasjon om skifte av LED, vennligst ta kontakt med iGuzzini.
 S OBS! För byte av lysdioden, kontakta företaget iGuzzini.
 RUS ПРИМЕЧАНИЕ: Для замены СИДов обращайтесь в компанию iGuzzini.
 CN 注意：如需LED更换的信息，请联系iGuzzini。

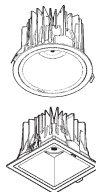
ART.	CARICO DALI / DALI LOAD CHARGE DALI (COURANT MAXI ADMISSIBLE) DALI-LAST DALI VERMOGEN CARGA DALI DALI STRÖMSTYRKE BELASTNING FOR "DALI" DALI-BELASTNING МАКС. ТОК СИСТЕМЫ DALI С РЕГУЛЯЦИЕЙ ИНТЕНСИВНОСТИ СВЕТА DALI 智能调光系统允许的最大电流量	INDIRIZZI DALI DALI ADDRESSES ADRESSES DALI DALI-ADRESSEN DALI ADRESSEN DIRECCIONES DALI DALI ADRESSER ADRESSER TIL "DALI" DALI-ADRESSER ЛОГИЧЕСКИЕ АДРЕСА СИСТЕМЫ DALI DALI智能调光系统计算机指定控制参数
	1	1

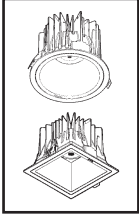

THE REFLEX EASY LED

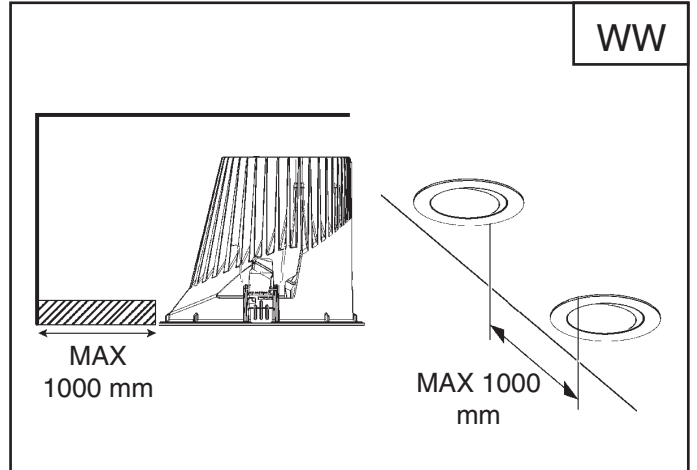
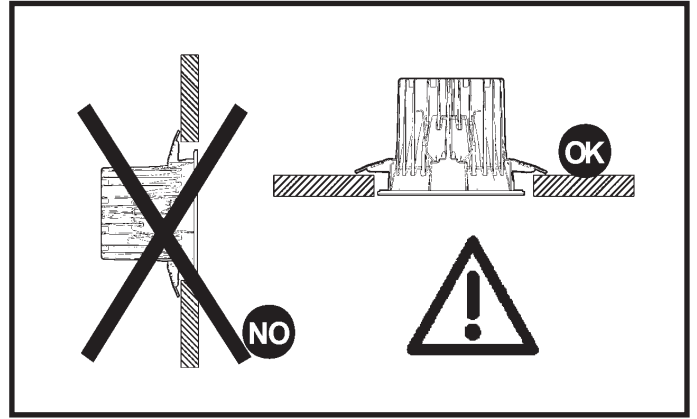

تحذير:

لا يمكن ضمان سلامة هذا الجهاز إلا إذا التزمت بهذه التعليمات. يجب حفظها في مكان آمن.

ATTENZIONE:

LA SICUREZZA DELL'APPARECCHIO E' GARANTITA SOLO CON L'USO APPROPRIATO DELLE SEGUENTI ISTRUZIONI; PERTANTO E' NECESSARIO CONSERVARLE.

WARNING:

THE SAFETY OF THIS FIXTURE IS GUARANTEED ONLY IF YOU COMPLY WITH THESE INSTRUCTIONS; REMEMBER TO CONSERVE IN A SAFE PLACE.

ATENCION:

LA SEGURIDAD DEL APARATO SE GARANTIZA SOLO CUMPLIENDO CUIDADOSAMENTE LAS SIGUIENTES INSTRUCCIONES; POR ELLO, ES NECESARIO CONSERVARLAS.

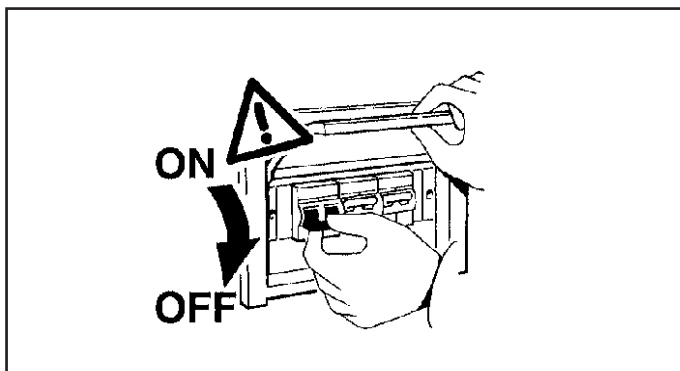
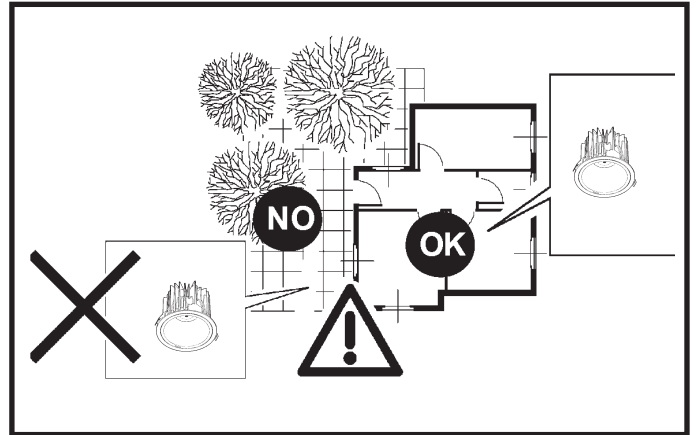

ملاحظة: ملاحظة: أثناء تركيب نظام بحرص بالنظم السائدة المتعلقة بالشبكة الكهربائية.

N.B.: DURANTE L'INSTALLAZIONE DEL SISTEMA RISPETTARE SCRUPolosAMENTE LE NORME IMPIANTISTICHE VIGENTI.

N.B.: WHEN INSTALLING THE SYSTEM STRICTLY COMPLY WITH ALL REGULATIONS ON INSTALLATION IN FORCE.

N.B.: DURANTE LA INSTALACIÓN DEL SISTEMA RESPETAR ESCRUPolosAMENTE LAS NORMAS DE INSTALACIÓN VIGENTES.

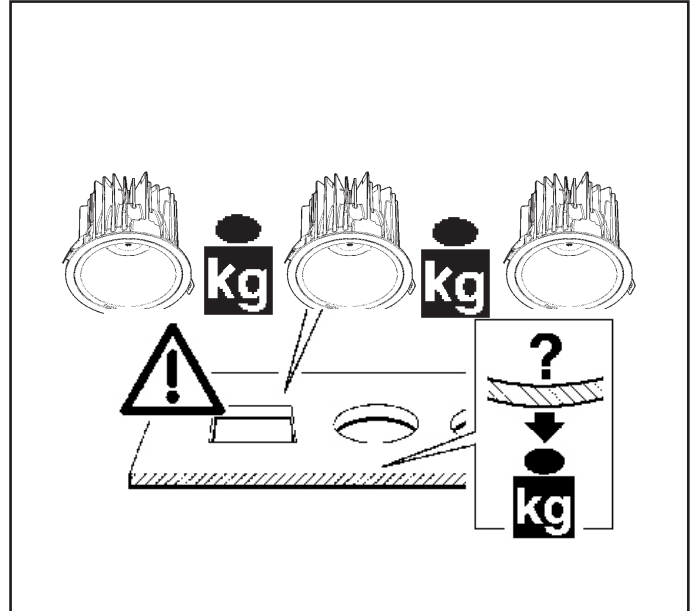

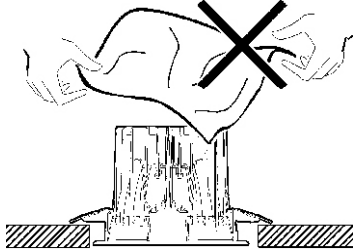
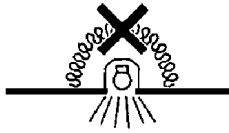

ملاحظة: أجهزة غير قابلة للتغطية بمواد عازلة حرارياً.

I N.B.: Apparecchi non idonei ad essere coperti di materiale termicamente isolante

GB N.B.: Fixtures not suitable to be covered in thermally-insulating material.

E OBS! Utrustningen får inte täckas över med värmeisolerande material

TW

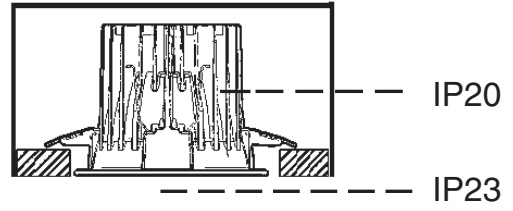

TW

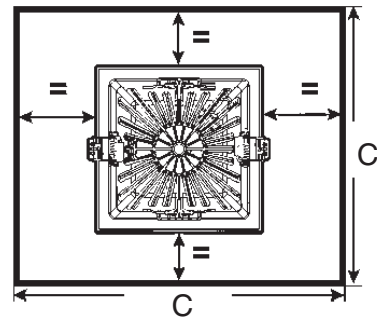

S

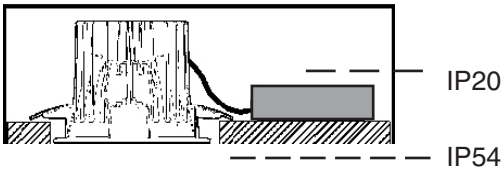

L

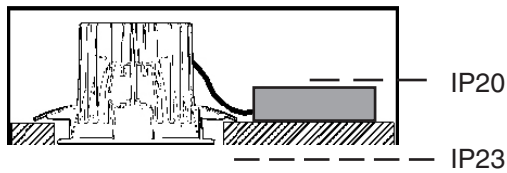

L

art. MC04 - MC17 - MC18 - MC60

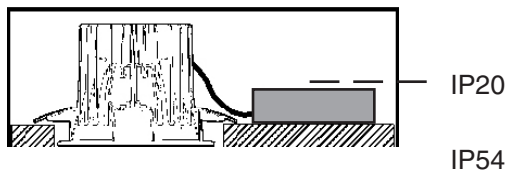

WW

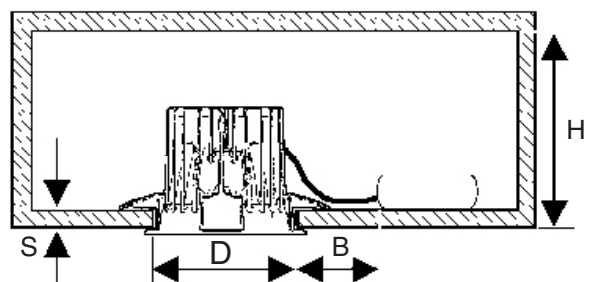
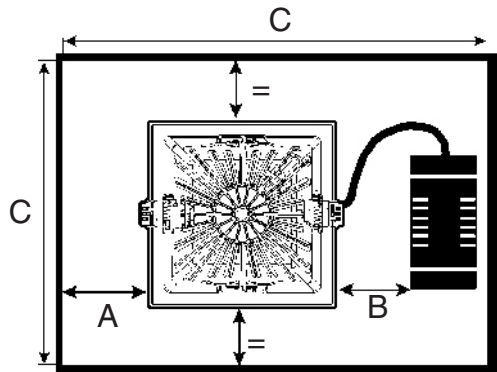
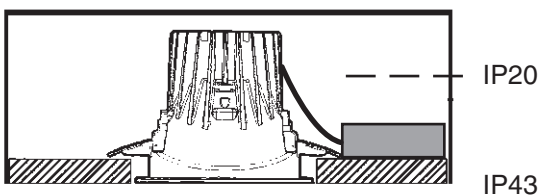

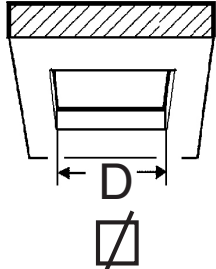
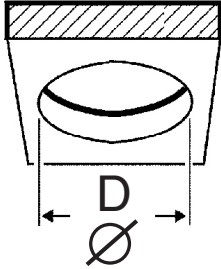

ART.	D mm	S mm	H mm	A mm	B mm	C mm		
MB42 - MB43 - MB44	∅ 125	1 ÷ 20	108	80	350			
MB45 - MU16 - MU17								
MU18 - MU19 - MU20								
MB47 - MB48 - MB49 - MB50 - MU21								
MU22 - MU23 - MU24								
MU25			150					
MC00 - MC01 - MC02 - MC03 - MU26	∇ 125		108					
MU27 - MU28 - MU29 - MU30	∇ 125							
MB82 - MB83	∅ 212	150		100	500			
MB84 - MB85				150	600			
MB86 - MB87				100	500			
MB88 - MB89				150	600			
MB92 - MB93				100	500			
MB94 - MB95				150	600			
MB96 - MB97				100	500			
MB98 - MB99				150	600			
MC27 - MC28			∇ 212	100		100	500	
MC29 - MC30						150	600	
MC31 - MC32		100			500			
MC33 - MC34		150			600			
MB52 - MB53 - MC39	∅ 212	1 ÷ 25	100	50	100	500		
MB54 - MB55 - MC40						150	600	
MB56 - MB57						100	500	
MB58 - MB59						150	600	
MB62 - MB63						150	600	
MB66 - MB67						100	500	
MB68 - MB69						150	600	
MB70 - MB71						100	500	
MB72 - MB73						150	600	
MB74 - MB75						100	500	
MB76 - MB77	∇ 212	100		150	600			
MB78 - MB79				100	500			
MB80 - MB81				150	600			
MC05 - MC06 - MC47				100	500			
MC07 - MC08 - MC48				150	600			
MC09 - MC10				100	500			
MC11 - MC12				150	600			
MC15 - MC16				150	600			
MC19 - MC20				100	500			
MC21 - MC22				150	600			
MC23 - MC24		100	500					
MC25 - MC26		150	600					
MC04 - MC17 - MC18 - MC60	∅ 212	180		150	600			
MC43				100	500			
MC44				150	600			

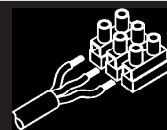
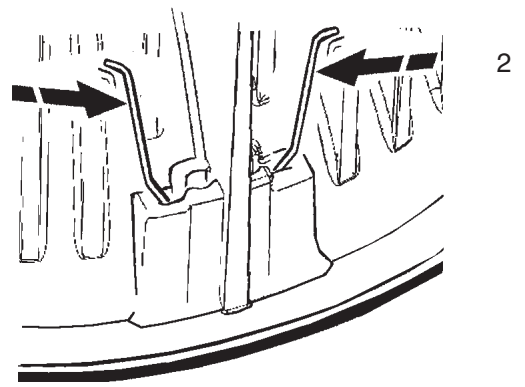
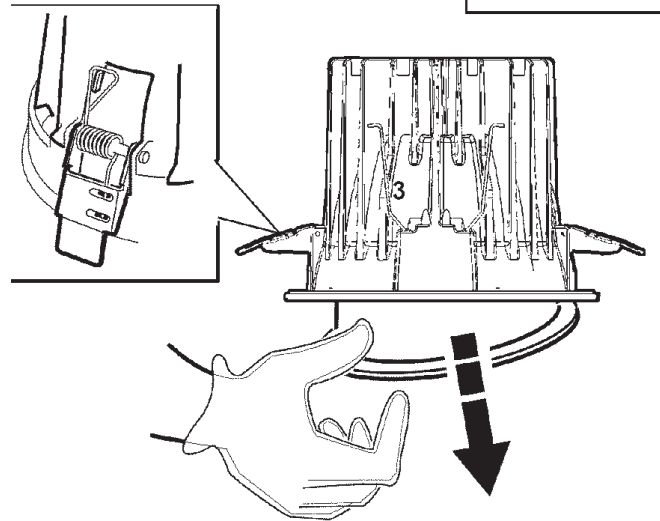
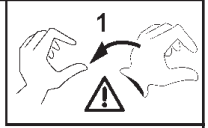

S / L / WW

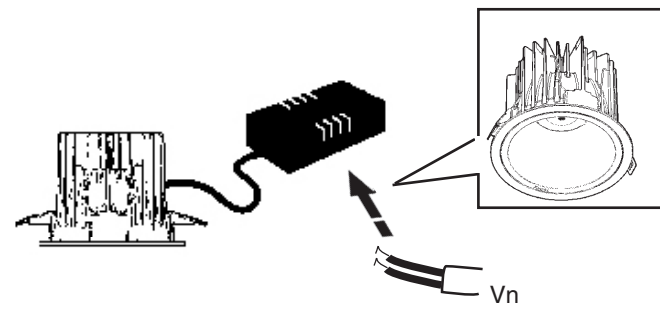

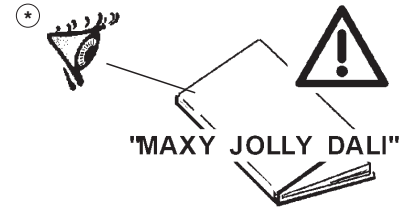

	S mm ² ملم ²	Y mm ملم	X mm ملم	D mm ملم
TRIDONIC	0,5 - 1,5	8,5 - 9,5	~ 40	/
OSRAM OT Fit		9 ± 0,5	~ 30	
OSRAM OT i DALI		8 - 9		7 - 11
PHILIPS Xitanium LH		9 ± 0,5	~ 25	
PHILIPS Xitanium SH	0,75 - 2,5	10 - 11	~ 40	/
PHILIPS Xitanium / m	0,2 - 1,5	8,5 - 9,5	~ 25	
GREE	0,75 - 2,5	10 - 11	~ 40	
* TCI DC MAXI JOLLY	0,5 - 2,5	6 ± 0,5	~ 30	3 - 8

للتوصيل بالكهرباء قم بالرجوع إلى العلامة المتواجدة على وحدة التغذية.

I Per il collegamento elettrico fare riferimento alla marcatura dell'alimentatore.

GB Refer to the marking on the power unit for the electrical connection.

E Para la conexión eléctrica hacer referencia a las informaciones marcadas en el alimentador.

يمكن أن يتسبب التحكم في منتجات "دالي" المختلفة عن طريق الأزرار ، (مثل الأزرار : "التش - ديم" ، "سويتش - ديم" ، "بوشر - ديم" ، دايكت - ديم" ، إلخ) ، في حدوث مشاكل تتعلق بعملية التزامن بين هذه الأزرار . وإن كان من الممكن تجنب مثل هذه المشاكل ، وذلك عن طريق تزويد بعض الأجهزة الإضافية بدعمك للاتصال المباشر بالشركة ، وذلك للحصول على أكبر قدر من المعلومات .

I Pilotare diversi prodotti DALI tramite pulsante (es: Touch-dim, Switch-dim, Push-dim, Direct-dim, etc.) potrebbe causare dei problemi di sincronizzazione tra gli stessi. È possibile ovviare a questo problema dotandosi di dispositivi aggiuntivi. Per maggiori informazioni vi invitiamo a contattarci direttamente.

GB Controlling different DALI products through buttons (e.g.: Touch-dim, Switch-dim, Push-dim, Direct-dim, etc.) may lead to product synchronisation problems. This problem can be overcome by using additional devices. For further information, please contact us directly.

E El mando de varios productos DALI por tecla (ej: Touch-dim, Switch-dim, Push-dim, Direct-dim, etc.) podría causar problemas de sincronización entre ellos. Es posible prevenir este problema utilizando dispositivos adicionales. Para más información, contacte directamente con nosotros.

DALI

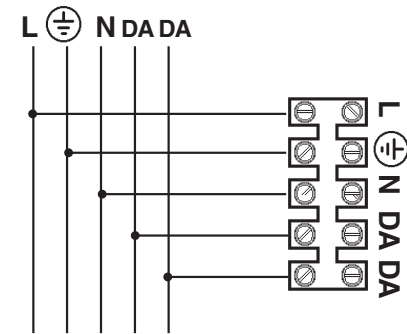

SWITCH DIM / TOUCH DIM

TRIDONIC - SWITCH DIM
OSRAM - TOUCH DIM
PHILIPS - TOUCH DIM

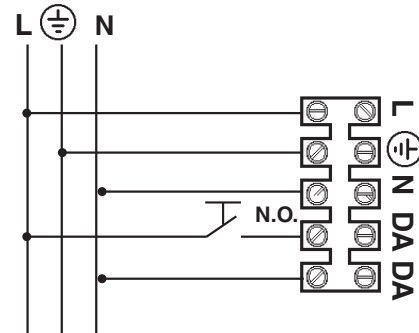

التجهيزات المزودة بكابلات رقمية يمكن وضع مخفضات لها بإضافة تجهيزات

DALI أو مفاتيح مضبوط على الوضع عامل عادة (N.O.) والذي يتم توصيله كما موضح في المخطط.

I I dispositivi con cablaggio digitale possono essere dimmerati con dispositivi DALI o con pulsante normalmente aperto (N.O.) da collegare come da schema.

GB Devices with digital control gear may be dimmed using DALI devices or a normally-open button (N.O.) to be connected as shown in the diagram.

E Los dispositivos con cableado digital pueden regularse con dispositivos DALI o con un interruptor de botón normalmente abierto (N.O.) que se conecta según ilustrado en el esquema.

TW

الصنف
art. MB62 - MB63
MC15 - MC16



2

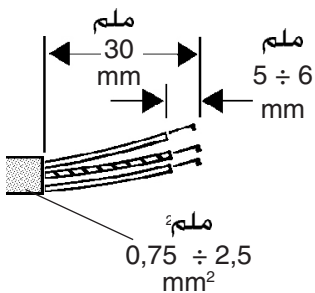

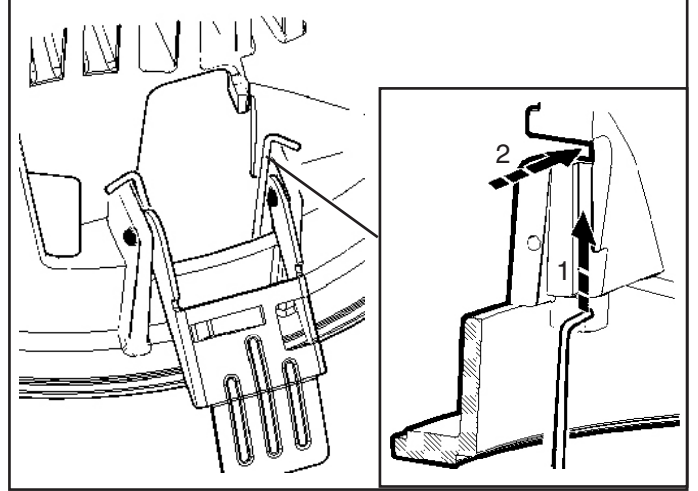
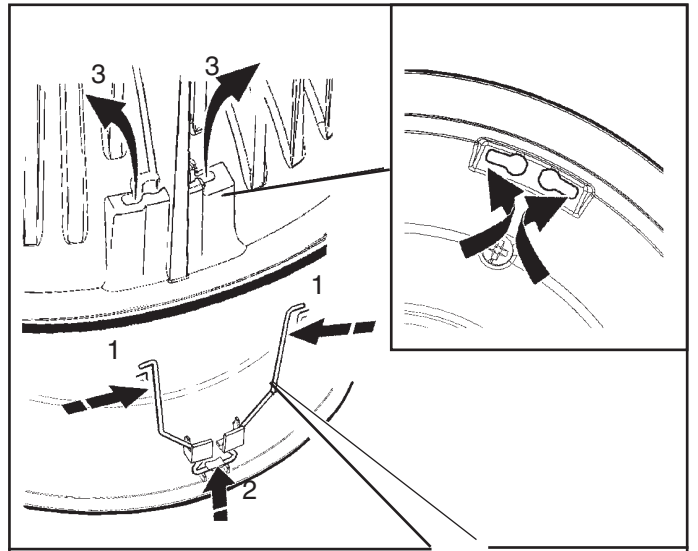

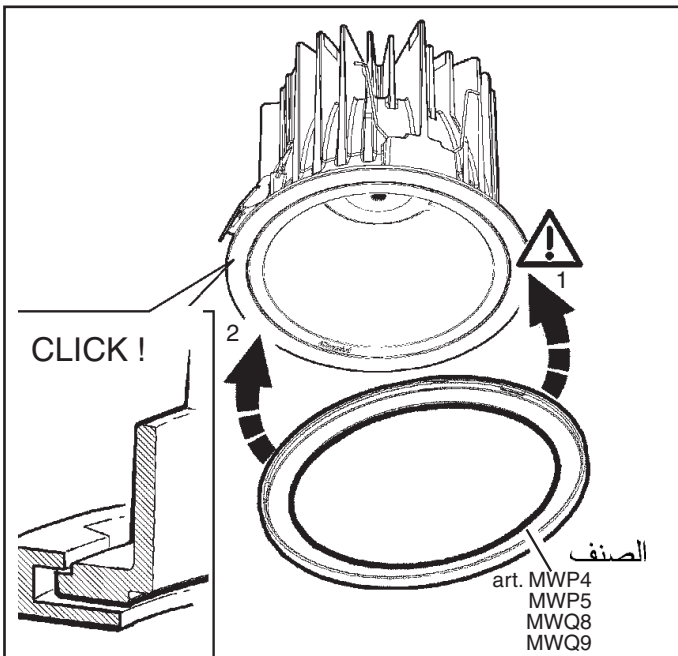
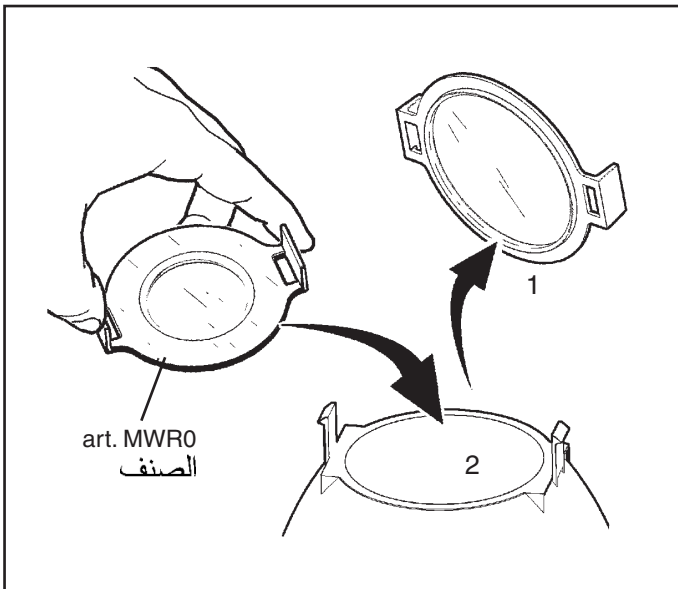

الصفن ART.	MWR0	MWR1	MWR2	
MB42 -> MB50	/	/	/	MWP4
MB52 -> MB59	●	●	●	MWP5
MB62 -> MB63	●	●	●	MWP5
MB66 -> MB91	●	/	/	MWP5
MB92 -> MB99	/	/	/	MWP5
MC00 -> MC03	/	/	/	MWQ8
MC05 -> MC12	●	/	/	MWQ9
MC19 -> MC36	●	/	/	MWQ9
MC15 - MC16	●	/	/	MWQ9
MC39 - MC40	●	●	●	MWP5
MC43 - MC44	/	/	/	MWP5
MC47 - MC48	●	/	/	MWQ9
MC04 - MC17 MC18 - MC60	/	/	/	MWP5
MU16 -> MU25	/	/	/	MWP4
MU26 -> MU30	/	/	/	MWQ8

استبدال الضوء

SOSTITUZIONE DEL LED
REPLACING THE LED
REEMPLAZO DEL LED

تنبیه: لاستبدال الضوء LED اتصل بشركة iGuzzini . عر

I N.B.: Per la sostituzione del LED contattare l'azienda iGuzzini.

GB N.B.: For information on LED replacement please contact iGuzzini.

E NOTA: Para sustituir el LED llame a la empresa iGuzzini.

1.154.588.05 ISO6067/15	iGuzzini	fattore di potenza power factor facteur de puissance Leistungsfaktor vermogensfactor factor de potencia effektfaktor effektfaktor effektfaktor фактор мощности 功率因数	corrente assorbita absorbed current courant absorbé Stromaufnahme stroomopname corriente absorbida absorberet strøm absorbert strøm tillförd ström поглощаемая мощность 电源电流
ART.		λ	A
MB42 - MB44 - MB47 - MB49 - MC00 - MC02		>0,9	0,06
MB43 - MB48 - MC01		>0,9	0,07
MB45 - MB50 - MC03		>0,95	0,07
MB52 - MB56 - MB60 - MB66 - MB70 - MB74 - MB78 - MB82 - MB86 - MB90 - MB92 - MB96 MC05 - MC09 - MC13 - MC19 - MC23 - MC27 - MC31 - MC35 - MU19 - MU24 - MU29		>0,95	0,1
MB53 - MB57 - MB61 - MB67 - MB71 - MB75 - MB79 - MB83 - MB87 - MB91 - MB93 - MB97 MC06 - MC10 - MC14 - MC20 - MC24 - MC28 - MC32 - MC36 - MU20 - MU25 - MU30		>0,95	0,11
MB54 - MB55 - MB58 - MB59 - MB68 - MB69 - MB72 - MB73 - MB76 - MB77 - MB80 - MB81 - MB84 - MB85 - MB88 - MB89 - MB94 - MB95 - MB98 - MB99 - MC07 - MC08 - MC11 - MC12 - MC21 - MC22 - MC25 - MC26 - MC29 - MC30 - MC33 - MC34		>0,95	0,15
MB63 - MC15 - MC16 - MC62		>0,9	0,09
MC39 - MC40 - MC43 - MC44 - MC47 - MC48		>0,95	0,16
MC04		>0,95	0,175
MC17		>0,95	0,182
MC18		>0,95	0,177
MC60		>0,95	0,185
MU16 - MU21 - MU26		>0,95	0,08
MU17 - MU18 - MU22 - MU23 - MU27 - MU28		>0,95	0,09

1.154.588.05 ISO6067/15	iGuzzini	fattore di potenza power factor facteur de puissance Leistungsfaktor vermogensfactor factor de potencia effektfaktor effektfaktor effektfaktor фактор мощности 功率因数	corrente assorbita absorbed current courant absorbé Stromaufnahme stroomopname corriente absorbida absorberet strøm absorbert strøm tillförd ström поглощаемая мощность 电源电流
ART.		λ	A
MB42 - MB44 - MB47 - MB49 - MC00 - MC02		>0,9	0,06
MB43 - MB48 - MC01		>0,9	0,07
MB45 - MB50 - MC03		>0,95	0,07
MB52 - MB56 - MB60 - MB66 - MB70 - MB74 - MB78 - MB82 - MB86 - MB90 - MB92 - MB96 MC05 - MC09 - MC13 - MC19 - MC23 - MC27 - MC31 - MC35 - MU19 - MU24 - MU29		>0,95	0,1
MB53 - MB57 - MB61 - MB67 - MB71 - MB75 - MB79 - MB83 - MB87 - MB91 - MB93 - MB97 MC06 - MC10 - MC14 - MC20 - MC24 - MC28 - MC32 - MC36 - MU20 - MU25 - MU30		>0,95	0,11
MB54 - MB55 - MB58 - MB59 - MB68 - MB69 - MB72 - MB73 - MB76 - MB77 - MB80 - MB81 - MB84 - MB85 - MB88 - MB89 - MB94 - MB95 - MB98 - MB99 - MC07 - MC08 - MC11 - MC12 - MC21 - MC22 - MC25 - MC26 - MC29 - MC30 - MC33 - MC34		>0,95	0,15
MB63 - MC15 - MC16 - MC62		>0,9	0,09
MC39 - MC40 - MC43 - MC44 - MC47 - MC48		>0,95	0,16
MC04		>0,95	0,175
MC17		>0,95	0,182
MC18		>0,95	0,177
MC60		>0,95	0,185
MU16 - MU21 - MU26		>0,95	0,08
MU17 - MU18 - MU22 - MU23 - MU27 - MU28		>0,95	0,09

2.509.266.04 IS06924/04  ART.	عامل القدر fattore di potenza power factor factor de potencia λ	التيار الممتص corrente assorbita absorbed current corriente absorbida A
MB42 - MB44 - MB47 - MB49 - MC00 - MC02	>0,9	0,06
MB43 - MB48 - MC01	>0,9	0,07
MB45 - MB50 - MC03	>0,95	0,07
MB52 - MB56 - MB60 - MB66 - MB70 - MB74 - MB78 - MB82 - MB86 - MB90 - MB92 - MB96 MC05 - MC09 - MC13 - MC19 - MC23 - MC27 - MC31 - MC35 - MU19 - MU24 - MU29	>0,95	0,1
MB53 - MB57 - MB61 - MB67 - MB71 - MB75 - MB79 - MB83 - MB87 - MB91 - MB93 - MB97 MC06 - MC10 - MC14 - MC20 - MC24 - MC28 - MC32 - MC36 - MU20 - MU25 - MU30	>0,95	0,11
MB54 - MB55 - MB58 - MB59 - MB68 - MB69 - MB72 - MB73 - MB76 - MB77 - MB80 - MB81 - MB84 - MB85 - MB88 - MB89 - MB94 - MB95 - MB98 - MB99 - MC07 - MC08 - MC11 - MC12 - MC21 - MC22 - MC25 - MC26 - MC29 - MC30 - MC33 - MC34	>0,95	0,15
MB63 - MC15 - MC16 - MC62	>0,9	0,09
MC39 - MC40 - MC43 - MC44 - MC47 - MC48	>0,95	0,16
MC04	>0,95	0,175
MC17	>0,95	0,182
MC18	>0,95	0,177
MC60	>0,95	0,185
MU16 - MU21 - MU26	>0,95	0,08
MU17 - MU18 - MU22 - MU23 - MU27 - MU28	>0,95	0,09

2.509.266.04 IS06924/04  ART.	عامل القدر fattore di potenza power factor factor de potencia λ	التيار الممتص corrente assorbita absorbed current corriente absorbida A
MB42 - MB44 - MB47 - MB49 - MC00 - MC02	>0,9	0,06
MB43 - MB48 - MC01	>0,9	0,07
MB45 - MB50 - MC03	>0,95	0,07
MB52 - MB56 - MB60 - MB66 - MB70 - MB74 - MB78 - MB82 - MB86 - MB90 - MB92 - MB96 MC05 - MC09 - MC13 - MC19 - MC23 - MC27 - MC31 - MC35 - MU19 - MU24 - MU29	>0,95	0,1
MB53 - MB57 - MB61 - MB67 - MB71 - MB75 - MB79 - MB83 - MB87 - MB91 - MB93 - MB97 MC06 - MC10 - MC14 - MC20 - MC24 - MC28 - MC32 - MC36 - MU20 - MU25 - MU30	>0,95	0,11
MB54 - MB55 - MB58 - MB59 - MB68 - MB69 - MB72 - MB73 - MB76 - MB77 - MB80 - MB81 - MB84 - MB85 - MB88 - MB89 - MB94 - MB95 - MB98 - MB99 - MC07 - MC08 - MC11 - MC12 - MC21 - MC22 - MC25 - MC26 - MC29 - MC30 - MC33 - MC34	>0,95	0,15
MB63 - MC15 - MC16 - MC62	>0,9	0,09
MC39 - MC40 - MC43 - MC44 - MC47 - MC48	>0,95	0,16
MC04	>0,95	0,175
MC17	>0,95	0,182
MC18	>0,95	0,177
MC60	>0,95	0,185
MU16 - MU21 - MU26	>0,95	0,08
MU17 - MU18 - MU22 - MU23 - MU27 - MU28	>0,95	0,09

- I Istruzioni per le operazioni di servizio per l'apparecchio di illuminazione**
GB Instructions on luminaire service operations
F Instructions pour les opérations de service du luminaire
D Wartungsanleitung für die Leuchte
NL Instructies voor de onderhoudsoperaties op de verlichtingsarmatuur
E Instrucciones para las operaciones de servicio del aparato de alumbrado
DK Anvisninger i serviceindgreb på belysningsarmatur
N Anvisninger for betjening av lysapparatet
S Instruktioner för användning av belysningsanordningen
RUS Инструкции по эксплуатации осветительного прибора
CN 照明装置检修操作说明

Sostituire la lampada parzialmente esausta
 Replace the partly exhausted lamp
 Remplacer la lampe partiellement épuisée
 Die teilweise erschöpfte Lampe austauschen
 Vervang de gedeeltelijk lege lamp
 Sustituir la lámpara parzialmente agotada
 Udskift den delvist udtjente pære
 Skifte ut den delvis utbrente lyspæren
 Byt ut den delvis förbrukade lampan
 Замена частично отработанной лампочки
 更换部分老化的灯泡



Spegnimento
 Switch it off
 Extinction
 Ausschaltung
 Uitschakeling
 Apagado
 Slukning
 Slukking
 Släckning
 Выключение
 关灯

Interrompere l'alimentazione dell'apparecchio
 Cut the power supply to the luminaire
 Couper l'alimentation du luminaire
 Stromversorgung der Leuchte unterbrechen
 Onderbreek de voeding van het apparaat
 Interrumpir la alimentación del aparato
 Afbryd armaturets strømforsyning
 Avbryt strømtilførselen til apparatet
 Koppla från anordningens strömförsörjning
 Отключить электропитание прибора
 中断装置供电



Aprire l'apparecchio
 Open the fixture
 Ouvrir le luminaire
 Das Gerät öffnen
 Open het apparaat
 Abrir el aparato
 Åbn armaturet
 Åpne apparatet
 Öppna anordningen
 Раскрыть прибор
 打开装置

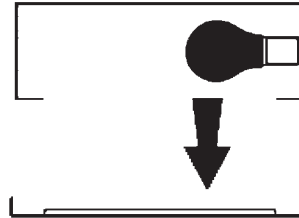

Rimuovere la lampada esausta
 Remove the exhausted lamp
 Retirer la lampe épuisée
 Die alte Lampe entnehmen
 Verwijder de lege lamp
 Quitar la lámpara agotada
 Tag den udtjente pære ud
 Fjerne den utbrente lyspæren
 Ta bort den förbrukade lampan
 Вынуть старую лампочку
 取出老化的灯泡

Portarla in un centro di riciclaggio
 Carry it to a recycling centre
 La porter dans une déchetterie pour son recyclage
 Ordnungsgemäß entsorgen
 Breng de lamp naar een recyclingcentrum
 Llevarla a un centro de reciclaje
 Aflever den på en genbrugsstation
 Lever den til en miljøstasjon
 Lämna in den till en återvinningsanläggning
 Сдать ее в пункт приема утильсырья
 将其送往回收中心

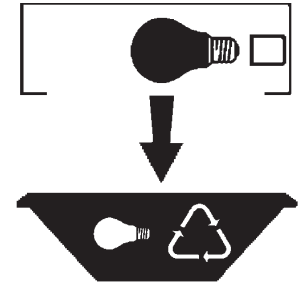

Inserire la nuova lampada
 Introduce the new lamp
 Installer la lampe neuve
 Die neue Lampe einsetzen
 Doe de nieuwe lamp op zijn plek
 Montar la nueva lámpara
 Sæt den nye pære i
 Sette i den nye pæren
 Sätt i den nya lampan
 Вставить новую лампочку
 装入新灯泡

Inserire la nuova lampada nel portalampada
 Fit the new lamp into the socket
 Installer la nouvelle lampe dans le support de lampe
 Die neue Lampe in den Sockel einsetzen
 Doe de nieuwe lamp in de lamphouder
 Montar la nueva lámpara en el portalámpara
 Sæt den nye pære i fatningen
 Sette den nye pæren inn i lampeholderen
 Sätt i den nya lampan i lamphållaren
 Вставить новую лампочку в патрон
 将新灯泡插入灯泡架中



Riposizionare ottica
 Re-place the optic
 Remettre l'optique à sa place
 Die Optik wieder einsetzen
 Doe de optiek weer op zijn plaats
 Volver a montar la óptica
 Sæt den optiske enhed på plads
 Innstille linsen
 Flytta om optiken
 Отрегулировать линзы
 重新定位光头



Effettuare prova di funzionamento
 Perform operative test
 Procéder à un essai de fonctionnement
 Eine Funktionsprüfung durchführen
 Controleer de correcte werking
 Hacer una prueba de funcionamiento
 Afprøv funktionen
 Prøve om den fungerer
 Utför funktionstest
 Выполнить проверку исправности работы
 执行功能测试



I Istruzioni per la pulizia dell'apparecchio di illuminazione
GB Instructions on luminaire cleaning operations
F Instructions pour le nettoyage du luminaire
D Anweisungen zur Reinigung der Leuchte
NL Instructies voor de reiniging van de verlichtingsarmatuur
E Instrucciones para limpiar el aparato de alumbrado
DK Anvisninger i rengøring af belysningsarmaturet
N Anvisninger for rengjøring av lysapparatet
S Instruktioner för rengöring av belysningsanordningen
RUS Инструкции по чистке осветительного прибора
CN 照明装置清洁说明

Pulire l'apparecchio
 Clean the fixture
Nettoyer le luminaire
 Das Gerät reinigen
Reinig het apparaat
 Limpiar el aparato
Rengør armaturet
Rengjøre apparatet
Rengör anordningen
 Чистка прибора
 清洁装置

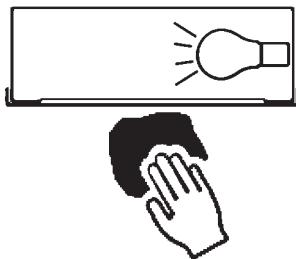

Spegnimento
 Switch it off
Extinction
Ausschaltung
Uitschakeling
Apagado
Slukning
Slukking
Släckning
Выключение
 关灯

Interrompere l'alimentazione dell'apparecchio
 Cut the power supply to the luminaire
 Couper l'alimentation du luminaire
 Stromversorgung der Leuchte unterbrechen
 Onderbreek de voeding van het apparaat
 Interrumpir la alimentación del aparato
 Afbryd armaturets strømforsyning
 Avbryt strømtilførselen til apparatet
 Koppla från anordningens strömförsörjning
 Отключить электропитание прибора
 中断装置供电



Spolverare l'ottica esterna
 Remove dust from the external optic
Dépoussiérer l'optique extérieure
Die externe Optik abstauben
Stof de externe optiek af
Quitar el polvo de la óptica exterior
Tør støvet af den udvendige optiske enhed
Fjerne støv fra den eksterne lysenheten
Damma av den yttre optiken
Вытереть пыль с внешней стороны линз
 为外侧光头掸尘



Lavare l'ottica esterna
 Wash the external optic
Laver l'optique extérieure
Die externe Optik waschen
Was de externe optiek
Lavar la óptica exterior
Vask den udvendige optiske enhed
Vaske den eksterne lysenheten
Rengör den yttre optiken
Вымыть линзы с внешней стороны
 清洁外光头



Rimuovere l'ottica
 Remove the optic
Retirer l'optique
Die Optik abnehmen
Verwijder de optiek
Quitar la óptica
Tag den optiske enhed af
Fjerne lysenheten
Ta bort optiken
Снять линзы
 取下光头



Pulire la parte interna dell'apparecchio di illuminazione
 Clean the inside of the fixture
Nettoyer l'intérieur du luminaire
Die Innenseite der Leuchte reinigen
Reinig de binnenzijde van de verlichtingsarmatuur
Limpiar el interior del aparato de alumbrado
Rengør belysningsarmaturets indvendige dele
Rengjøre lysapparatet innvendig
Rengör belysningsanordningen invändigt
Протереть осветительный прибор изнутри
 清洁照明装置内部



Riposizionare ottica
 Re-place the optic
Remettre l'optique à sa place
Die Optik wieder einsetzen
Doe de optiek weer op zijn plaats
Volver a montar la óptica
Sæt den optiske enhed på plads
Innstille linsen
Flytta om optiken
Отрегулировать линзы
 重新定位光头



Effettuare prova di funzionamento
 Perform operative test
Procéder à un essai de fonctionnement
Eine Funktionsprüfung durchführen
Controleer de correcte werking
Hacer una prueba de funcionamiento
Afprøv funktionen
Prøve om den fungerer
Utför funktionstest
Выполнить проверку исправности работы
 执行功能测试

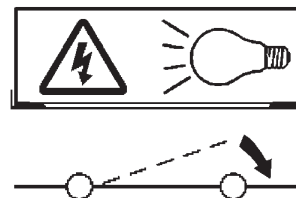

- I** Istruzioni per il fine vita e lo smaltimento dei componenti
GB Instructions on end-of-life and component disposal
F Instructions pour la gestion des composants en fin de vie et leur mise au rebut
D Anweisungen zur Entsorgung der Leuchtenkomponenten
NL Instructies voor het verwijderen van de armatuur en het recyclen van de onderdelen
E Instrucciones para el final de vida y la eliminación los componentes
DK Anvisninger i udtjent armatur og bortskaffelse af komponenter
N Anvisninger for endt levetid og avfallsbehandling av delene
S Instruktioner vid bortskaffning och kassering av komponenter
RUS Инструкции по утилизации прибора и его комплектующих по окончании его срока службы
CN 寿命期结束与零件废弃处置说明

<p>Spegnimento Switch it off Extinction Ausschaltung Uitschakeling Apagado Slukning Slukking Släckning Выключение 关灯</p> <p>Interrompere l'alimentazione dell'apparecchio Cut the power supply to the luminaire Couper l'alimentation du luminaire Stromversorgung der Leuchte unterbrechen Onderbreek de voeding van het apparaat Interrompirla alimentación del aparato Afbryd armaturets strømforsyning Avbryt strømtilførselen til apparatet Koppla från anordningens strömförsörjning Отключить электропитание прибора 中断装置供电</p> 	<p>Rimuovere la/e lampada/e per la dismissione Remove the lamp(s) for decommissioning Retirer la(les) lampe(s) pour sa(leur) mise au rebut Die Lampe/n ordnungsgemäß entsorgen Verwijder de lamp(en) voor het recyclen Quitar la(s) lámpara(s) para el desecho Tag pæren/pærerne ud til bortskaffelse Fjerne lampen/-e som skal kastes Ta bort lampan/-orna för bortskaffningen Вынуть лампочку/и для утилизации прибора 取出需要丢弃的灯泡</p> 	<p>Rimuovere la batteria per la dismissione Remove the battery for decommissioning Retirer la batterie pour sa mise au rebut Die Batterie ordnungsgemäß entsorgen Verwijder de batterij voor het recyclen Quitar la batería para el desecho Tag batteriet ud til bortskaffelse Fjerne batteriet som skal kastes Ta bort batteriet för bortskaffningen Вынуть батарейку для утилизации прибора 取出需要丢弃的电池</p> 	<p>Rimuovere l'apparecchio per la dismissione Remove the fixture for decommissioning Enlever le luminaire pour sa mise au rebut Das Gerät ordnungsgemäß entsorgen Verwijder het apparaat voor het recyclen Quitar el aparato para el desecho Tag armaturet ud til bortskaffelse Fjerne apparatet som skal kastes Ta bort anordningen för bortskaffningen Снять прибор для утилизации 取出需要丢弃的装置</p> 
---	--	--	--

<p>Inviare i materiali ad un centro di raccolta RAEE Send the materials to a WEEE collection centre Envoyer les matériaux dans une déchetterie DEEE Die Materialien in einem WEEE-Zentrum entsorgen Zend de materialen naar een recyclingscentrum voor de AEEA Enviar los materiales a un centro de recogida RAEE Afløver materialerne på et indsamlingscenter for elektronisk udstyr Sende materialene til en miljøstasjon for resirkulering av EE-avfall Skicka materialet till en RAEE uppsamlingscentral Сдать материалы в пункт приема утильсырья 将材料送往电气和电子垃圾回收中心</p> 			
--	--	--	--