

ISTRUZIONI PER L'INSTALLAZIONE DEL SISTEMA "PENCIL LED"
 INSTALLATION INSTRUCTIONS FOR "PENCIL LED" SYSTEM
 MODE D'INSTALLATION DU SYSTEME "PENCIL LED"
 HINWEISE ZUR INSTALLATION DER "PENCIL LED"
 INSTRUCTIES VOOR HET INSTALLEREN VAN HET "PENCIL LED"
 INSTRUCCIONES PARA LA INSTALACIÓN DEL SISTEMA "PENCIL LED"
 INSTALLATIONSVEJLEDNING TIL SYSTEMET "PENCIL LED"
 INSTALLASJONSANVISNING FOR SYSTEMET "PENCIL LED"
 INSTALLATIONSANVISNINGAR FÖR SYSTEM "PENCIL LED"
 ИНСТРУКЦИИ ПО МОНТАЖУ СИСТЕМЫ « PENCIL LED »
 " PENCIL LED "系统的安装说明

ATTENZIONE:

LA SICUREZZA DELL'APPARECCHIO E' GARANTITA SOLO CON L'USO APPROPRIATO DELLE SEGUENTI ISTRUZIONI; PERTANTO E' NECESSARIO CONSERVARLE.

WARNING:

THE SAFETY OF THIS FIXTURE IS GUARANTEED ONLY IF YOU COMPLY WITH THESE INSTRUCTIONS; REMEMBER TO CONSERVE IN A SAFE PLACE.

ATTENTION:

LA SECURITE DE L'APPAREIL N'EST GARANTIE QU'EN CAS D'UTILISATION CORRECTE DES INSTRUCTIONS SUIVANTES; IL FAUT PAR CONSEQUENT LES CONSERVER.

ACHTUNG:

DIE SICHERHEIT DES GERÄTES WIRD NUR DURCH SACHGEMÄSSE BEFOLGUNG NACHSTEHENDER ANWEISUNGEN GEWÄHRLEISTET; IHRE AUFBEWAHRUNG IST DESHALB SEHR WICHTIG.

ATTENTIE:

DE VEILIGHEID VAN DE APPARATUUR IS SLECHTS DAN GEGARANDEERD ALS MEN DE VOLGENDE INSTRUKTIES STRIKT OPVOLGT; DAAROM MOET MEN ZE OOK BEWAREN.

ATENCION:

LA SEGURIDAD DEL APARATO SE GARANTIZA SOLO CUMPLIENDO CUIDADOSAMENTE LAS SIGUIENTES INSTRUCCIONES; POR ELLO, ES NECESARIO CONSERVARLAS.

BEMÆRK:

SIKKERHEDEN VED BRUG AF ARMATURET KAN KUN GARANTERES, HVIS DISSE ANVISNINGER FØLGES; SØRG DERFOR FOR AT GEMME DEM.

ADVARSEL:

SIKKERHETEN TIL DETTE APPARATET GARANTERES KUN HVIS DU OVERHOLDER DISSE INSTRUKSJONENE; HUSK Å OPPBEVARE DEM PÅ ET TRYGT STED.

OBSERVERA!

UTRUSTNINGENS SÄKERHET KAN ENDAST GARANTERAS OM DESSA ANVISNINGAR RESPEKTERAS I DETALJ. SPARA DÄRFÖR DESSA ANVISNINGAR FÖR FRAMTIDA KONSULTATION.

ВНИМАНИЕ:

МЫ ГАРАНТИРУЕМ БЕЗОПАСНУЮ ЭКСПЛУАТАЦИЮ ИЗДЕЛИЯ ТОЛЬКО ПРИ СОБЛЮДЕНИИ СЛЕДУЮЩИХ ИНСТРУКЦИЙ; С ЭТОЙ ЦЕЛЬЮ НЕОБХОДИМО СОХРАНИТЬ ДАННУЮ БРОШЮРУ.

警告:

为确保该装置安全, 请遵守操作指示; 并于安全场所放置。

N.B.: DURANTE L'INSTALLAZIONE DEL SISTEMA "PENCIL" RISPETTARE SCRUPOLAMENTE LE NORME IMPIANTISTICHE NAZIONALI VIGENTI.

N.B.: WHEN INSTALLING THE "PENCIL" SYSTEM, MAKE SURE ALL CURRENT NATIONAL REGULATIONS RELATING TO INSTALLATION ARE OBSERVED.

N.B.: LORS DE L'INSTALLATION DU SYSTÈME "PENCIL" VEUILLEZ RESPECTER RIGOREUSEMENT LES NORMES EN VIGUEUR EN LA MATIÈRE DANS LE PAYS.

N.B.: BEACHTEN SIE BEI DER INSTALLATION DES SYSTEMS "PENCIL" UNBEDINGT DIE IM LAND GELTENDEN ANLAGETECHNISCHEN VORSCHRIFTEN.

N.B.: BIJ HET INSTALLEREN VAN HET "PENCIL" SYSTEEM MOET U DE GELDENDE NATIONALE INSTALLATIENORMEN STRIKT NALEVEN.

NOTA: DURANTE LA INSTALACIÓN DEL SISTEMA "PENCIL" RESPETAR ESCRUPULOSAMENTE LAS NORMAS NACIONALES DE INSTALACIÓN EN VIGOR.

N.B.: UNDER INSTALLATION AF "PENCIL" SYSTEMET SKAL MAN NØJE OVERHOLDE DE GÆLDENDE REGLER FOR DISSE ANLÆG.

N.B.: UNDER INSTALLASJON AV SYSTEMET "PENCIL" MÅ DE NASJONALE ANLEGGSFORSKRIFTE OVERHOLDES NØYE.

OBS! UNDER INSTALLATIONEN AV SYSTEMET "PENCIL" SKA GÄLLANDE NATIONELLA INSTALLATIONSFÖRESKRIFTER RESPEKTERAS I DETALJ.

ПРИМЕЧАНИЕ: В ПРОЦЕССЕ МОНТАЖА СИСТЕМЫ " PENCIL " СТРОГО СОБЛЮДАЙТЕ НАЦИОНАЛЬНЫЕ ДЕЙСТВУЮЩИЕ НОРМАТИВЫ ПО ЭЛЕКТРОПРОВОДКЕ.

注意: 在安装 " PENCIL " 系统时请遵守设备的安装规定。

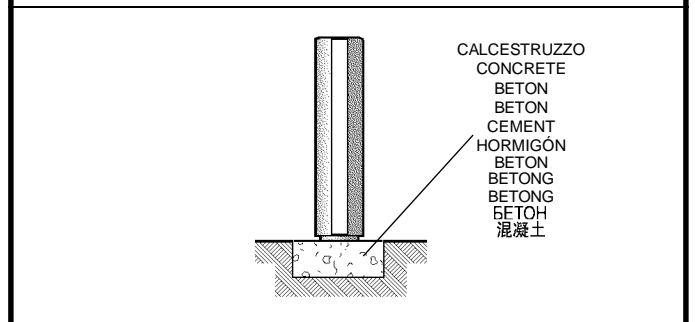
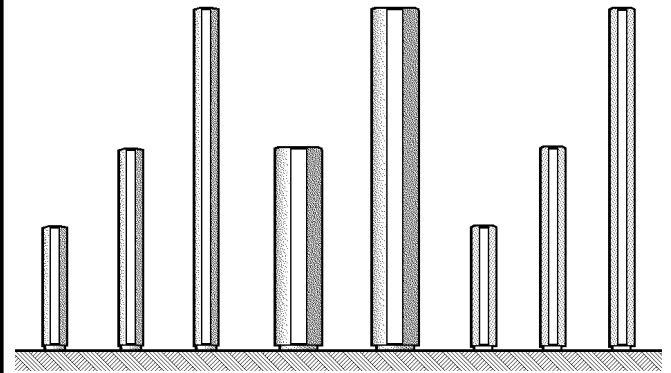
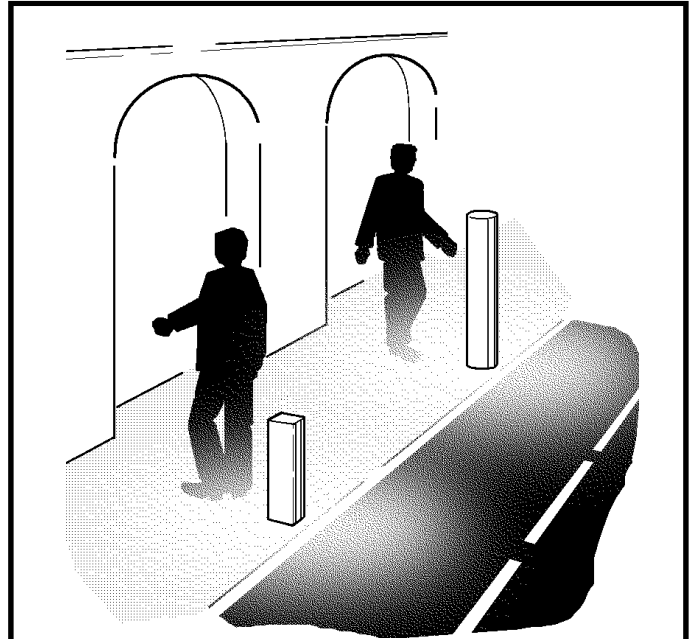

I N.B.: Installando l'apparecchio, evitare che la base venga interrata o posizionata in punti soggetti al ristagno dell'acqua.

GB N.B.: Whilst installing the appliance, avoid concealing its base or placing it in areas which are susceptible to damp.

F N.B.: Lors de l'installation de l'appareil, veillez à ce que la base ne soit pas enterrée ou positionnée dans un endroit sujet à la stagnation de l'eau.

D N.B.: Bei der Installation des Gerätes ist darauf zu achten, daß das Unterteil nicht eingegraben oder an Stellen placiert wird, an denen sich Wasser stauen könnte.

NL N.B.: Het apparaat mag niet met de basis ingebouwd worden of op punten geïnstalleerd die stilstaand water veroorzaken.

E NOTA: Al instalar el aparato, evite que la base se entierre o se coloque en puntos donde se pueda estancar el agua.

DK N.B.: Ved installation af armaturet skal man undgå, at soklen er under niveau eller placeres på et sted, hvor der ophobes vand.

N N.B.: Under installasjon av apparatet, unngå å skjule basen eller plassere den på områder som er utsatt for damp.

S OBS! När utrustningen installeras ska du undvika att basen hamnar under marken eller placeras på ställen där vatten ansamlas.

RUS ПРИМЕЧАНИЕ: При монтаже прибора следует избегать зарывания в почву или установку в точках, подверженных затоплению.

CN 注意: 安装该灯具时, 避免隐藏底座或将灯具放置在易受潮的区域。

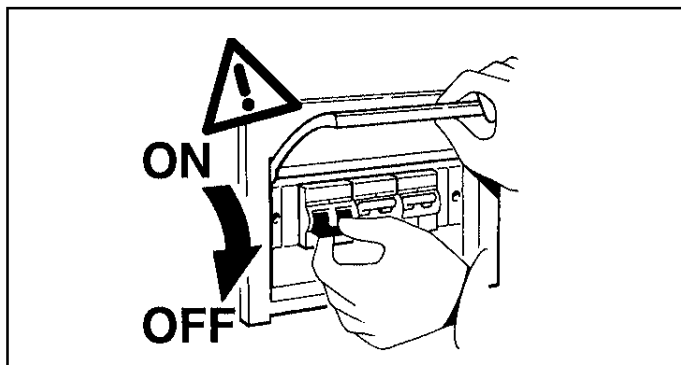

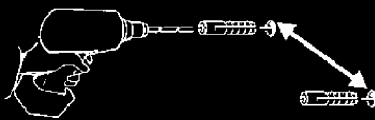

LATO PEDONALE O CARRABILE
 PEDESTRIAN OR VEHICULAR SIDE
 CÔTÉ PIÉTONS OU VOITURES
 FUSSGÄNGER- ODER FAHRWEGSEITE
 VOETGANGERSZIJDE OF BERIJDBARE ZIJDE
 LADO PEATONAL O VEHICULAR
 GANGSTI ELLER KØ REBANE
 FOTGJENGER- ELLER KJØ RETØ YSIDE
 SIDA FÖR FOTGÄNGARE ELLER FORDON
 ПЕШЕХОДНАЯ ИЛИ ПРОЕЗЖАЯ СТОРОНА
 行人或机动车辆侧

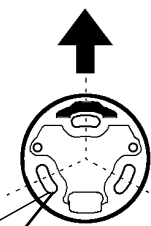

art. BN34
 BN35
 BN37

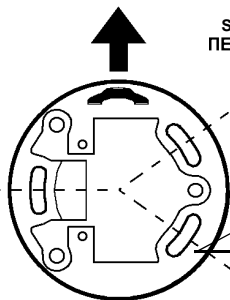

art. BN36
 BN38

art. BN39 - BN40
 BN41 - BN42
 BN94

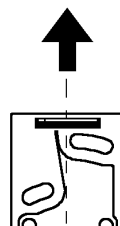

PER IL FISSAGGIO SI CONSIGLIA DI UTILIZZARE TASSELLI PER ANCORAGGI PESANTI TIPO FZA-I-M 6 ÷ 8 FISCHER, O SIMILARI ANCHE DI ALTRI COSTRUTTORI.
 FOR FIXING USE HEAVY DUTY PLUGS, SUCH AS FZA-I-M 6 ÷ 8 FISCHER OR SIMILAR, INCLUDING FROM OTHER MANUFACTURERS.
 POUR LA FIXATION, IL EST CONSEILLÉ D'UTILISER DES CHEVILLES POUR ANCRAGES LOURDS DE TYPE FZA-I-M 6 ÷ 8 FISCHER OU SIMILAIRES (D'AUTRES FABRICANTS AUSSI).
 ZUR BEFESTIGUNG EMPFEHLEN WIR, STARKE VERANKERUNGSDÜBEL ZU VERWENDEN, ZUM BEISPIEL VOM TYP FZA-I-M 6 ÷ 8 VON FISCHER ODER ENTSPRECHENDE PRODUKTE VON ANDEREN HERSTELLERN.
 VOOR DE BEVESTIGING RADEN WIJ U AAN PLUGGEN VOOR ZWARKE VERANKERINGEN TE GEBRUIKEN, ZOALS HET TYPE FZA-I-M 6 ÷ 8 FISCHER OF DERGELIJKE, OOK VAN ANDERE PRODUCTENTEN.
 PARA LA FIJACIÓN SE RECOMIENDA UTILIZAR TACOS PARA ANCLAJES DE GRAN RESISTENCIA, TIPO FZA-I-M 6 ÷ 8 FISCHER, O SIMILARES, INCLUSO DE OTROS FABRICANTES.
 VED MONTERING ANBEFALES BRUG AF RAWLPLUGS TIL TUNGE EMNER AF TYPEN FZA-I-M 6 ÷ 8 FISCHER, ELLER LIGNENDE FRA ANDRE FABRIKANTER.
 FOR FESTE BRUKES HØ YYTELSESLER PLUGGER, SLIK SOM FZA-I-M 6 ÷ 8 FISCHER ELLER LIGNENDE, INKLUDERT FRA ANDRE PRODUSENTER.
 FÖR FASTSÄTTNINGEN REKOMMENDERAS ATT ANVÄNDA PLUGGAR FÖR FASTSÄTTNING AV TYNGRE FÖREMÅL AV TYP FZA-I-M 6 - 8 FISCHER, ELLER LIKANDE AV ANNAT MÄRKE.
 ДЛЯ КРЕПЛЕНИЯ РЕКОМЕНДУЕТСЯ ИСПОЛЬЗОВАТЬ ВКЛАДЫШИ ДЛЯ ТЯЖЕЛОГО КРЕПЛЕНИЯ ТИПА FZA-I-M 6 ÷ 8 FISCHER ИЛИ ПОДОБНЫЕ ДРУГИХ МАРОК.
 进行固定时，使用大载流插头，例如FZA-I-M 6 ÷ 8 FISCHER 或SIMILAR，也包括其他生产商提供的插头。

ART.	V (mm)
BN34 - BN35 - BN37	M 6
BN36 - BN38 - BN39 - BN40 BN41 - BN42 - BN94	M 8

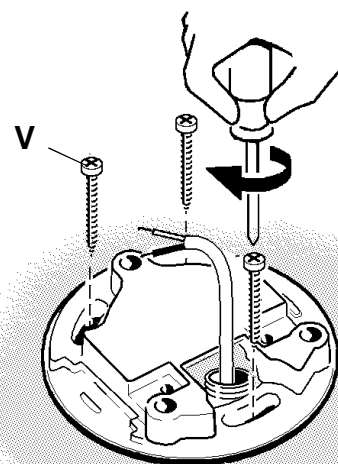
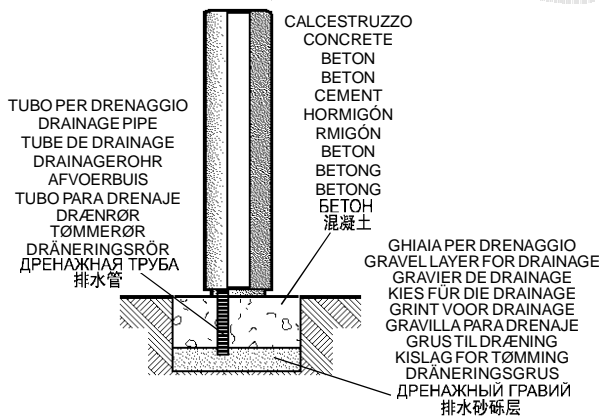
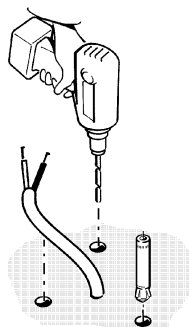
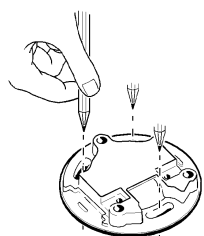



art. B515 - B516 - B517

LATO PEDONALE O CARRABILE
 PEDESTRIAN OR VEHICULAR SIDE
 CÔTÉ PIÉTONS OU VOITURES
 FUSSGÄNGER- ODER FAHRWEGSEITE
 VOETGANGERSZIJDE OF BERIJDBARE ZIJDE
 LADO PEATONAL O VEHICULAR
 GANGSTI ELLER KØ REBAN
 FOTGJENGER- ELLER KJØ RETØ YSIDE
 SIDA FÖR FOTGÄNGARE ELLER FORDON
 ПЕШЕХОДНАЯ ИЛИ ПРОЕЗЖАЯ СТОРОНА
 行人或机动车侧

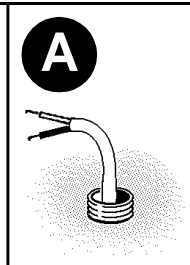
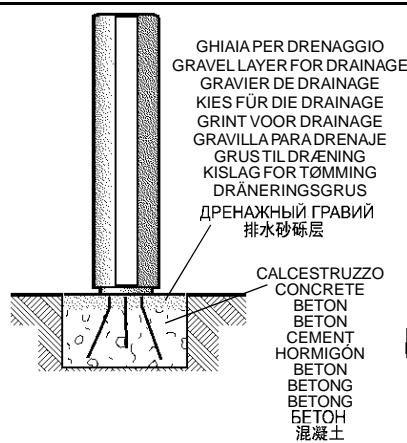
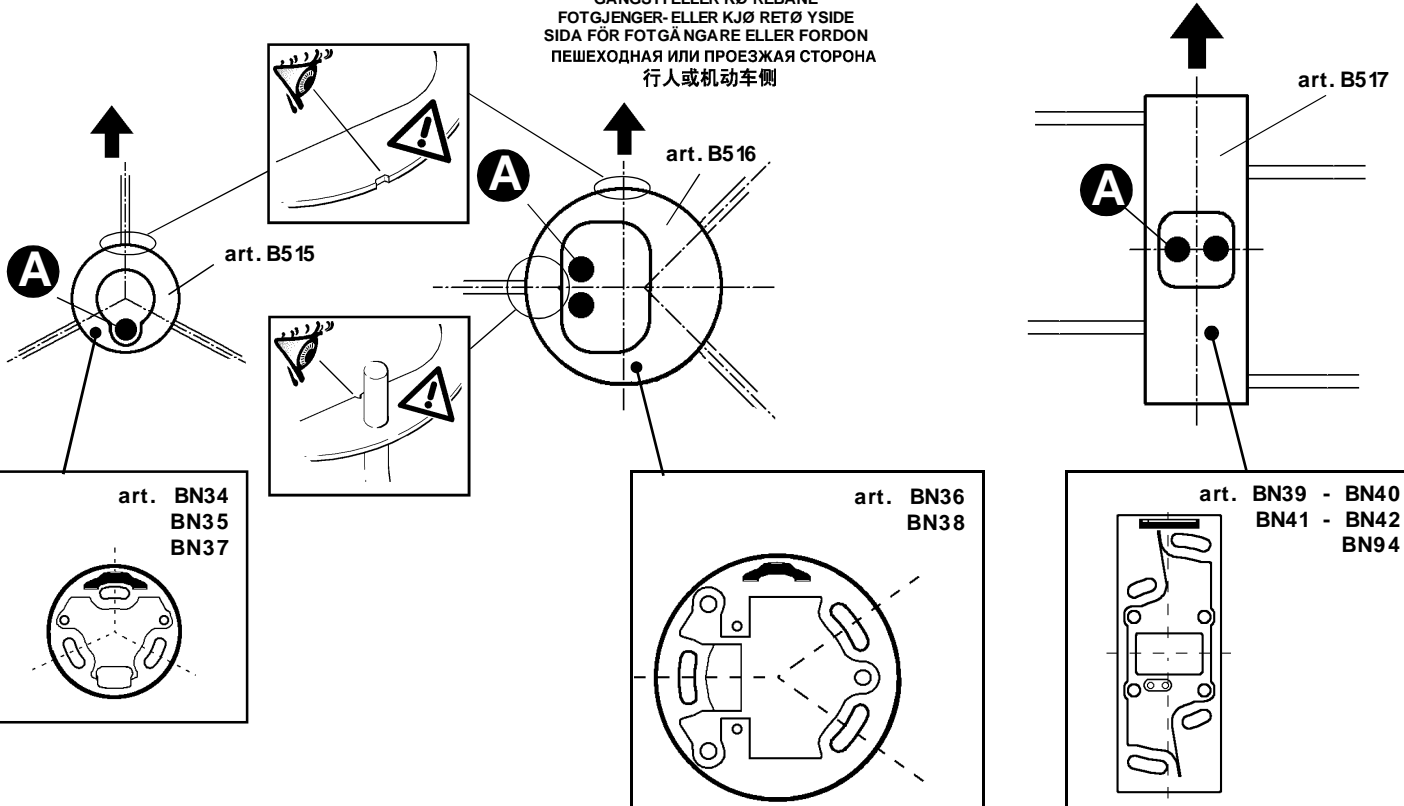

ART.	art.	B min (mm)
BN34 - BN35 - BN37	B515	-
BN36 - BN38	B516	254
BN39 - BN40 - BN41 - BN42 BN94	B517	190 254

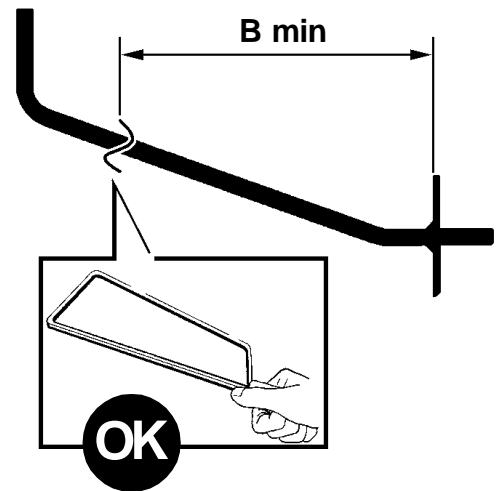
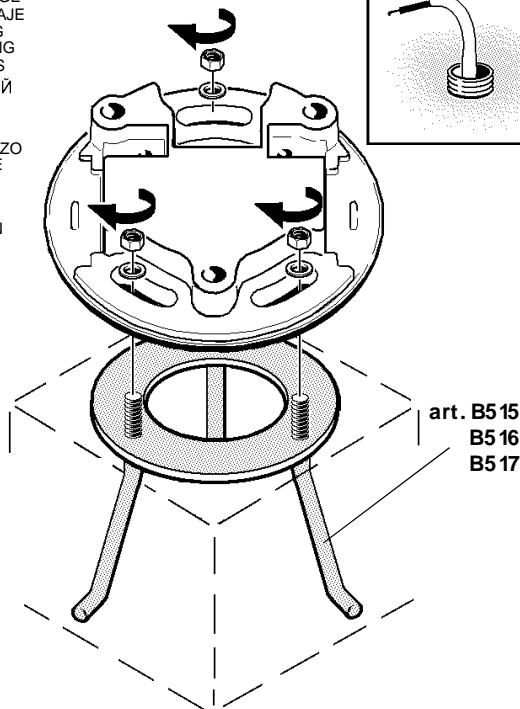

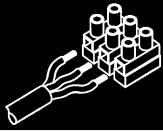

- I Per il cablaggio elettrico utilizzare cavi con doppio isolamento.
- GB** Use cable with double insulation for the electric wiring.
- F** Pour le câblage électrique, utiliser des câbles à double isolation.
- D** Für die elektrische Verdrahtung sind Kabel mit Mantel zu verwenden.
- NL** Gebruik dubbel-geïsoleerde kabels voor de elektrische aansluiting.
- E** Para el cableado eléctrico servirse de cables con doble aislamiento.
- DK** De anvendte ledninger skal have dobbelt isolering.
- N** Bruk kabel med dobbelt isolasjon til elektrisk kabling.
- S** Använd elkablar med dubbel isolering för kabeldragningen.
- RUS** Для монтажа кабелепроводки используйте провода с двойной изоляцией.
- CN** 针对架线，使用双重绝缘的电缆。

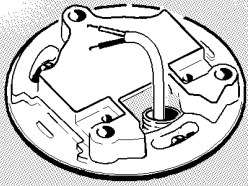

CABLAGGIO PASSANTE
FEEDTHROUGH WIRING
CABLAGE TRAVERSANT
DURCHGANGSKABEL
KABELDOORGANG
CABLEADO PASANTE
GENNEMGÅENDE LEDNINGER
FØRINGSKABLING
KABELGENOMFØRING
СКВОЗНОЙ МОНТАЖ
连接线架设

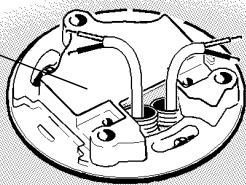

- I **N.B.:** Per il collegamento elettrico alla rete, servirsì dell'art. **B512** o di altri dispositivi di connessione in classe II che garantiscano il grado di protezione IP66.
- GB N.B.:** To connect to the mains, use art. **B512** or other class II connection devices which guarantee an IP66 degree of protection.
- F N.B.:** Pour le raccordement électrique, à la ligne, servez-vous de l'art. **B512** ou d'autres dispositifs de connexion Classe II garantissant l'indice de protection IP66.
- D N.B.:** Der Anschluß, an das Stromnetz ist mittels des Artikels **B512** oder anderen, Anschlußvorrichtungen der Klasse II, die den Schutzgrad IP66 gewährleisten, vorzunehmen.
- NL N.B.:** Voor de elektrische aansluiting aan het net maakt u gebruik van art. **B512** of andere aansluitingssystemen in klasse II die de protektiegraad IP66 garanderen.
- E NOTA:** Para conexión eléctrica a la red, utilizar e art. **B512** u otros dispositivos de conexión en clase II, para garantizar grado de protección IP66.
- DK N.B.:** For elektrisk tilslutning til forsyningsnettet skal man bruge art. **B512** eller en anden forbindelsesanordning i klasse II, der garanterer en beskyttelsesgrad lig med IP66.
- N N.B.:** For å gj r elektriske tilkoplinger til str mmettet, bruk artikkel **B512** eller andre tilkoplingsinnretninger i klasse som garanterer en IP66 beskyttelsesgrad.
- S OBS!** F r anslutningen till eln tet, anv nd art. **B512** eller andra anslutningsanordningar i klass II som garanterar skyddsgrad IP66.
- RUS ПРИМЕЧАНИЕ:** Для подключения к электрической сети используйте артикуль **B512** или другие соединительные устройства класса II, обеспечивающие класс электробезопасности IP 66.
- CN 注意:** 为实现与干线的电路连接，使用art. B512或其他可保证IP66保护度的II级连接装置。接线排须是带螺丝夹钳(2.5 mm² max.)的类型，适用于250V供应电压和6A额定电流。

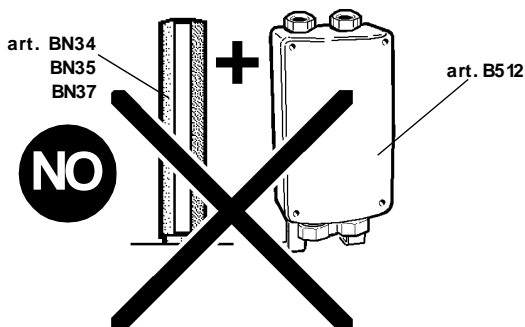

- I In caso di danneggiamento del cavo flessibile esterno, questo deve essere sostituito dal costruttore, o dal suo servizio di assistenza, o da personale qualificato equivalente, al fine di evitare pericoli.
- GB** Should the outer flexible cable be somehow damaged, the latter should be replaced by the manufacturer, or by the corresponding service centre, or by an appropriate and qualified member of staff in order to avoid all risk of danger.
- F** Si le câble flexible extérieur est abîmé, faites-le remplacer par le fabricant, par son service après-vente ou par un professionnel du secteur agréé afin d'éviter tout danger.
- D** Sollte das  u ere Kabel besch digt sein, so muss es aus Sicherheitsgr nden vom Hersteller, dessen Kundendienst oder von dazu autorisiertem Personal ausgewechselt werden.
- NL** Mocht de externe flexibele slang beschadigd worden, dan moet deze worden vervangen door de fabrikant of door een bevoegde installateur, zodat eventueel gevaar vermeden wordt.
- E** En caso de da os el cable flexible externo debe substituirse por el fabricante, su servicio de asistencia o personal calificado equivalente para evitar peligros.
- DK** Hvis den yderste ledning beskadiges, skal den udskiftes af producenten eller et autoriseret teknisk servicecenter, eller af kvalificerede fagfolk, s  man undg r farlige situationer.
- N** Hvis ytre fleksible kabel skulle bli skadet, skal denne skiftes ut av produsenten eller tilsvarende servicecenter eller av en egnet og kvalifisert fagperson for   unng  farerisiko.
- S** Om den yttre kabeln skadas ska den bytas ut av tillverkaren, av dess auktoriserade verkstad eller av likv rdig kvalificerad personal f r att undvika alla typer av risker.
- RUS** В случае повреждения внешнего гибкого кабеля во избежание риска поручите его замену производителю, уполномоченному сервису или квалифицированному электрику.
- CN** 如果外部软缆损坏，须由生产商、对应服务中心或能胜任和资深的员工更换新的电缆，以避免任何可能的危险。

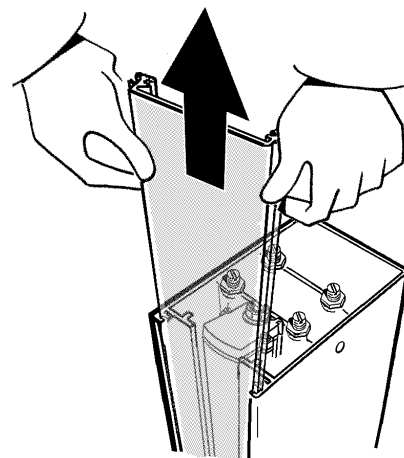
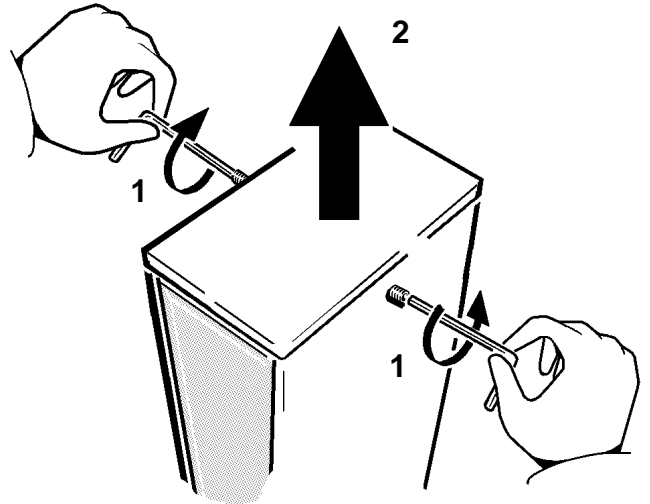

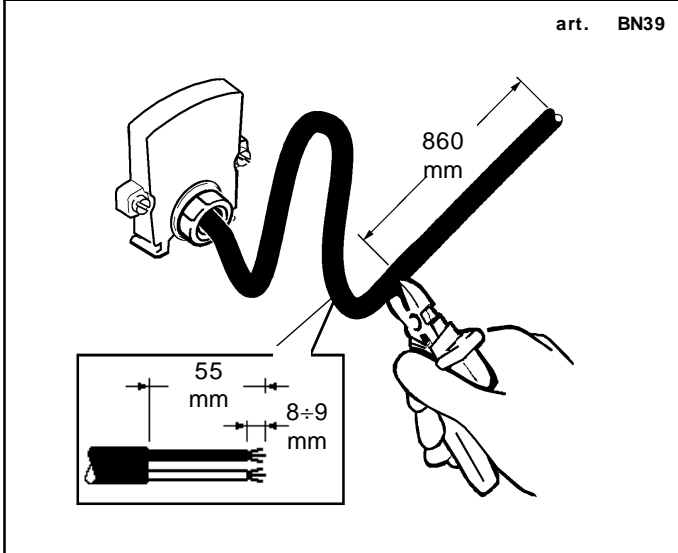
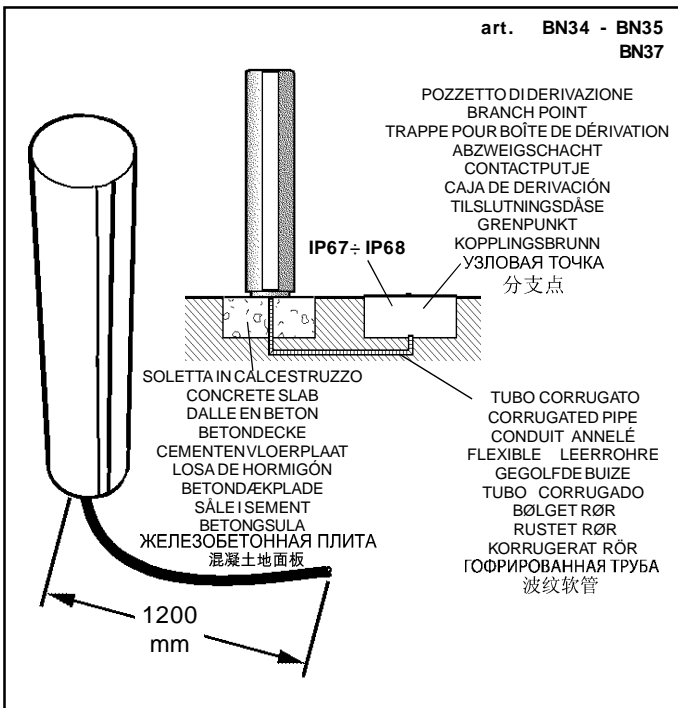
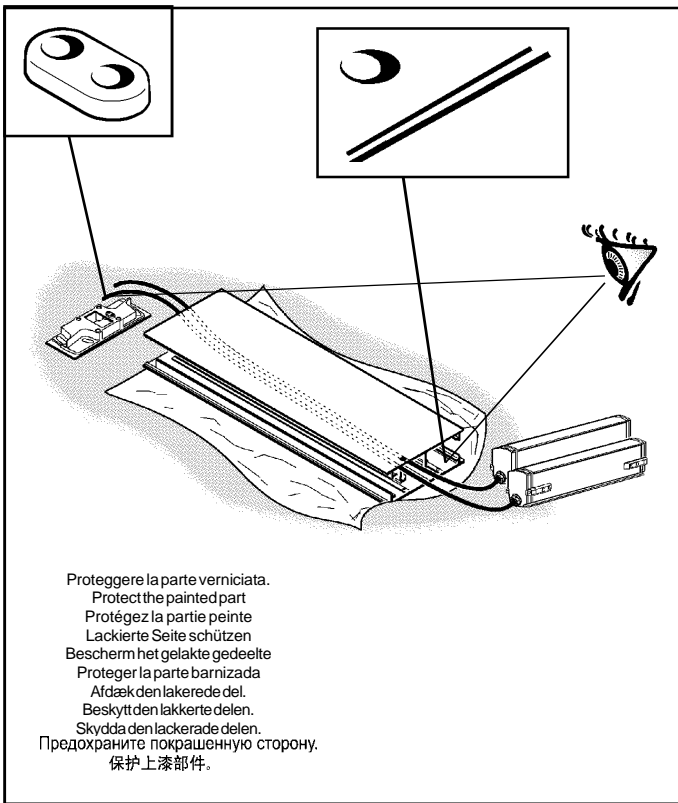

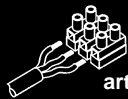

art. B512

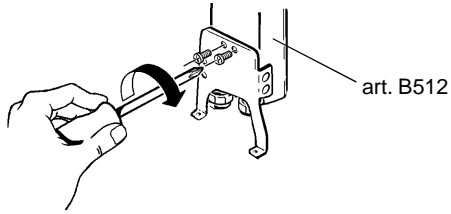

art. BN36
BN38

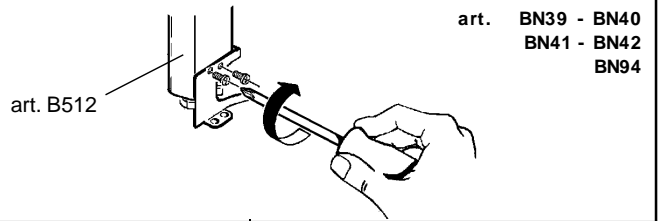

art. BN39 - BN40
BN41 - BN42
BN94

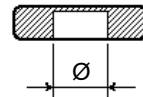
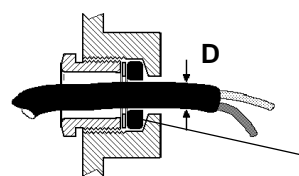
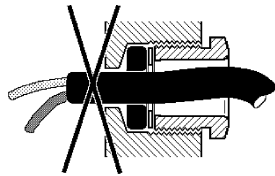
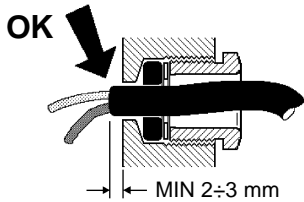

D (mm)	Ø (mm)
6,5 ÷ 9,0	8,0
9,0 ÷ 11,5	10,5

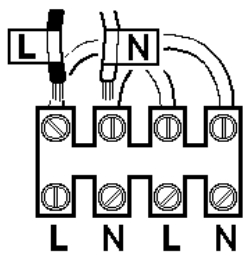
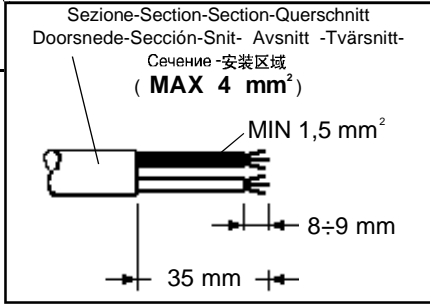
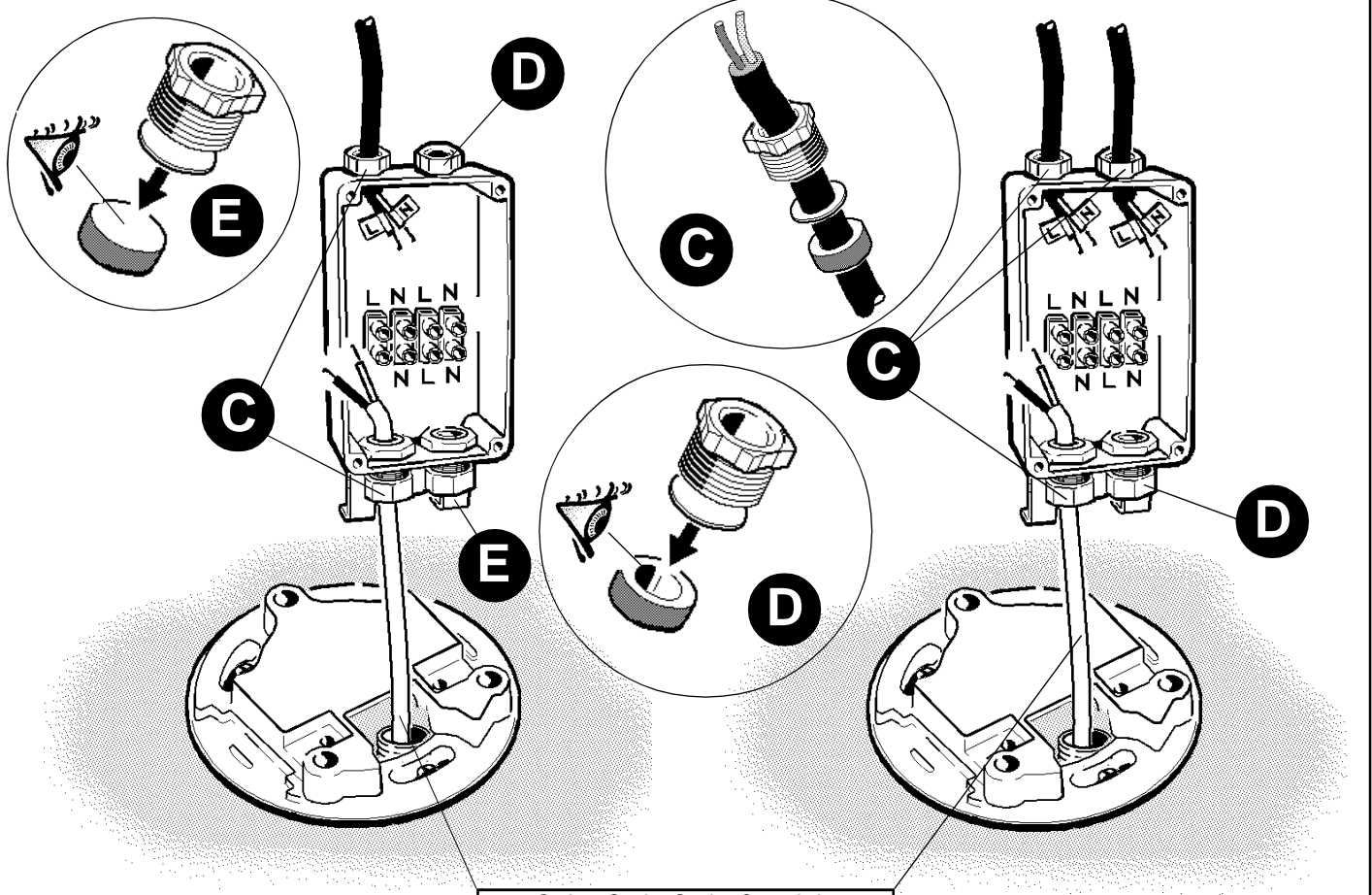

ALIMENTAZIONE
POWER SUPPLY
ALIMENTATION
EINSPEISUNG
STROOMVERZORGING
ALIMENTACION
STRØMFORSYNING
STRØMFORSYNING
ELFÖRSÖRJNING
ЭЛЕКТРОПИТАНИЕ
电源

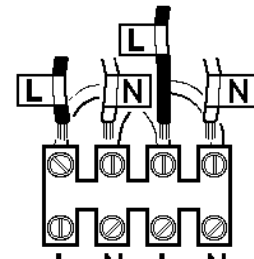

ALIMENTAZIONE
POWER SUPPLY
ALIMENTATION
EINSPEISUNG
STROOMVERZORGING
ALIMENTACION
STRØMFORSYNING
STRØMFORSYNING
ELFÖRSÖRJNING
ЭЛЕКТРОПИТАНИЕ
电源

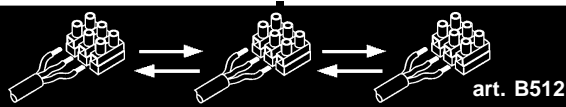

art. B512

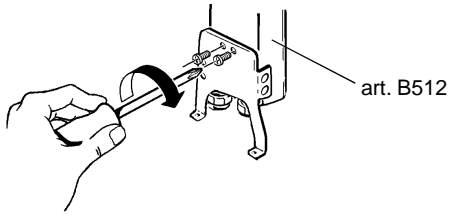

art. BN36
BN38

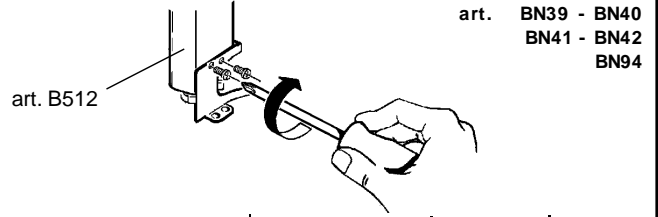

art. BN39 - BN40
BN41 - BN42
BN94

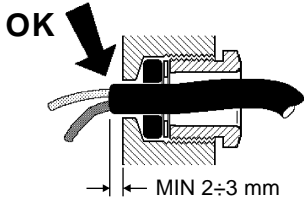

MIN 2÷3 mm

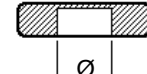
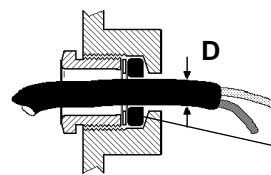
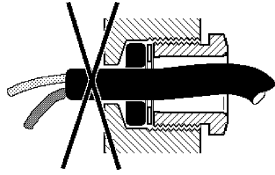

D (mm)	Ø (mm)
6,5 ÷ 9,0	8,0
9,0 ÷ 11,5	10,5

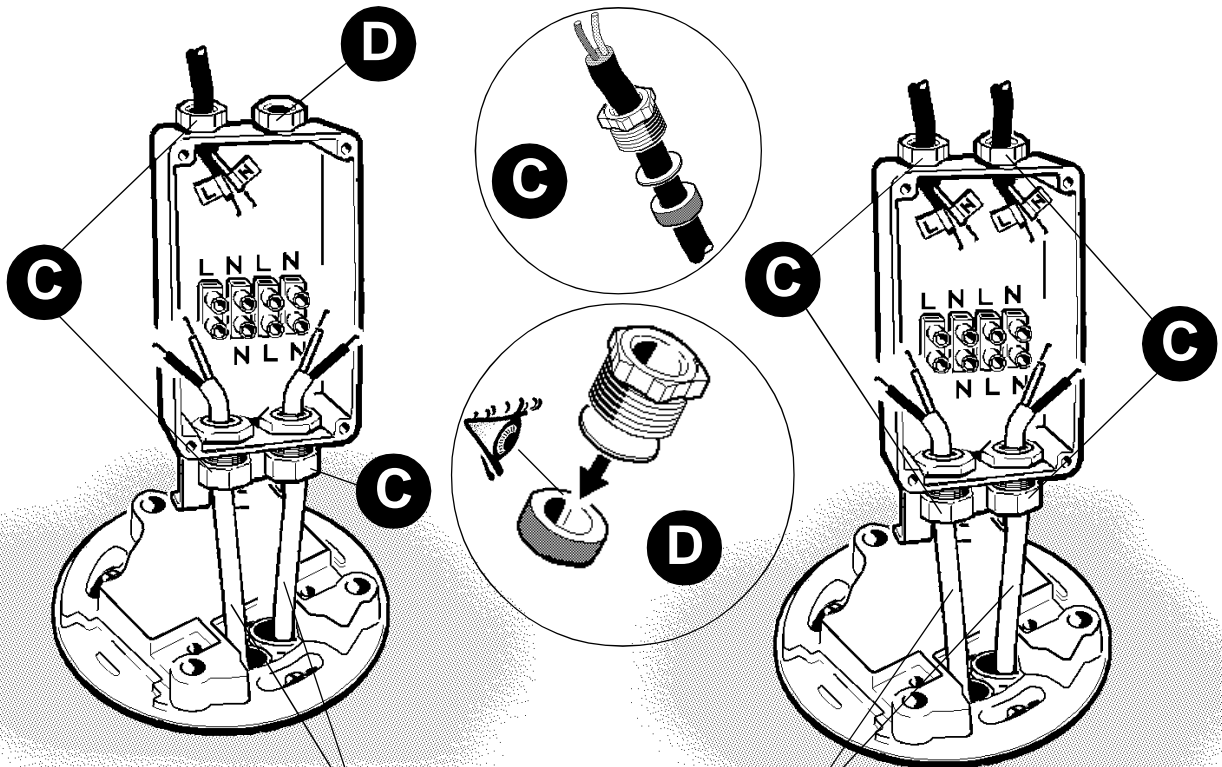

Sezione-Section-Section-Querschnitt
Doorsnede-Sección-Snit - Avsnitt - Tvärsnitt
Сечение-安装区域
(MAX 4 mm²)

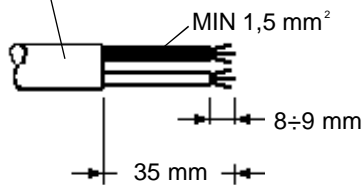

MAX 6A

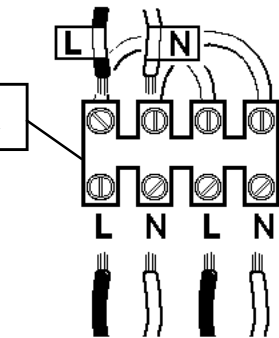

ALIMENTAZIONE
POWER SUPPLY
ALIMENTATION
EINSPEISUNG
STROOMVERZORGING
ALIMENTACION
STRØMFORSYNING
STRØMFORSYNING
ELFÖRSÖRJNING
ЭЛЕКТРОПИТАНИЕ
电源

CABLAGGIO PASSANTE
FEEDTHROUGH WIRING
CABLAGE TRAVERSANT
DURCHGANGSKABEL
KABELDOORGANG
CABLEADO PASANTE
GENNEMGÅENDE
LEDNINGER
FØRINGSKABLING
KABELGENOMFØRING
СКВОЗНОЙ МОНТАЖ
连接线架设

MAX 6A

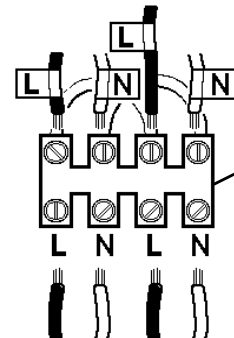

ALIMENTAZIONE
POWER SUPPLY
ALIMENTATION
EINSPEISUNG
STROOMVERZORGING
ALIMENTACION
STRØMFORSYNING
STRØMFORSYNING
ELFÖRSÖRJNING
ЭЛЕКТРОПИТАНИЕ
电源

CABLAGGIO PASSANTE
FEEDTHROUGH WIRING
CABLAGE TRAVERSANT
DURCHGANGSKABEL
KABELDOORGANG
CABLEADO PASANTE
GENNEMGÅENDE
LEDNINGER
FØRINGSKABLING
KABELGENOMFØRING
СКВОЗНОЙ МОНТАЖ
连接线架设

art. BN36 - BN38

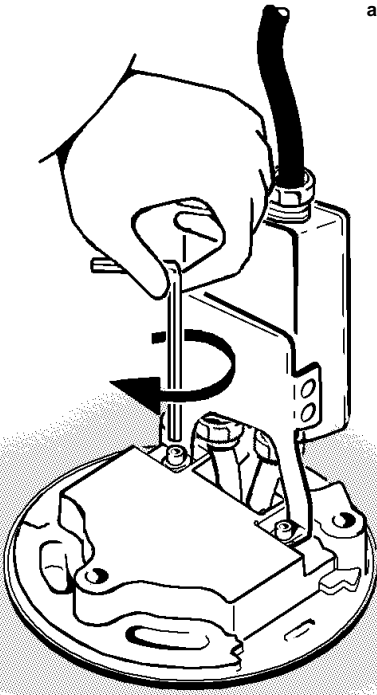

art. BN39 - BN40
BN41 - BN42
BN94

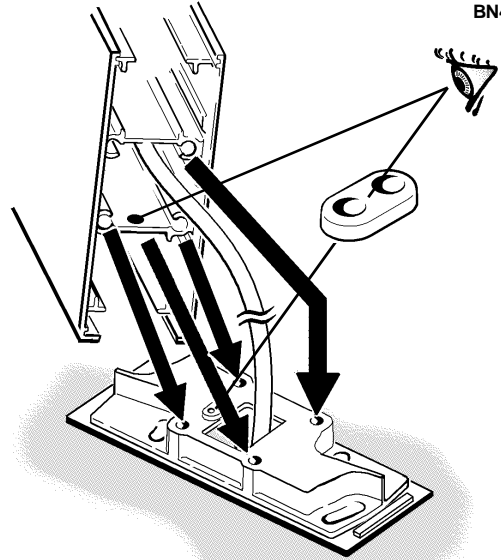

art. BN39 - BN40
BN41 - BN42
BN94

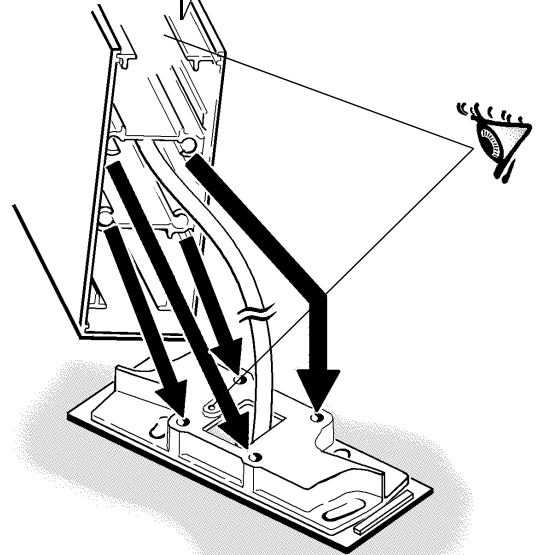
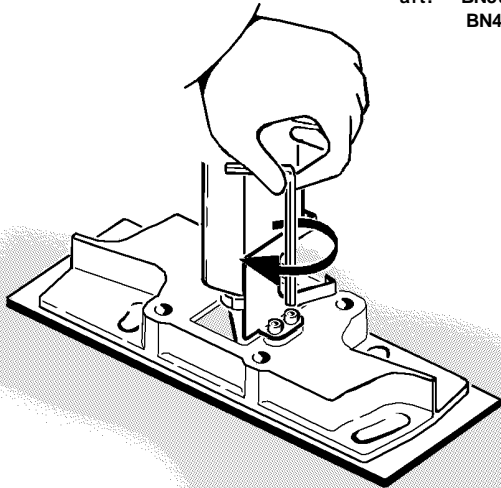

art. BN36 - BN38

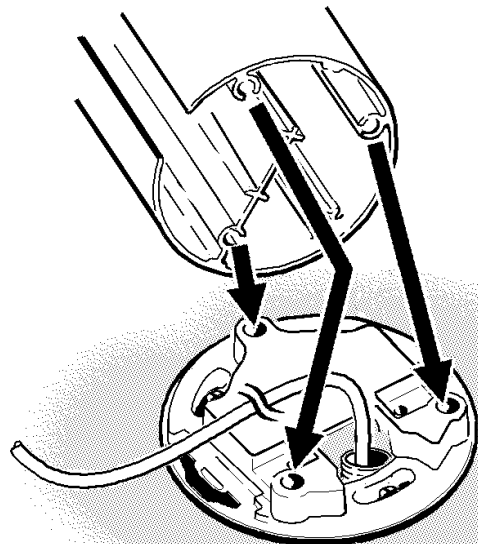
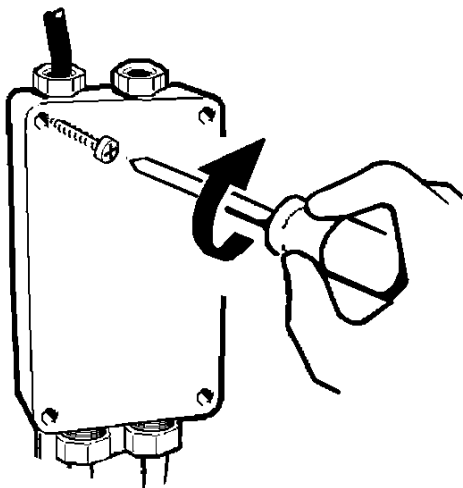

art. BN34 - BN35
BN37

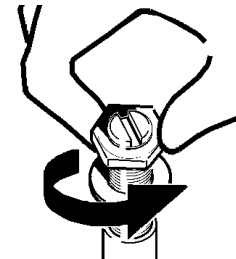
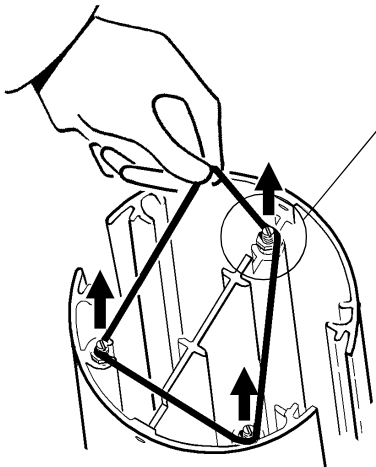
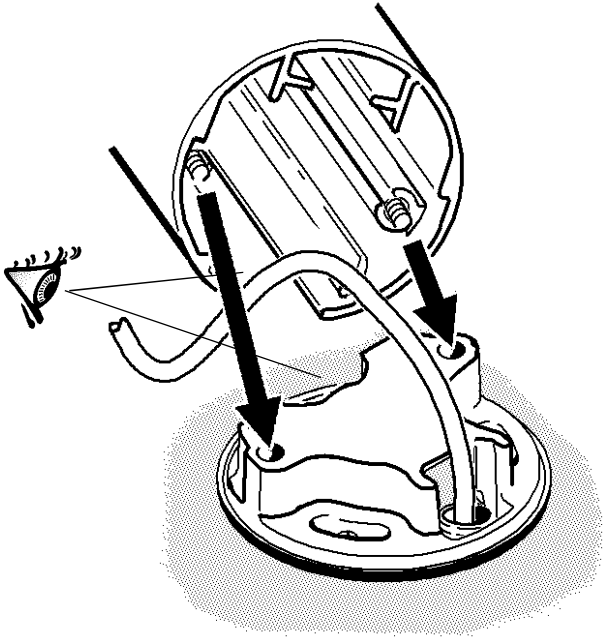

OK

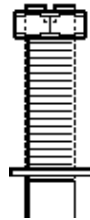

NO



- I Prima di utilizzare il prodotto asportare gli elastici.
GB Remove the elastic bands before using the product.
F Enlevez les élastiques avant d'utiliser le produit.
D Bevor Sie das Produkt verwenden, entfernen Sie die Gummis.
NL Voordat u het product gaat gebruiken moeten de elastieken verwijderd worden.
E Remover los elásticos antes de utilizar el producto.
DK Fjern elastikbåndene inden produktet tages i brug.
N Fjern de elastiske båndene før bruk av produktet.
S Ta bort gummisnoddarna innan utrustningen används.
RUS Перед началом эксплуатации прибора снимите с него резинки.
CN 在使用产品之前先取下弹性木梢。

Serrare a fondo
Tighten firmly
Serrer à fond
Fest einrasten
Goed aanschroeven
Enroscar en firme
Stram godt til
Skrues i bund
Dra åt till botten
Закрутить до упора
紧固

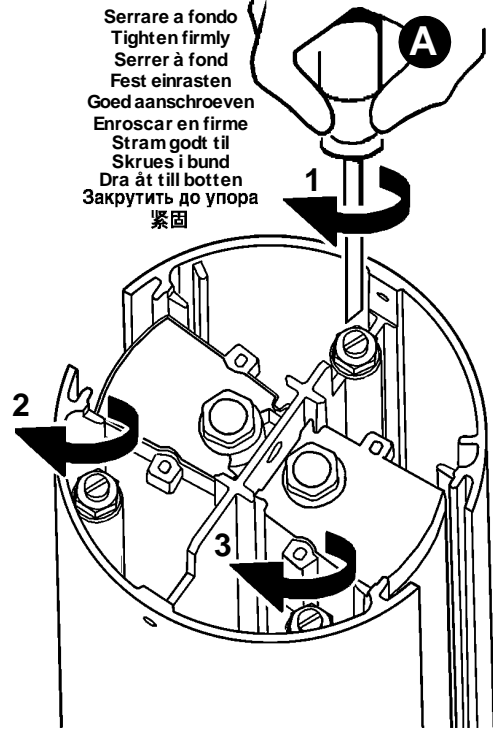

ART.

B
MAX
(Nm)

BN34 - BN35 - BN37	5
BN36 - BN38 - BN39 - BN40 BN41 - BN42 - BN94	10

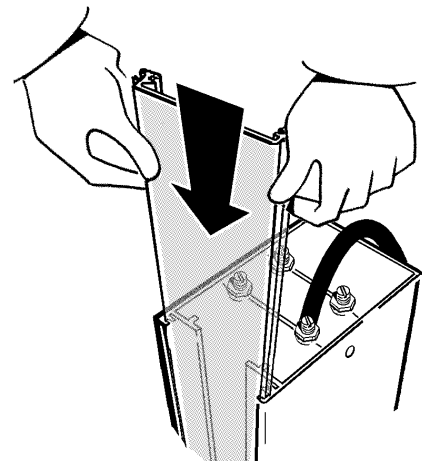
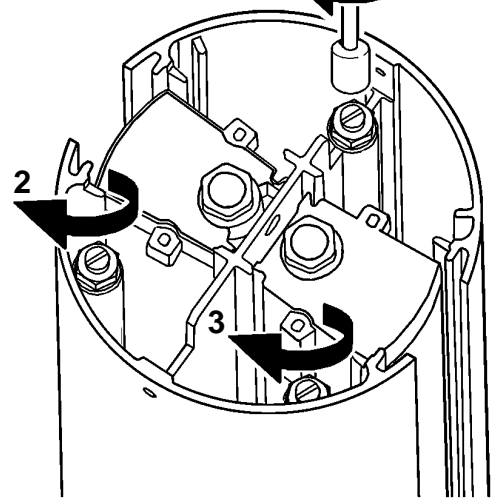
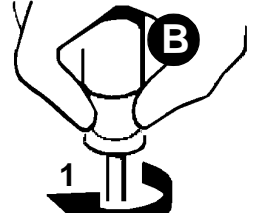

art. BN34 - BN35 - BN37

art. BN36 - BN38

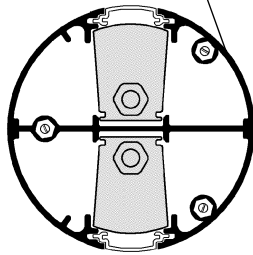
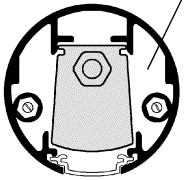

art. BN39 - BN40 - BN42

art. BN41 - BN94

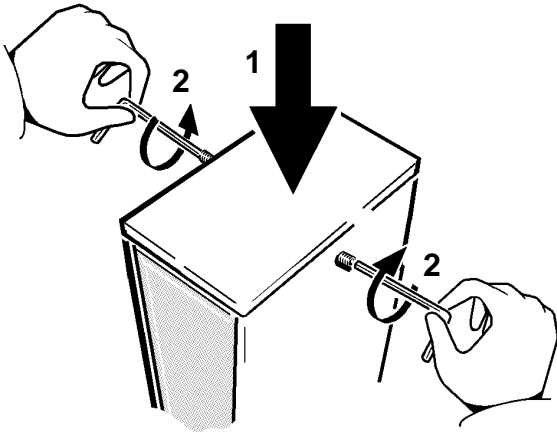
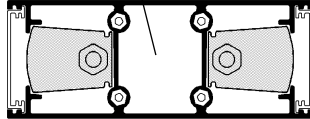
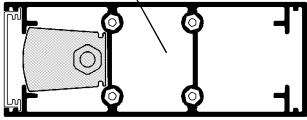

I Richiudendo il prodotto evitare di schiacciare i cavi elettrici.

GB When closing the product, do not compress the electrical cables.

F Lorsque vous refermez le produit, évitez d'écraser les câbles électriques.

D Achten Sie beim Schließen der Leuchte darauf, dass Sie keine elektrischen Kabel einklemmen.

NL Wanneer u het product afsluit moet u ervoor zorgen dat de elektrische kabels niet klem raken.

E Cuando cierre el producto, tenga cuidado de no aplastar los cables eléctricos.

DK Når produktet lukkes, skal man passe på ikke at klemme ledningerne.

N Når produktet lukkes, skal de elektriske kablene ikke trykkes sammen.

S Var försiktig så att inte elkablarna kläms när produkten stängs.

RUS При закрытии изделия следите, чтобы электрические провода не оказались зажатыми.

CN 关上产品的时候不要挤压电缆

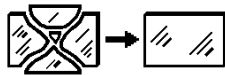

I In caso di rottura del vetro il prodotto non può essere utilizzato, contattare il costruttore per la sua sostituzione.

GB Should the glass break, the product cannot be used and you should contact the manufacturer for its replacement.

F En cas d'endommagement de l'écran de protection le produit ne peut pas être utilisé, contactez le fabricant pour le remplacement.

D Falls das Glas kaputt sein sollte, kann das Produkt nicht verwendet werden. Kontaktieren Sie in dem Fall den Hersteller, um das Glas zu ersetzen.

NL Als het glas gebroken is kan het apparaat niet worden gebruikt en moet u zich tot de fabrikant wenden voor het vervangen van het glas.

E No utilizar el producto en caso de ruptura del vidrio y contactar el fabricante para la sustitución.

DK Hvis produktets glas ødelægges, kan det ikke anvendes. Kontakt forhandleren med henblik på udskiftning.

N Hvis glasset skulle knuses, kan ikke produktet brukes, og du må ta kontakt med produsenten for å få det skiftet.

S Om glaslet går sönder kan inte produkten användas. Kontakta tillverkaren för att byta ut glaslet.

RUS В случае разбивания стекла не используйте прибор, обратитесь к его производителю для замены.

CN 一旦玻璃破碎后产品将不能再使用, 须联系生产商予以更换。

I N.B.: Per la sostituzione del LED contattare l'azienda iGuzzini.

GB N.B.: For information on LED replacement please contact iGuzzini.

F N.B.: Pour procéder au remplacement de la LED, adressez-vous à la société iGuzzini.

D N.B.: Bezüglich des Austausches der LED kontaktieren Sie bitte die Firma iGuzzini.

NL N.B.: Voor het vervangen van de LED neemt u contact op met het bedrijf iGuzzini.

E NOTA: Para sustituir el LED llame a la empresa iGuzzini.

DK N.B.: For udskiftning af lysdioden, skal man kontakte iGuzzini.

N N.B.: For informasjon om skifte av LED, vennligst ta kontakt med iGuzzini.

S OBS! För byte av lysdioden, kontakta företaget iGuzzini.

RUS ПРИМЕЧАНИЕ: Для замены СИДов обращайтесь в компанию iGuzzini.

CN 注意: 如需LED更换的信息, 请联系iGuzzini.

+ ART. X025 - X026 - X027 - X028 - X029 - X030 X031 - X032 - X033 - X034 - X035 - X036

Accessorio - Accessory - Accessoire - Zubehörteil - Accessoire
Accesorio - Tilbehør - Tilbehør - Tillbehör - Аксессуары - 附件

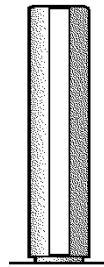

ART.

BN34



art.

X025

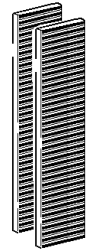

art.

X031

BN35

BN36

BN37

BN38

BN39

BN40

BN41

BN42

BN94

X026

X027

X028

X029

X030

X031

X032

X033

X034

X035

X036

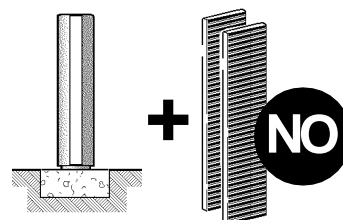
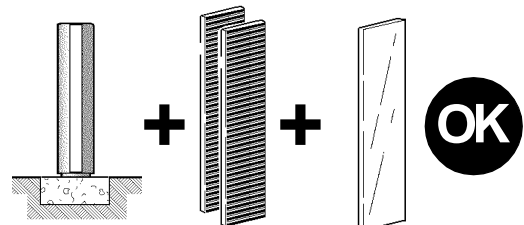

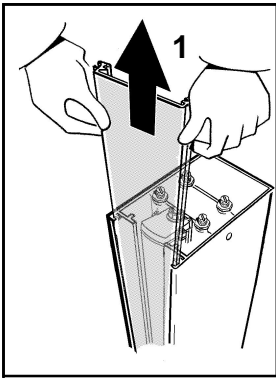

art. X028 - X029
X030

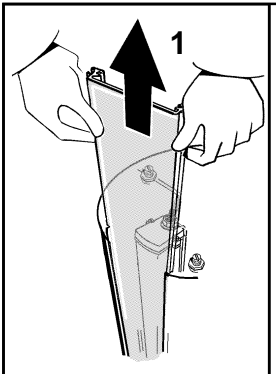
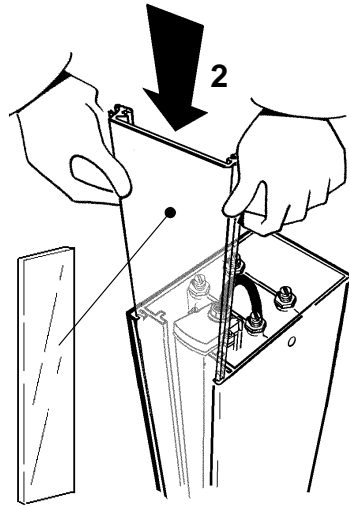

art. X025 - X026 - X027

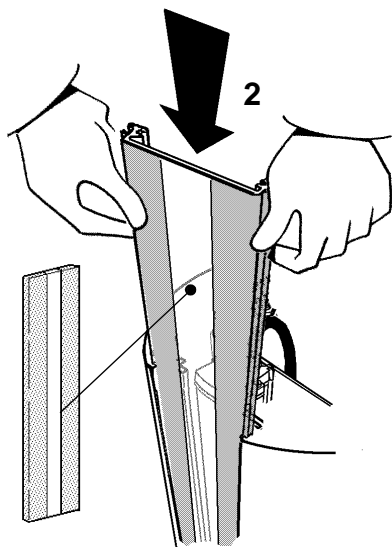

art. X028 - X029 - X030
X031 - X032 - X033

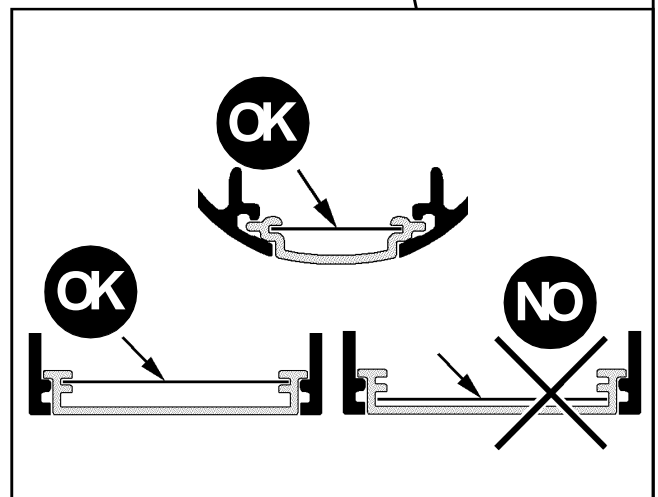
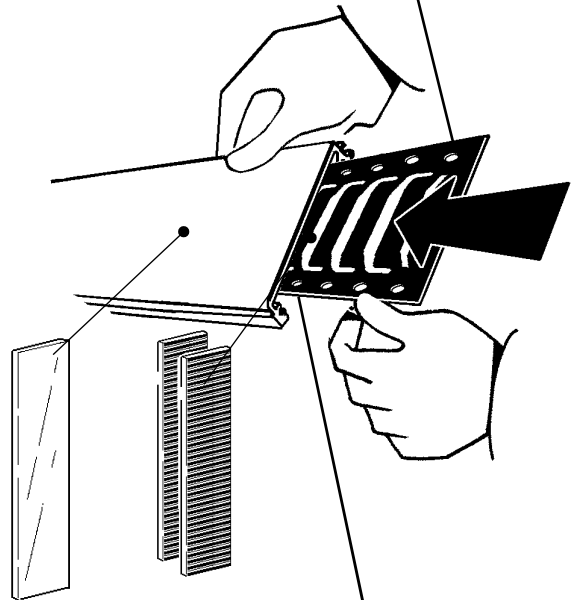
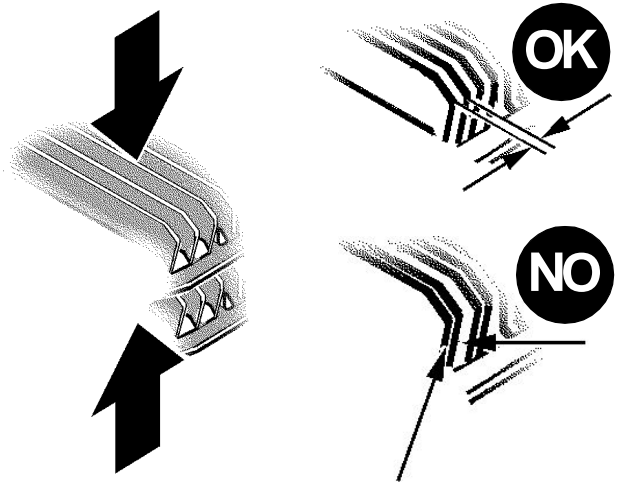

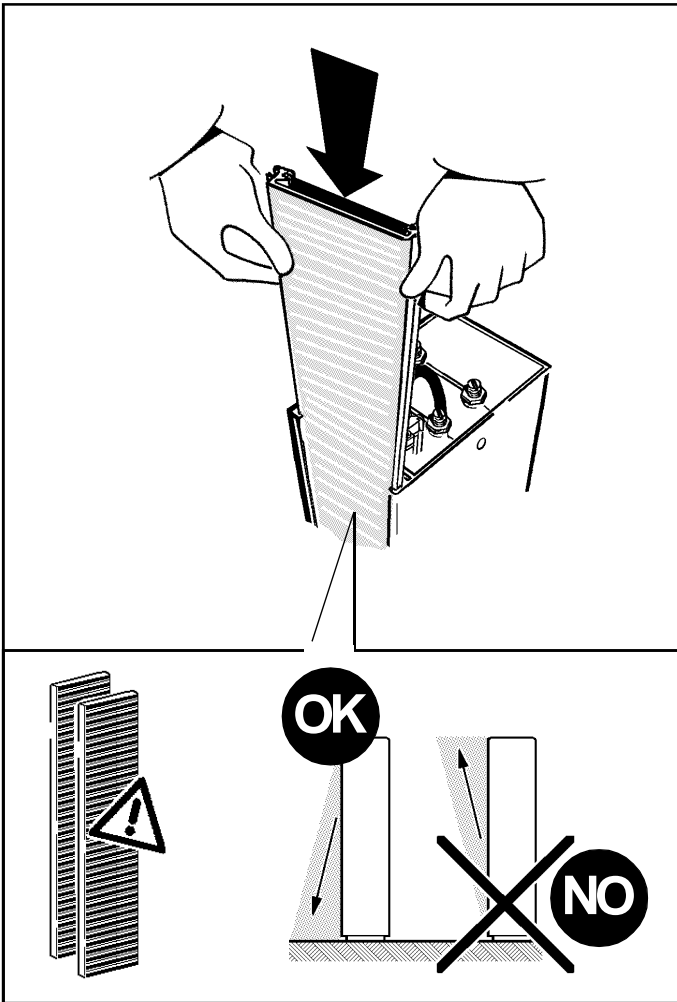

PENCIL LED

تحذير:

لا يمكن ضمان سلامة هذا الجهاز إلا إذا التزمت بهذه التعليمات. يجب حفظها في مكان آمن.

ATTENZIONE:

LA SICUREZZA DELL'APPARECCHIO E' GARANTITA SOLO CON L'USO APPROPRIATO DELLE SEGUENTI ISTRUZIONI; PERTANTO E' NECESSARIO CONSERVARLE.

WARNING:

THE SAFETY OF THIS FIXTURE IS GUARANTEED ONLY IF YOU COMPLY WITH THESE INSTRUCTIONS; REMEMBER TO CONSERVE IN A SAFE PLACE.

ATENCIÓN:

LA SEGURIDAD DEL APARATO SE GARANTIZA SOLO CUMPLIENDO CUIDADOSAMENTE LAS SIGUIENTES INSTRUCCIONES; POR ELLO, ES NECESARIO CONSERVARLAS.

ملاحظة: ملاحظة: أثناء تركيب نظام PENCIL. يجب التقيد بحرص بالنظم السائدة المتعلقة بالشبكة الكهربائية.

N.B.: DURANTE L'INSTALLAZIONE DEL SISTEMA "PENCIL" RISPETTARE SCRUPOLOSAMENTE LE NORME IMPIANTISTICHE VIGENTI.

N.B.: WHEN INSTALLING THE SYSTEM "PENCIL", STRICTLY COMPLY WITH ALL REGULATIONS ON INSTALLATION IN FORCE.

N.B.: DURANTE LA INSTALACIÓN DEL SISTEMA "PENCIL" RESPETAR ESCRUPULOSAMENTE LAS NORMAS DE INSTALACIÓN VIGENTES.

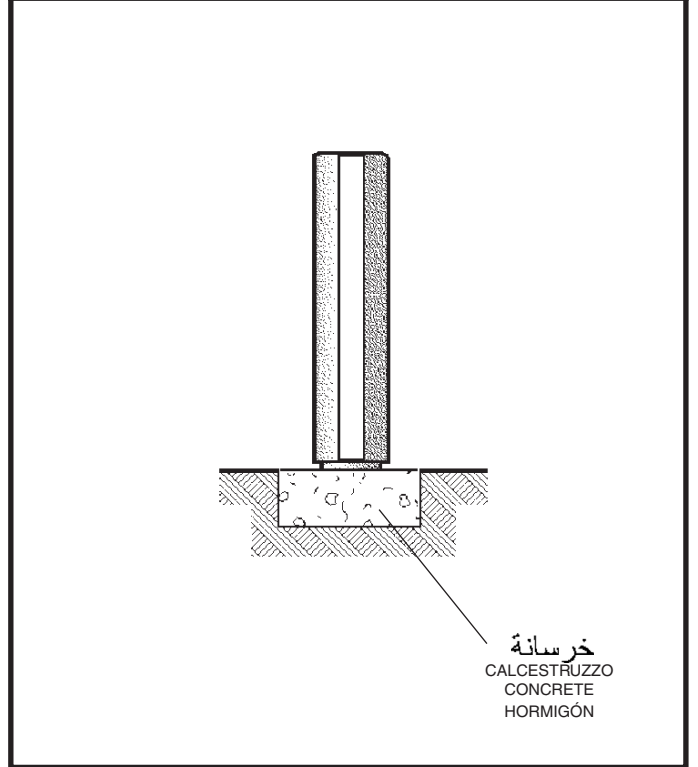
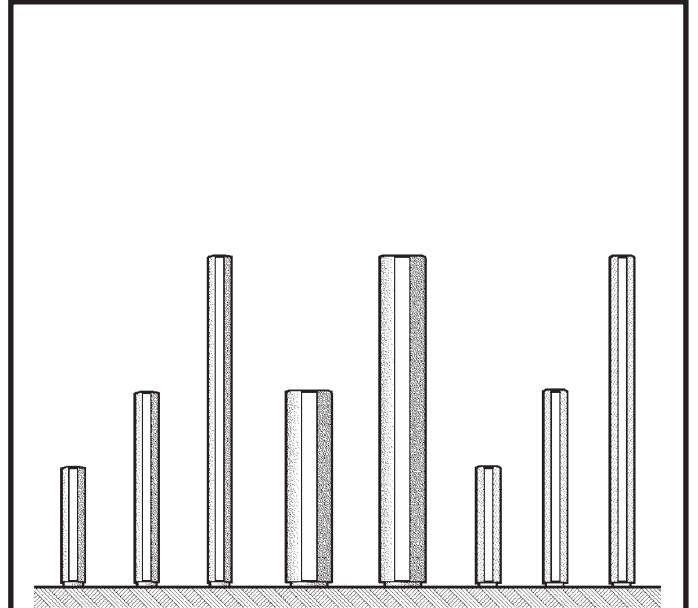
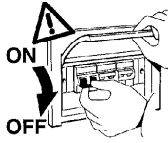

ملاحظة: عند تركيب الجهاز يجب مراعاة عدم دفن القاعدة أو وضعها في الأماكن المعرضة عن تعرض بالمياه.

I N.B.: Installando l'apparecchio, evitare che la base venga interrata o posizionata in punti soggetti al ristagno dell'acqua.

GB N.B.: Whilst installing the appliance, avoid concealing its base or placing it in areas which are susceptible to damp.

E NOTA: Al instalar el aparato, evite que la base se entierre o se coloque en puntos donde se pueda estancar el agua.



جانب المشاة أو الدراجات الهوائية
LATO PEDONALE O CARRABILE
PEDESTRIAN OR VEHICULAR SIDE
LADO PEATONAL O VEHICULAR

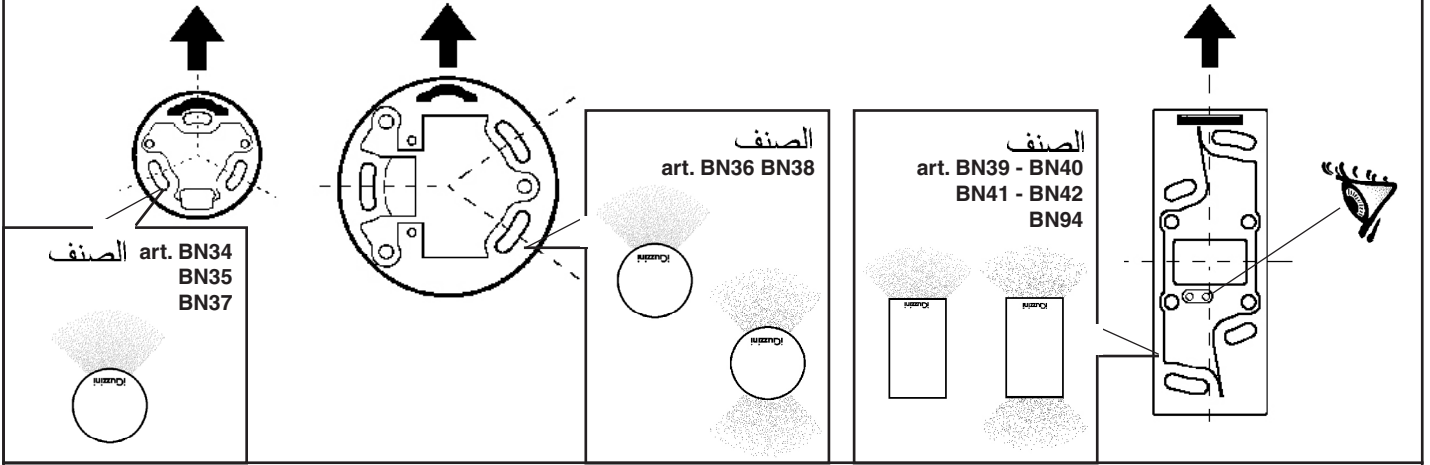

عند التثبيت ينصح باستخدام مسامير كبيرة نوع FZA- I- M 6 ÷ 8 أو ما شابهها ومن صنع شركات أخرى.

PER IL FISSAGGIO SI CONSIGLIA DI UTILIZZARE TASSELLI PER ANCORAGGI PESANTI TIPO FZA- I- M 6 ÷ 8 FISCHER, O SIMILARI ANCHE DI ALTRI COSTRUTTORI.

FOR FIXING USE HEAVY DUTY PLUGS, SUCH AS FZA- I- M 6 ÷ 8 FISCHER OR SIMILAR, INCLUDING FROM OTHER MANUFACTURERS.

PARA LA FIJACIÓN SE RECOMIENDA UTILIZAR TACOS PARA ANCLAJES DE GRAN RESISTENCIA, TIPO FZA-I-M 6 ÷ 8 FISCHER, O SIMILARES, INCLUSO DE OTROS FABRICANTES.

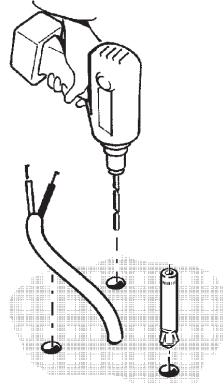
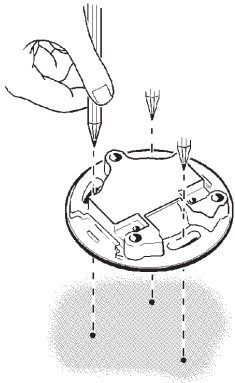

الصنف ART.	ملم V (mm)
BN34 - BN35 - BN37	M 6
V - BN38 - BN39 - BN40 BN41 - BN42 - BN94	M 8

أنبوب تصريف
TUBO PER DRENAGGIO
DRAINAGE PIPE
TUBO PARA DRENAJE

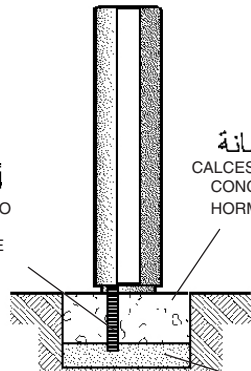

خرسانة
CALCESTRUZZO
CONCRETE
HORMIGÓN

حصى للتصريف
GHIAIA PER DRENAGGIO
GRAVEL LAYER FOR DRENAJE
GRAVILLA PARA DRENAJE

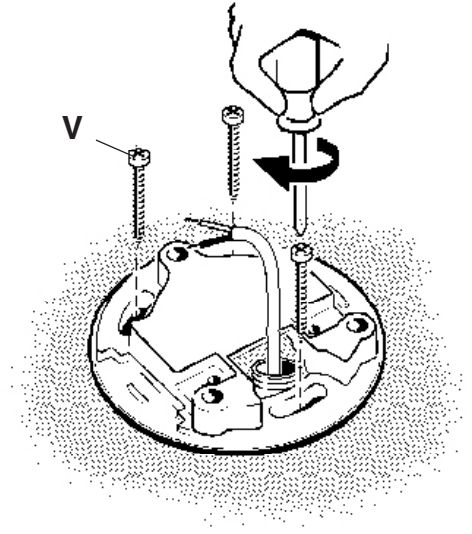



art. B515 - B516 - B517

جانب المشاة أو الدراجات الهوائية
LATO PEDONALE O CARRABILE
PEDESTRIAN OR VEHICULAR SIDE
LADO PEATONAL O VEHICULAR

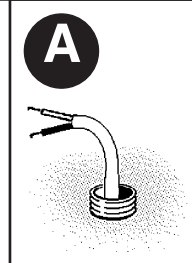
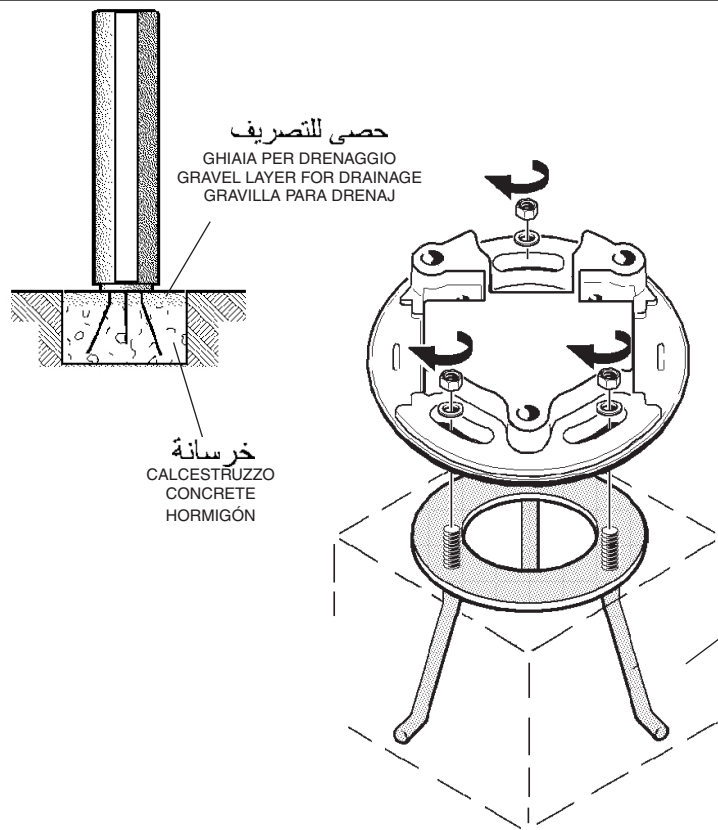
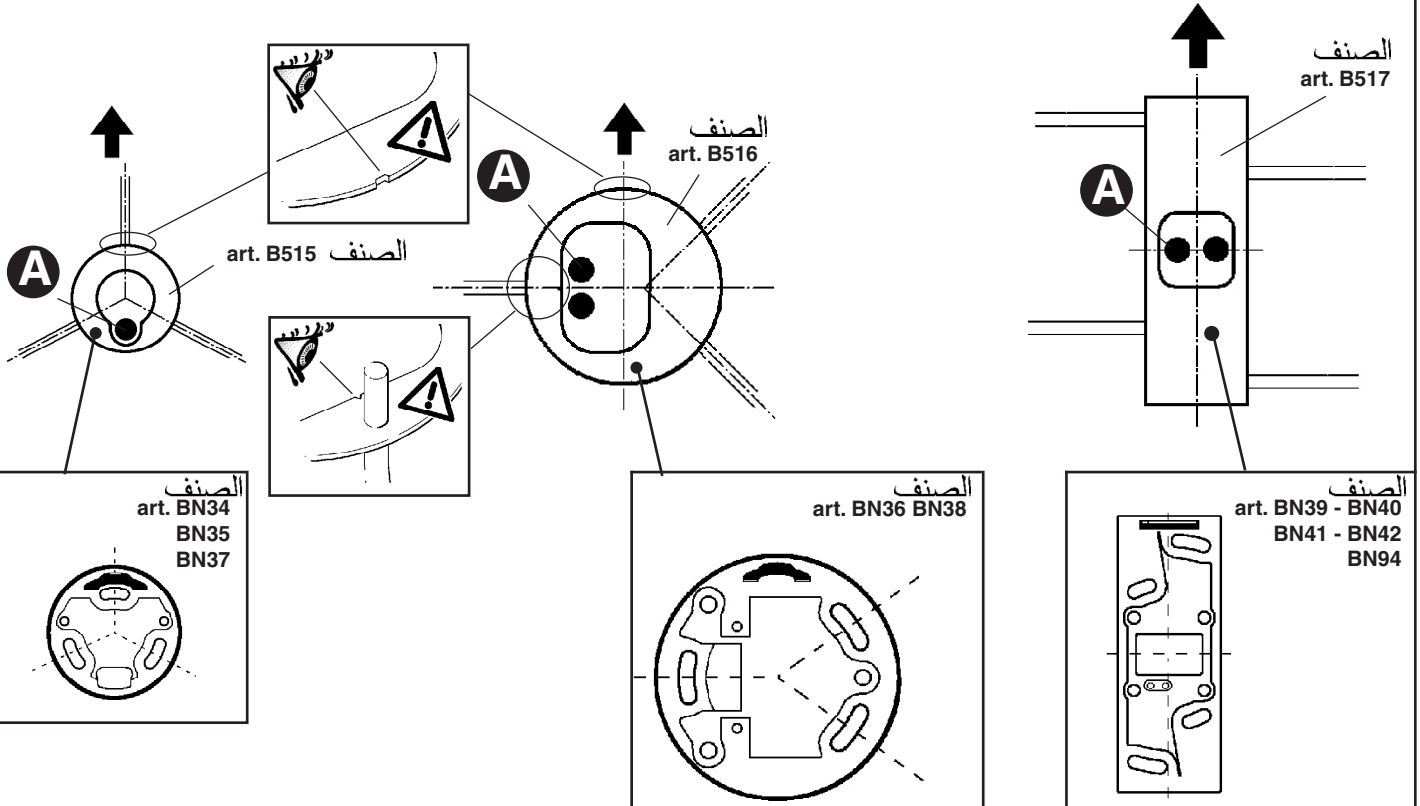

الصف ART.	الصف art.	مم B min (mm)
BN34 - BN35 - BN37	B515	-
BN36 - BN38	B516	254
BN39 - BN40 - BN41 - BN42 BN94	B517	190 254

الصف
art. B515
B516
B517

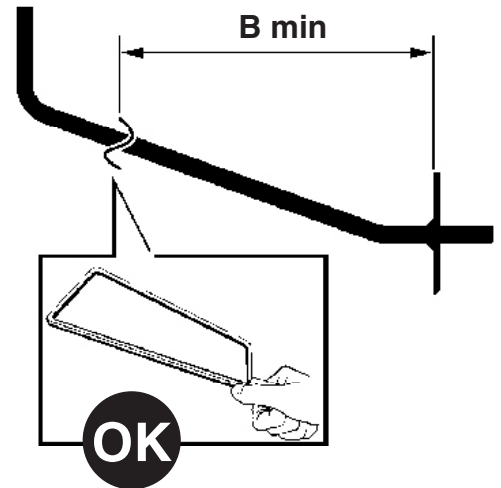

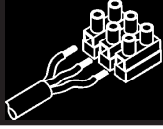

في حال تلف الكبل الخارجي المرص، يجب تغييره من قبل المصنع أو من قبل مركز الخدمة المخوّل أو من قبل أحد أعضاء الطاقم المتدربين والمؤهلين وذلك لتحاكي إلحاق أي خطر.

I In caso di danneggiamento del cavo flessibile esterno, questo deve essere sostituito dal costruttore, o dal suo servizio di assistenza, o da personale qualificato equivalente, al fine di evitare pericoli.

GB Should the outer flexible cable be somehow damage, the latter should be replaced by the manufacturer, or by the corresponding service centre, or by an appropriate and qualified member of staff in order to avoid all risk of danger.

E En caso de daños el cable flexible externo debe substituirse por el fabricante, su servicio de asistencia o personal calificado equivalente para evitar peligros.

استعمل كبلًا يعازل مزدوج للتمديدات الكهربائية.

I Per il cablaggio elettrico utilizzare cavi con doppio isolamento.

GB Use cable with double insulation for the electric wiring.

E Para el cableado eléctrico servirse de cables con doble aislamiento.

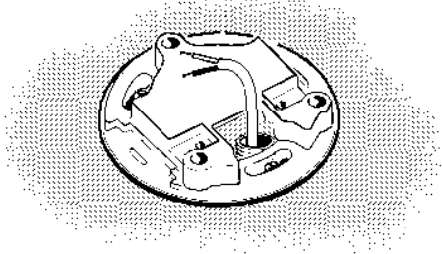

التسليك من خلال
CABLAGGIO PASSANTE
FEEDTHROUGH WIRING
CABLEADO PASANTE

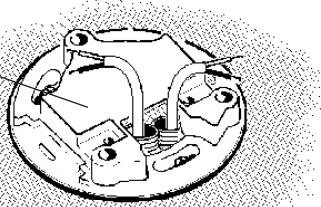

ملاحظة: عند التوصل بالشبكة الكهربائية يجب استخدام تصنيف B511 - B512 أو للتيار
توصيل من الفئة II التي تضمن حماية من الدرجة IP66 .

I N.B.: Per il collegamento elettrico alla rete , servirsi dell'art. B511 - B512 o di altri dispositivi di connessione in classe II che garantiscano il grado di protezione IP66.

GB N.B.: To connect to the mains, use art. B511 - B512 or other class II connection devices which guarantee an IP66 degree of protection.

E NOTA: Para conexión eléctrica a la red, utilizar e art. B511 - B512 u otros dispositivos de conexión en clase II, para garantizar grado de protección IP66 .

الصنف
art. BN34
BN35
BN37

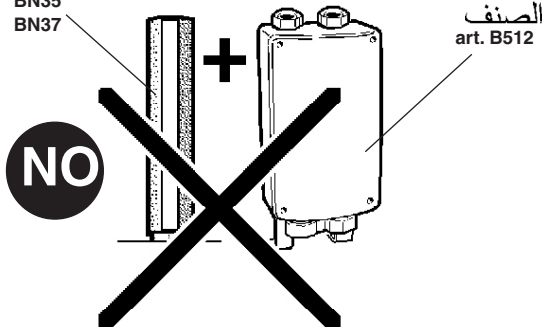

الصنف
art. B512

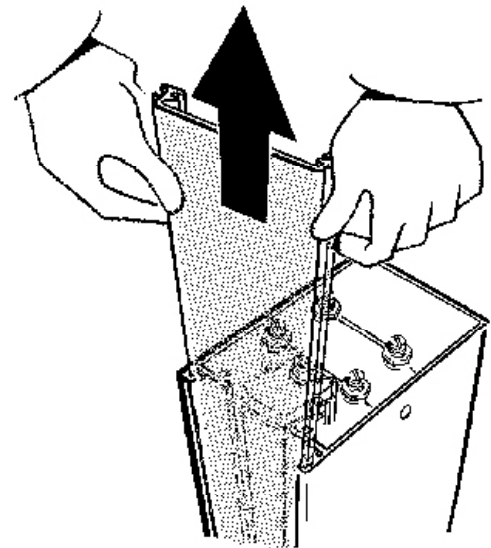
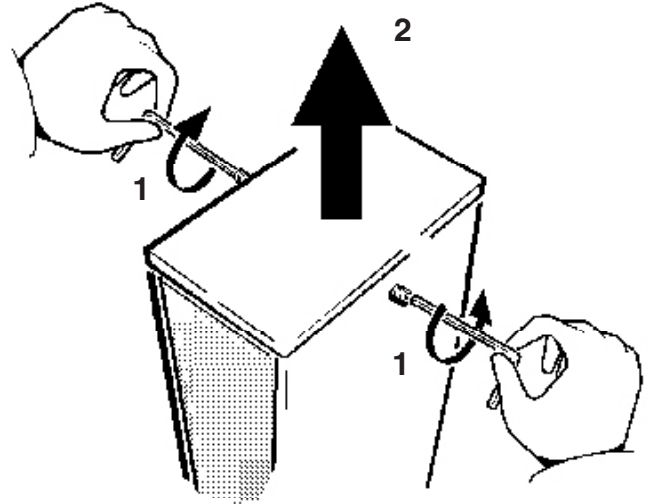

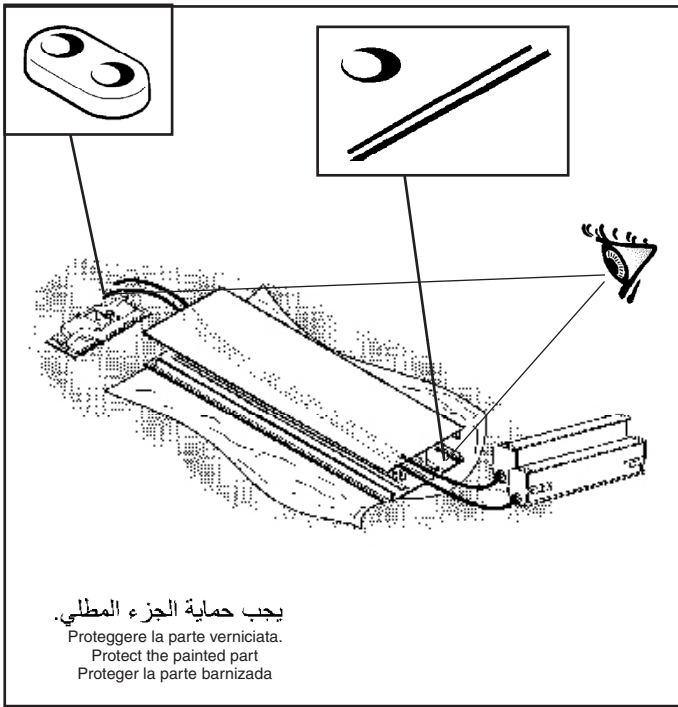

الصفحة
 art. BN34 - BN35
 BN37

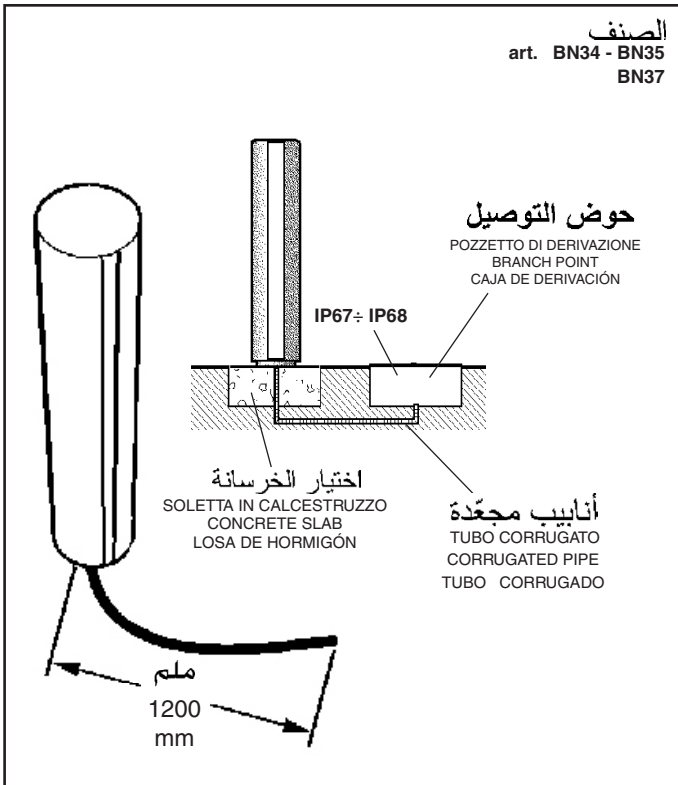

الصفحة
 art. BN39

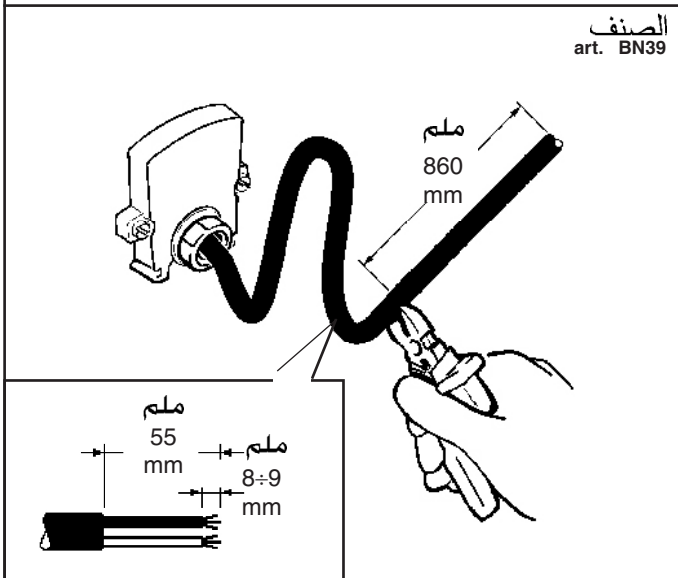



art. B512 **الصنف**

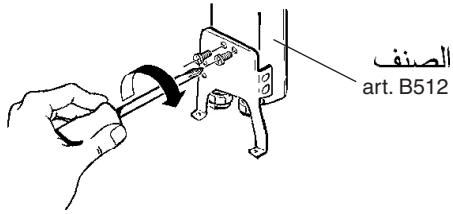

الصنف
art. BN36
BN38

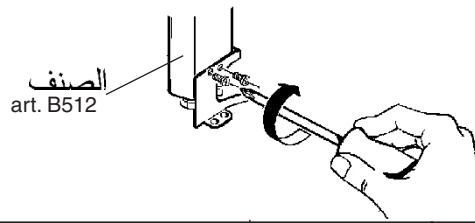

الصنف
art. BN39 - BN40
BN41 - BN42
BN94

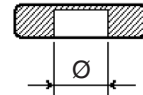
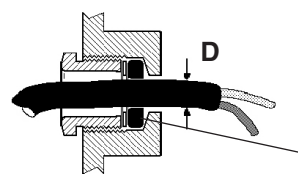
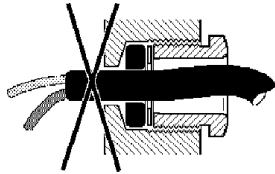
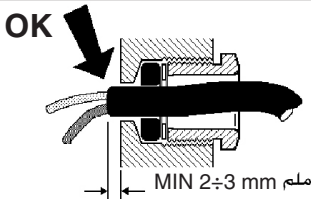

ملم D (mm)	ملم Ø (mm)
6,5 ÷ 9,0	8,0
9,0 ÷ 11,5	10,5

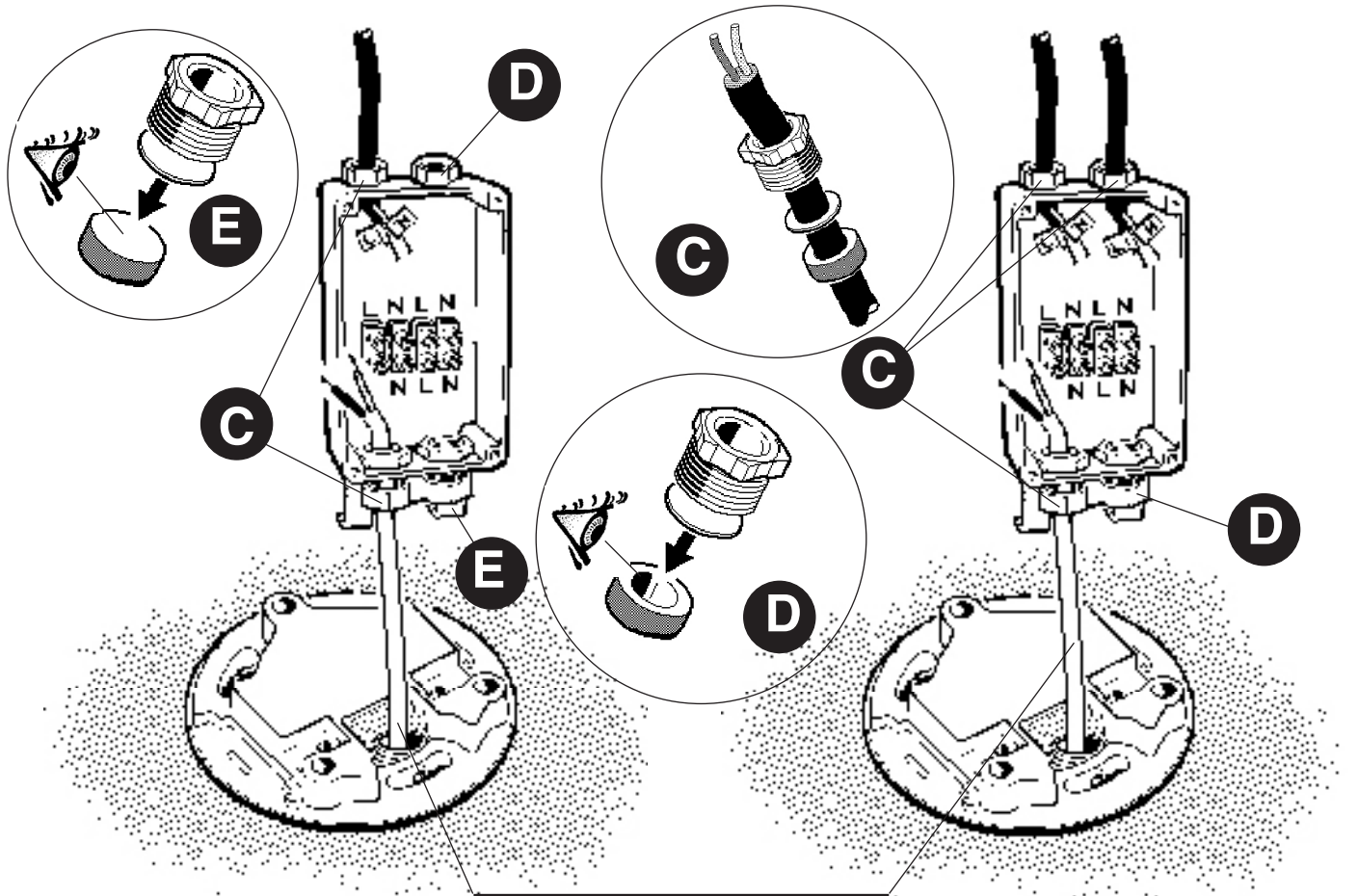

المقطع - Sezione
Section - Sección

ملم² (MAX 4 mm²)

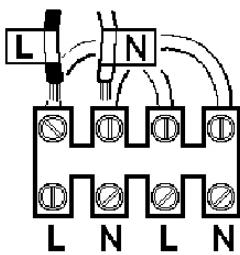
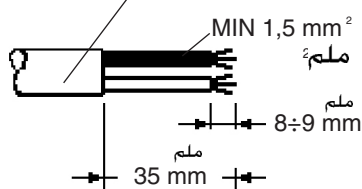

مصدر التيار
ALIMENTAZIONE
POWER SUPPLY
CEBADOR

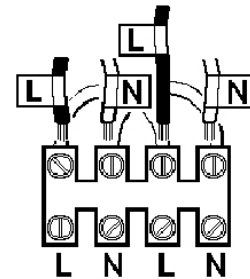

مصدر التيار
ALIMENTAZIONE
POWER SUPPLY
CEBADOR



art. B512

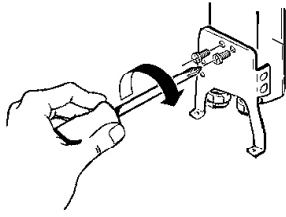

الصنف
art. B512

الصنف
art. BN36
BN38

الصنف
art. B512

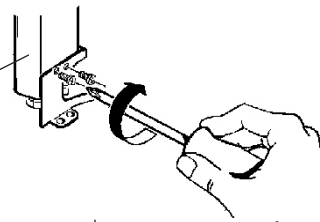

الصنف
art. BN39 - BN40
BN41 - BN42
BN94

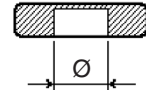
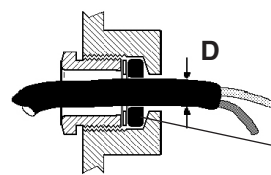
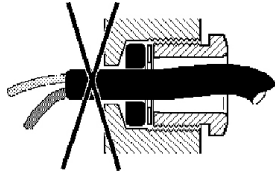
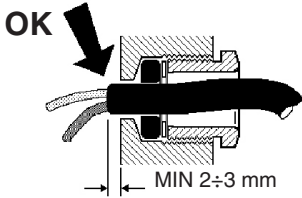

ملم D (mm)	ملم Ø (mm)
6,5 ÷ 9,0	8,0
9,0 ÷ 11,5	10,5

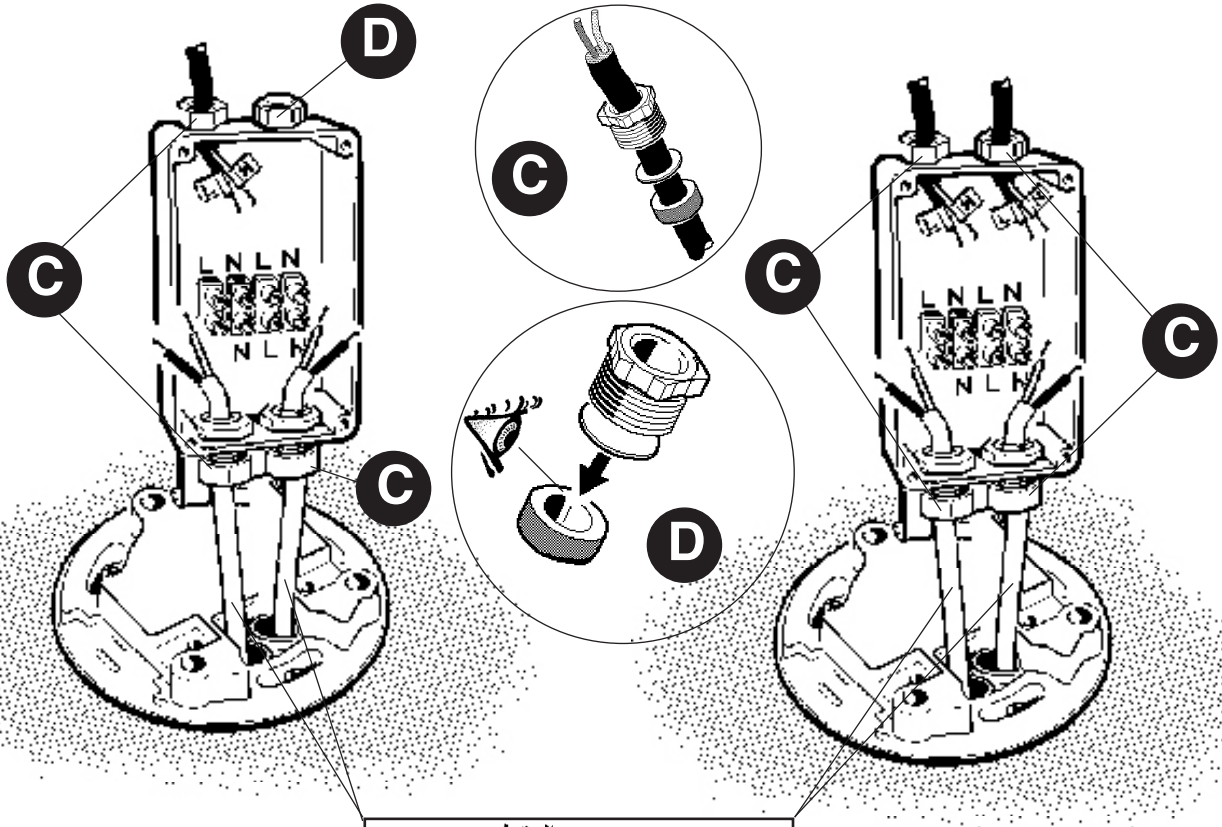

المقطع - Sezione
Section - Sección

ملم² (MAX 4 mm)²

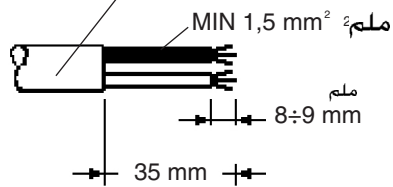

MAX 6A

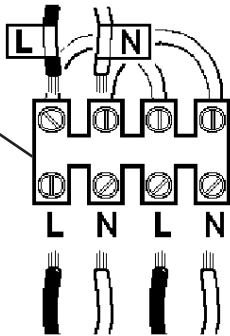

مصدر التيار
ALIMENTAZIONE
POWER SUPPLY
CEBADOR

التسليك من خلال
CABLAGGIO PASSANTE
FEEDTHROUGH WIRING
CABLEADO PASANTE

MAX 6A

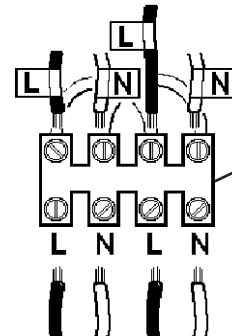

مصدر التيار
ALIMENTAZIONE
POWER SUPPLY
CEBADOR

التسليك من خلال
CABLAGGIO PASSANTE
FEEDTHROUGH WIRING
CABLEADO PASANTE

الصنف
art. BN36 - BN38

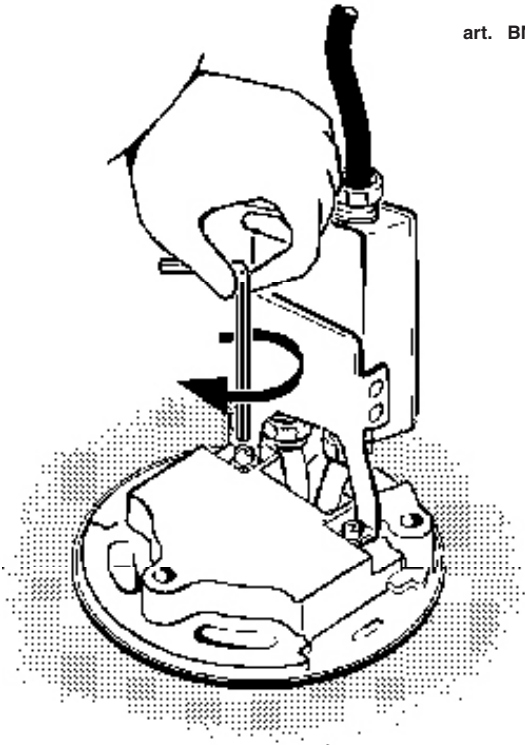

الصنف
art. BN39 - BN40
BN41 - BN42
BN94

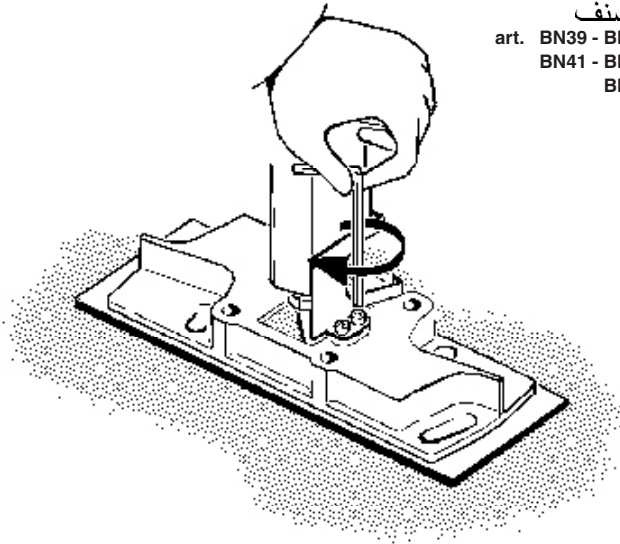

الصنف
art. BN39 - BN40
BN41 - BN42
BN94

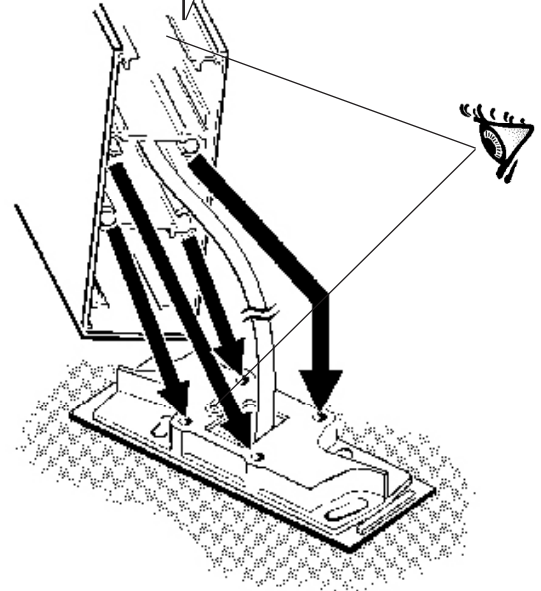
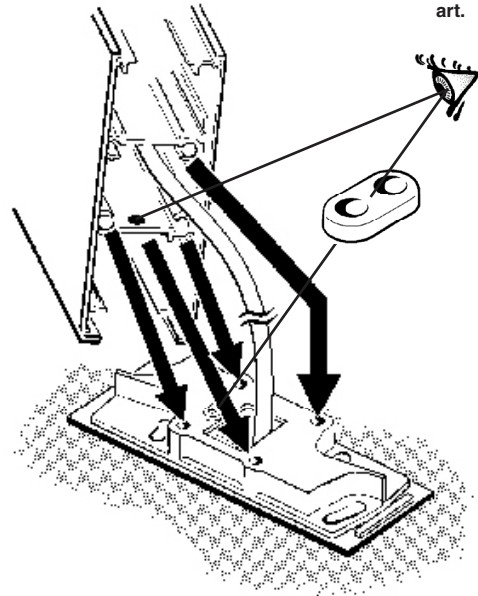

الصنف
art. BN36 - BN38

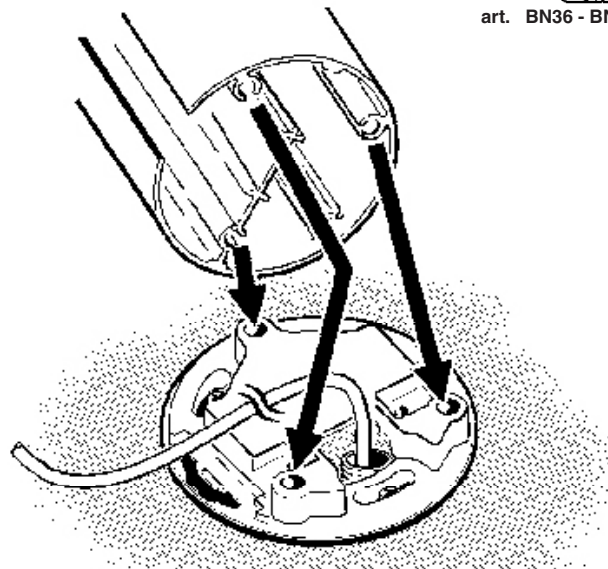
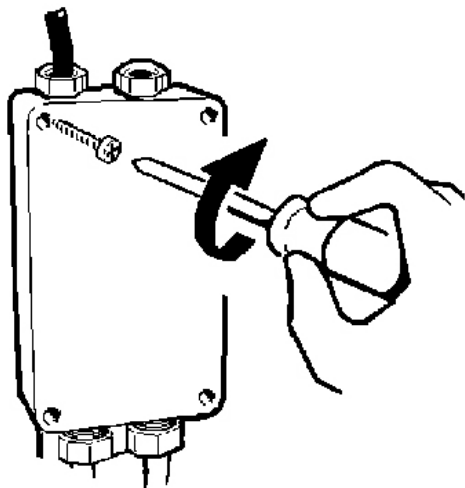

الصف
art. BN34 - BN35
BN37

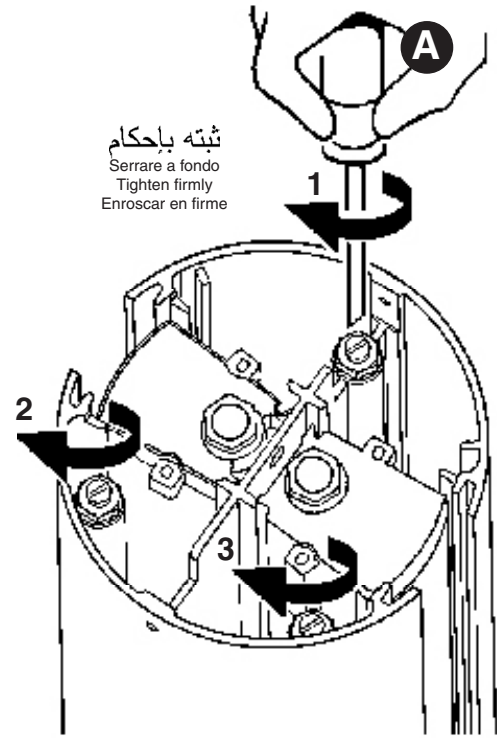
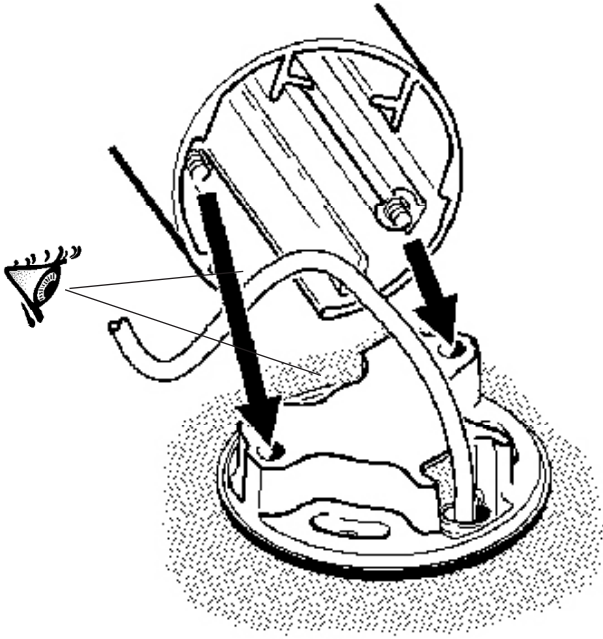

الصف
ART.

B
MAX
(Nm)

BN34 - BN35 - BN37

5

BN36 - BN38 - BN39 - BN40
BN41 - BN42 - BN94

10

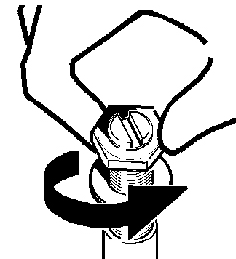
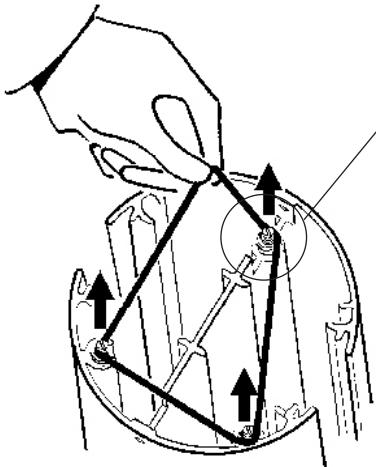
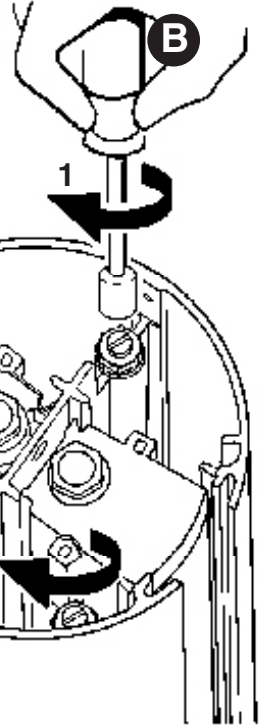

OK

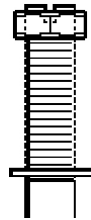

NO



عز الأشرطة المطاطية قبل استخدام المنتج.

I Prima di utilizzare il prodotto asportare gli elastici.

GB Remove the elastic bands before using the product.

E Remover los elásticos antes de utilizar el producto.

+ ART. X025 - X026 - X027 - X028 - X029 - X030
X031 - X032 - X033 - X034 - X035 - X036

ملحق

ACCESSORIO - ACCESSORY - ACCESORIO

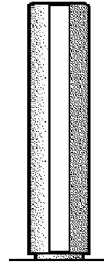

الصنف
ART.



الصنف
art.

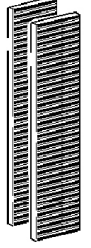

الصنف
art.

BN34	X025	X031
BN35	X026	X032
BN36		
BN37	X027	X033
BN38		
BN39	X028	X034
BN40		
BN41	X029	X035
BN42		
BN94	X030	X036

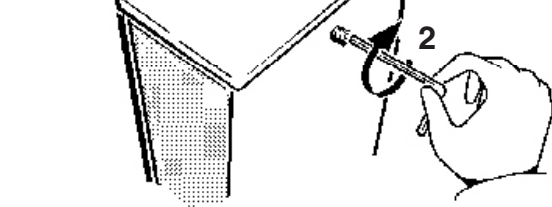

عرب يجب مراعاة عدم سحق الكيبلات الكهربائية عند غلق المنتج.

- I Richiudendo il prodotto evitare di schiacciare i cavi elettrici.
- GB When closing the product, do not compress the electrical cables.
- E Cuando cierre el producto, tenga cuidado de no aplastar los cables eléctricos.



عرب لا يمكن استعمال المنتج في حالة كسر الزجاج، وبالتالي يجب الاتصال بمصنعه لاستبداله.

- I In caso di rottura del vetro il prodotto non può essere utilizzato, contattare il costruttore per la sua sostituzione.
- GB Should the glass break, the product cannot be used and you should contact the manufacturer for its replacement.
- E No utilizar el producto en caso de ruptura del vidrio y contactar el fabricante para la sustitución.

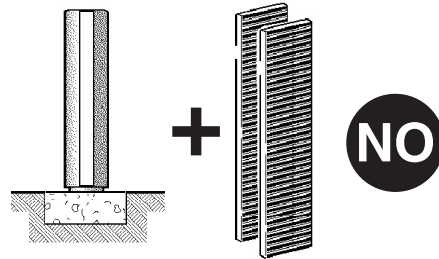
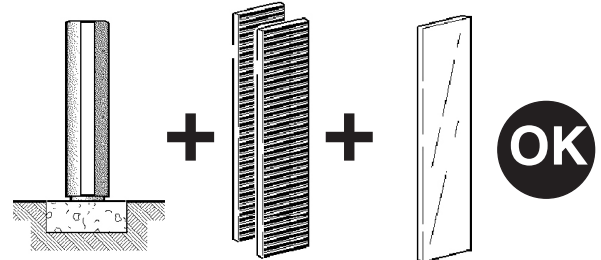

استبدال الضوء LED

SOSTITUZIONE DEL LED
REPLACING THE LED
REEMPLAZO DEL LED

عرب تشييه: لاستبدال الضوء LED اتصل بشركة iGuzzini

- I N.B.: Per la sostituzione del LED contattare l'azienda iGuzzini.
- GB N.B.: For information on LED replacement please contact iGuzzini.
- E NOTA: Para sustituir el LED llame a la empresa iGuzzini.

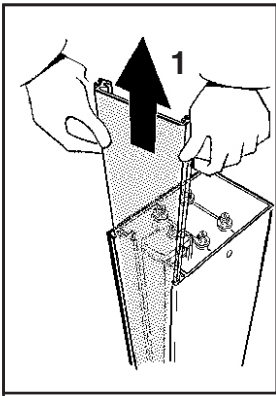

الصنف
art. X028 - X029
X030

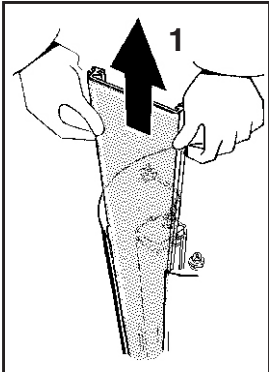
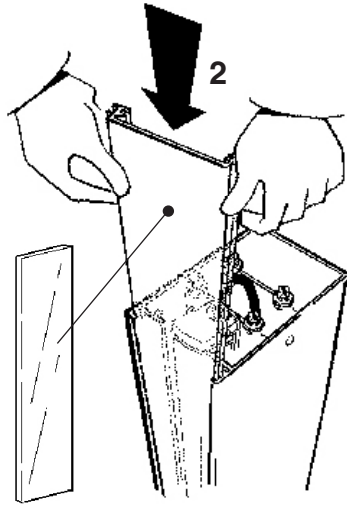

الصنف
art. X025 - X026 - X027

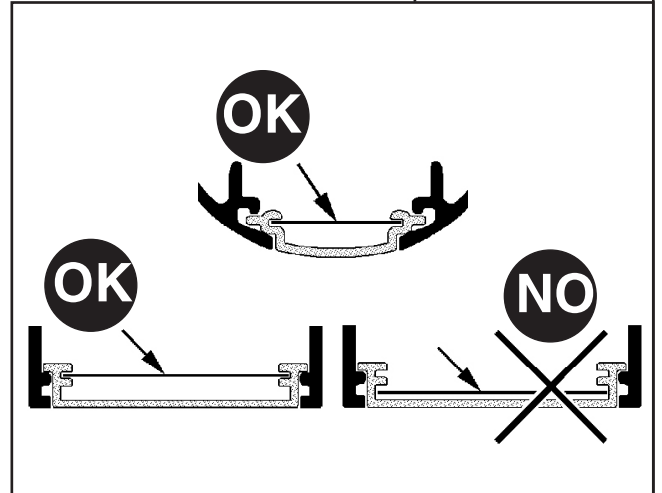
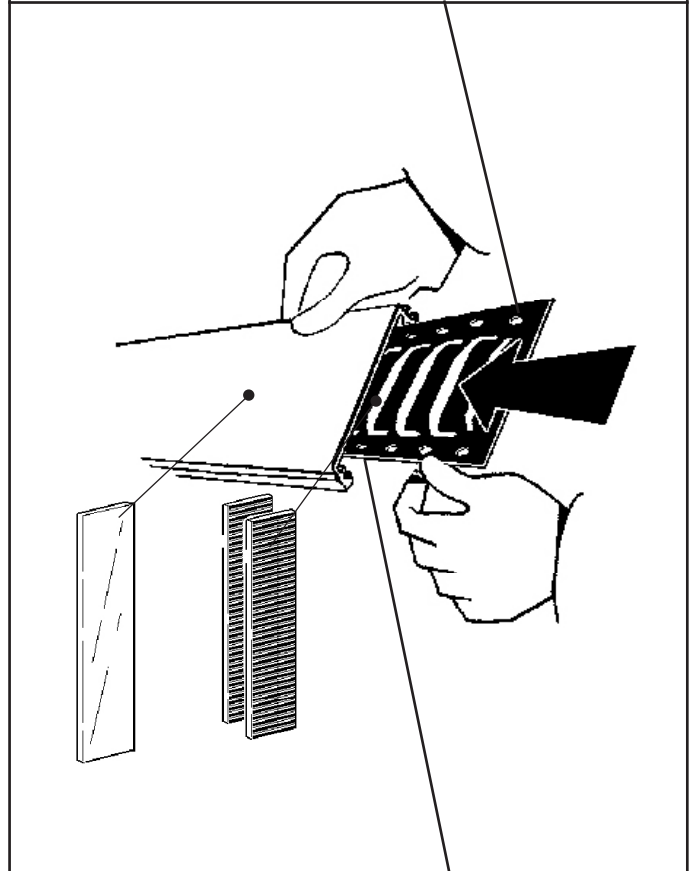
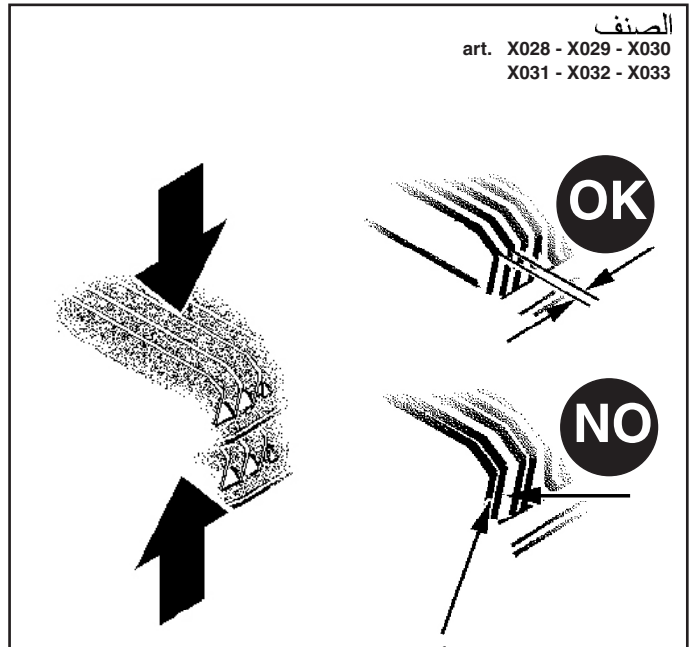
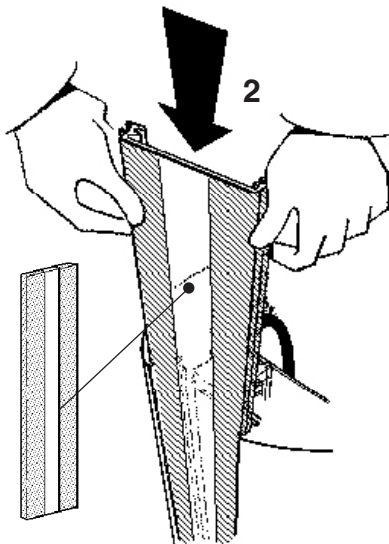

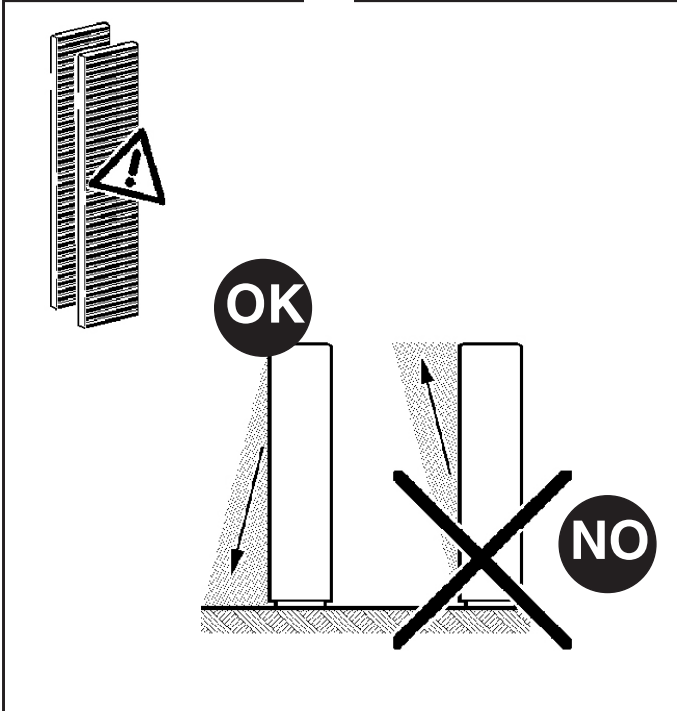
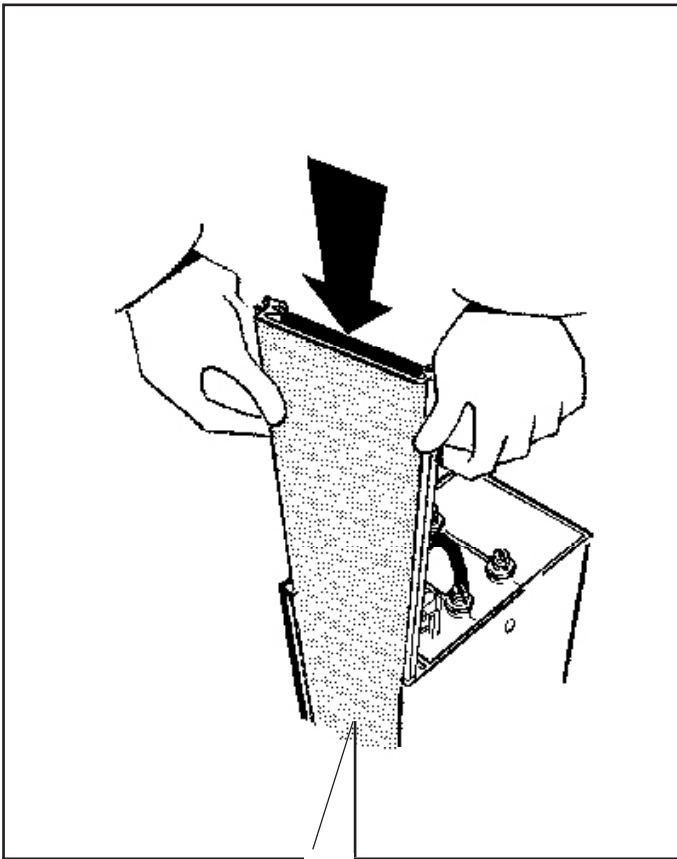

1.154.544.00

IS00766/05

SOSTITUZIONE DEL LED
REPLACING THE LED
REPLACEMENT DE LA LED
AUSTAUSCHEN DER LED
VERVANGEN VAN DE LED
REEMPLAZO DEL LED
UDSKIFTNING AF LYSDIODE
BYTE AV LYSDIOD
UTSKIFTING AV DEN LYSEMITTERENDE DIODEN
ЗАМЕНА СИДа
发光二极管替换

I N.B.: Per la sostituzione del LED contattare l'azienda iGuzzini.

GB N.B.: For information on LED replacement please contact iGuzzini.

F N.B.: Pour procéder au remplacement de la LED, adressez-vous à la société iGuzzini.

D N.B.: Bezüglich des Austausches der LED kontaktieren Sie bitte die Firma iGuzzini.

NL N.B.: Voor het vervangen van de LED neemt u contact op met het bedrijf iGuzzini.

E NOTA: Para sustituir el LED llame a la empresa iGuzzini.

DK N.B.: For udskiftning af lysdioden, skal man kontakte iGuzzini.

N N.B.: For informasjon om skifte av LED, vennligst ta kontakt med iGuzzini.

S OBS! För byte av lysdioden, kontakta företaget iGuzzini.

RUS ПРИМЕЧАНИЕ:Для замены СИДов обращайтесь в компанию iGuzzini.

CN 注意: 如需LED更换的信息, 请联系iGuzzini.

I Gruppo di rischio 1, secondo norma **EN 62471: 2008**
GB Risk Group: 1, in compliance with Standard **EN 62471: 2008**
FR Groupe de risque 1, suivant la norme **EN 62471 : 2008**
DE Risikogruppe 1, gemäß Vorschrift **EN 62471: 2008**
NL Risicogroep 1, volgens de norm **EN 62471: 2008**
E Grupo de riesgo 1, según norma **EN 62471: 2008**
DK Faregruppe 1 i henhold til standarden **EN 62471: 2008**
N Risikogruppe 1, i henhold til forskriften **EN 62471: 2008**
S Riskgrupp 1, enligt standard **EN 62471: 2008**
RUS ГРУПП РИСК 1 В СООТВЕТСТВИИ СО **EN 62471: 2008**

CN 风险组:1
灯具和灯具系统的光生物学安全性符合标准 **EN 62471: 2008**

iGuzzini

1.154.544.00

IS00766/05

SOSTITUZIONE DEL LED
REPLACING THE LED
REPLACEMENT DE LA LED
AUSTAUSCHEN DER LED
VERVANGEN VAN DE LED
REEMPLAZO DEL LED
UDSKIFTNING AF LYSDIODE
BYTE AV LYSDIOD
UTSKIFTING AV DEN LYSEMITTERENDE DIODEN
ЗАМЕНА СИДа
发光二极管替换

I N.B.: Per la sostituzione del LED contattare l'azienda iGuzzini.

GB N.B.: For information on LED replacement please contact iGuzzini.

F N.B.: Pour procéder au remplacement de la LED, adressez-vous à la société iGuzzini.

D N.B.: Bezüglich des Austausches der LED kontaktieren Sie bitte die Firma iGuzzini.

NL N.B.: Voor het vervangen van de LED neemt u contact op met het bedrijf iGuzzini.

E NOTA: Para sustituir el LED llame a la empresa iGuzzini.

DK N.B.: For udskiftning af lysdioden, skal man kontakte iGuzzini.

N N.B.: For informasjon om skifte av LED, vennligst ta kontakt med iGuzzini.

S OBS! För byte av lysdioden, kontakta företaget iGuzzini.

RUS ПРИМЕЧАНИЕ:Для замены СИДов обращайтесь в компанию iGuzzini.

CN 注意: 如需LED更换的信息, 请联系iGuzzini.

I Gruppo di rischio 1, secondo norma **EN 62471: 2008**
GB Risk Group: 1, in compliance with Standard **EN 62471: 2008**
FR Groupe de risque 1, suivant la norme **EN 62471 : 2008**
DE Risikogruppe 1, gemäß Vorschrift **EN 62471: 2008**
NL Risicogroep 1, volgens de norm **EN 62471: 2008**
E Grupo de riesgo 1, según norma **EN 62471: 2008**
DK Faregruppe 1 i henhold til standarden **EN 62471: 2008**
N Risikogruppe 1, i henhold til forskriften **EN 62471: 2008**
S Riskgrupp 1, enligt standard **EN 62471: 2008**
RUS ГРУПП РИСК 1 В СООТВЕТСТВИИ СО **EN 62471: 2008**

CN 风险组:1
灯具和灯具系统的光生物学安全性符合标准 **EN 62471: 2008**

iGuzzini

1.154.544.00

IS00766/05

SOSTITUZIONE DEL LED
REPLACING THE LED
REPLACEMENT DE LA LED
AUSTAUSCHEN DER LED
VERVANGEN VAN DE LED
REEMPLAZO DEL LED
UDSKIFTNING AF LYSDIODE
BYTE AV LYSDIOD
UTSKIFTING AV DEN LYSEMITTERENDE DIODEN
ЗАМЕНА СИДа
发光二极管替换

I N.B.: Per la sostituzione del LED contattare l'azienda iGuzzini.

GB N.B.: For information on LED replacement please contact iGuzzini.

F N.B.: Pour procéder au remplacement de la LED, adressez-vous à la société iGuzzini.

D N.B.: Bezüglich des Austausches der LED kontaktieren Sie bitte die Firma iGuzzini.

NL N.B.: Voor het vervangen van de LED neemt u contact op met het bedrijf iGuzzini.

E NOTA: Para sustituir el LED llame a la empresa iGuzzini.

DK N.B.: For udskiftning af lysdioden, skal man kontakte iGuzzini.

N N.B.: For informasjon om skifte av LED, vennligst ta kontakt med iGuzzini.

S OBS! För byte av lysdioden, kontakta företaget iGuzzini.

RUS ПРИМЕЧАНИЕ:Для замены СИДов обращайтесь в компанию iGuzzini.

CN 注意: 如需LED更换的信息, 请联系iGuzzini.

I Gruppo di rischio 1, secondo norma **EN 62471: 2008**
GB Risk Group: 1, in compliance with Standard **EN 62471: 2008**
FR Groupe de risque 1, suivant la norme **EN 62471 : 2008**
DE Risikogruppe 1, gemäß Vorschrift **EN 62471: 2008**
NL Risicogroep 1, volgens de norm **EN 62471: 2008**
E Grupo de riesgo 1, según norma **EN 62471: 2008**
DK Faregruppe 1 i henhold til standarden **EN 62471: 2008**
N Risikogruppe 1, i henhold til forskriften **EN 62471: 2008**
S Riskgrupp 1, enligt standard **EN 62471: 2008**
RUS ГРУПП РИСК 1 В СООТВЕТСТВИИ СО **EN 62471: 2008**

CN 风险组:1
灯具和灯具系统的光生物学安全性符合标准 **EN 62471: 2008**

iGuzzini

I PERIODO GIORNALIERO DI ACCENSIONE AMMESSO

GB ALLOWED DAILY OPERATION PERIOD

F DURÉE QUOTIDIENNE D'ALLUMAGE ADMISSIBLE

D ERLAUBTE TÄGLICHE EINSCHALTDAUER

NL DAGELIJKSE ONTSTEKINGSPERIODE TOEGESTAAN

E PERIODO DIARIO DE ENCENDIDO PERMITIDO

DK TILLADT TIDSRUM FOR DAGLIG TÆNDING

N TILLATT TENNINGSTID PR. DAG

S TILLÅTEN DAGLIG PERIOD SOM PRODUKTEN KAN VARA TÄND

RUS ЕЖЕДНЕВНАЯ ДОПУСТИМАЯ ПРОДОЛЖИТЕЛЬНОСТЬ РАБОТЫ

CN 允许的日常运营周期

iGuzzini

1.154.627.01
IS09175/01

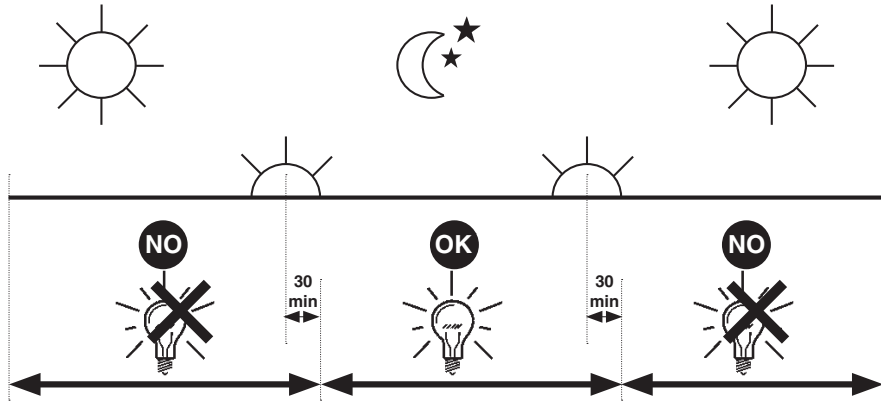

I PERIODO GIORNALIERO DI ACCENSIONE AMMESSO

GB ALLOWED DAILY OPERATION PERIOD

F DURÉE QUOTIDIENNE D'ALLUMAGE ADMISSIBLE

D ERLAUBTE TÄGLICHE EINSCHALTDAUER

NL DAGELIJKSE ONTSTEKINGSPERIODE TOEGESTAAN

E PERIODO DIARIO DE ENCENDIDO PERMITIDO

DK TILLADT TIDSRUM FOR DAGLIG TÆNDING

N TILLATT TENNINGSTID PR. DAG

S TILLÅTEN DAGLIG PERIOD SOM PRODUKTEN KAN VARA TÄND

RUS ЕЖЕДНЕВНАЯ ДОПУСТИМАЯ ПРОДОЛЖИТЕЛЬНОСТЬ РАБОТЫ

CN 允许的日常运营周期

iGuzzini

1.154.627.01
IS09175/01

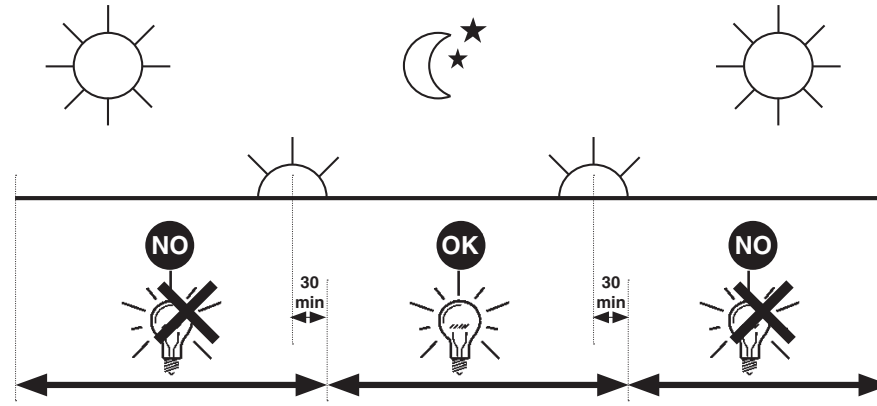

I PERIODO GIORNALIERO DI ACCENSIONE AMMESSO

GB ALLOWED DAILY OPERATION PERIOD

F DURÉE QUOTIDIENNE D'ALLUMAGE ADMISSIBLE

D ERLAUBTE TÄGLICHE EINSCHALTDAUER

NL DAGELIJKSE ONTSTEKINGSPERIODE TOEGESTAAN

E PERIODO DIARIO DE ENCENDIDO PERMITIDO

DK TILLADT TIDSRUM FOR DAGLIG TÆNDING

N TILLATT TENNINGSTID PR. DAG

S TILLÅTEN DAGLIG PERIOD SOM PRODUKTEN KAN VARA TÄND

RUS ЕЖЕДНЕВНАЯ ДОПУСТИМАЯ ПРОДОЛЖИТЕЛЬНОСТЬ РАБОТЫ

CN 允许的日常运营周期

iGuzzini

1.154.627.01
IS09175/01

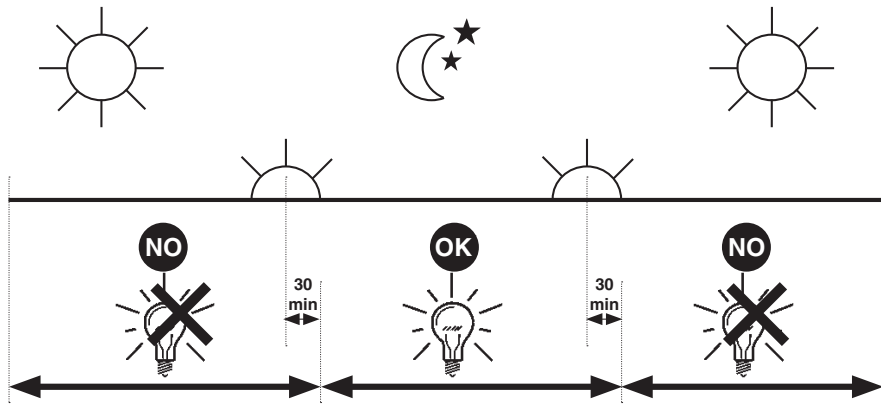

I PERIODO GIORNALIERO DI ACCENSIONE AMMESSO

GB ALLOWED DAILY OPERATION PERIOD

F DURÉE QUOTIDIENNE D'ALLUMAGE ADMISSIBLE

D ERLAUBTE TÄGLICHE EINSCHALTDAUER

NL DAGELIJKSE ONTSTEKINGSPERIODE TOEGESTAAN

E PERIODO DIARIO DE ENCENDIDO PERMITIDO

DK TILLADT TIDSRUM FOR DAGLIG TÆNDING

N TILLATT TENNINGSTID PR. DAG

S TILLÅTEN DAGLIG PERIOD SOM PRODUKTEN KAN VARA TÄND

RUS ЕЖЕДНЕВНАЯ ДОПУСТИМАЯ ПРОДОЛЖИТЕЛЬНОСТЬ РАБОТЫ

CN 允许的日常运营周期

iGuzzini

1.154.627.01
IS09175/01

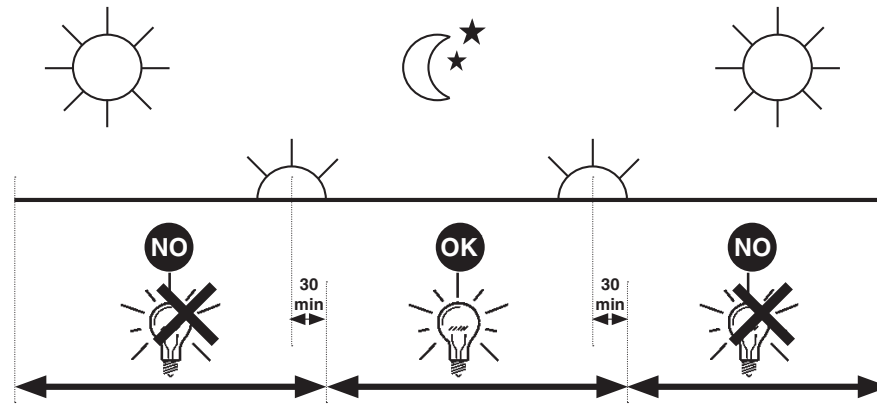

2.509.216.00
IS05718/01

استبدال الضوء LED
SOSTITUZIONE DEL LED
REPLACING THE LED
REEMPLAZO DEL LED

تنبیه: لاستبدال الضوء LED اتصل بشركة iGuzzini .

I N.B.: Per la sostituzione del LED contattare l'azienda iGuzzini.

GB N.B.: For information on LED replacement please contact iGuzzini.

E NOTA: Para sustituir el LED llame a la empresa iGuzzini.

فئة الخطر 1 . حسب مقاييس EN 62471: 2008 .

I Gruppo di rischio 1, secondo norma EN 62471: 2008

GB Risk Group: 1, in compliance with Standard EN 62471: 2008

E Grupo de riesgo 1, según norma EN 62471: 2008

iGuzzini

2.509.216.00
IS05718/01

استبدال الضوء LED
SOSTITUZIONE DEL LED
REPLACING THE LED
REEMPLAZO DEL LED

تنبیه: لاستبدال الضوء LED اتصل بشركة iGuzzini .

I N.B.: Per la sostituzione del LED contattare l'azienda iGuzzini.

GB N.B.: For information on LED replacement please contact iGuzzini.

E NOTA: Para sustituir el LED llame a la empresa iGuzzini.

فئة الخطر 1 . حسب مقاييس EN 62471: 2008 .

I Gruppo di rischio 1, secondo norma EN 62471: 2008

GB Risk Group: 1, in compliance with Standard EN 62471: 2008

E Grupo de riesgo 1, según norma EN 62471: 2008

iGuzzini

2.509.216.00
IS05718/01

استبدال الضوء LED
SOSTITUZIONE DEL LED
REPLACING THE LED
REEMPLAZO DEL LED

تنبیه: لاستبدال الضوء LED اتصل بشركة iGuzzini .

I N.B.: Per la sostituzione del LED contattare l'azienda iGuzzini.

GB N.B.: For information on LED replacement please contact iGuzzini.

E NOTA: Para sustituir el LED llame a la empresa iGuzzini.

فئة الخطر 1 . حسب مقاييس EN 62471: 2008 .

I Gruppo di rischio 1, secondo norma EN 62471: 2008

GB Risk Group: 1, in compliance with Standard EN 62471: 2008

E Grupo de riesgo 1, según norma EN 62471: 2008

iGuzzini

2.509.216.00
IS05718/01

استبدال الضوء LED
SOSTITUZIONE DEL LED
REPLACING THE LED
REEMPLAZO DEL LED

تنبیه: لاستبدال الضوء LED اتصل بشركة iGuzzini .

I N.B.: Per la sostituzione del LED contattare l'azienda iGuzzini.

GB N.B.: For information on LED replacement please contact iGuzzini.

E NOTA: Para sustituir el LED llame a la empresa iGuzzini.

فئة الخطر 1 . حسب مقاييس EN 62471: 2008 .

I Gruppo di rischio 1, secondo norma EN 62471: 2008

GB Risk Group: 1, in compliance with Standard EN 62471: 2008

E Grupo de riesgo 1, según norma EN 62471: 2008

iGuzzini

2.509.216.00
IS05718/01

استبدال الضوء LED
SOSTITUZIONE DEL LED
REPLACING THE LED
REEMPLAZO DEL LED

تنبیه: لاستبدال الضوء LED اتصل بشركة iGuzzini .

I N.B.: Per la sostituzione del LED contattare l'azienda iGuzzini.

GB N.B.: For information on LED replacement please contact iGuzzini.

E NOTA: Para sustituir el LED llame a la empresa iGuzzini.

فئة الخطر 1 . حسب مقاييس EN 62471: 2008 .

I Gruppo di rischio 1, secondo norma EN 62471: 2008

GB Risk Group: 1, in compliance with Standard EN 62471: 2008

E Grupo de riesgo 1, según norma EN 62471: 2008

iGuzzini

iGuzzini

2.509.386.00
ISO9176/01

الفترة الزمنية اليومية للتشغيل المسموح بها

- I PERIODO GIORNALIERO DI ACCENSIONE AMMESSO
- GB ALLOWED DAILY OPERATION PERIOD
- E PERIODO DIARIO DE ENCENDIDO PERMITIDO



iGuzzini

2.509.386.00
ISO9176/01

الفترة الزمنية اليومية للتشغيل المسموح بها

- I PERIODO GIORNALIERO DI ACCENSIONE AMMESSO
- GB ALLOWED DAILY OPERATION PERIOD
- E PERIODO DIARIO DE ENCENDIDO PERMITIDO



iGuzzini

2.509.386.00
ISO9176/01

الفترة الزمنية اليومية للتشغيل المسموح بها

- I PERIODO GIORNALIERO DI ACCENSIONE AMMESSO
- GB ALLOWED DAILY OPERATION PERIOD
- E PERIODO DIARIO DE ENCENDIDO PERMITIDO



iGuzzini

2.509.386.00
ISO9176/01

الفترة الزمنية اليومية للتشغيل المسموح بها

- I PERIODO GIORNALIERO DI ACCENSIONE AMMESSO
- GB ALLOWED DAILY OPERATION PERIOD
- E PERIODO DIARIO DE ENCENDIDO PERMITIDO



- I Istruzioni per le operazioni di servizio per l'apparecchio di illuminazione**
GB Instructions on luminaire service operations
F Instructions pour les opérations de service du luminaire
D Wartungsanleitung für die Leuchte
NL Instructies voor de onderhoudsoperaties op de verlichtingsarmatuur
E Instrucciones para las operaciones de servicio del aparato de alumbrado
DK Anvisninger i serviceindgreb på belysningsarmatur
N Anvisninger for betjening av lysapparatet
S Instruktioner för användning av belysningsanordningen
RUS Инструкция по эксплуатации осветительного прибора
CN 照明装置检修操作说明

Sostituire la lampada parzialmente esausta
 Replace the partly exhausted lamp
 Remplacer la lampe partiellement épuisée
 Die teilweise erschöpfte Lampe austauschen
 Vervang de gedeeltelijk lege lamp
 Sustituir la lámpara parzialmente agotada
 Udskift den delvist udtjente pære
 Skifte ut den delvis utbrente lyspæren
 Byt ut den delvis förbrukade lampan
 Замена частично отработанной лампочки
 更换部分老化的灯泡



Spegnimento
 Switch it off
 Extinction
 Ausschaltung
 Uitschakeling
 Apagado
 Slukning
 Slukking
 Släckning
 Выключение
 关灯

Interrompere l'alimentazione dell'apparecchio
 Cut the power supply to the luminaire
 Couper l'alimentation du luminaire
 Stromversorgung der Leuchte unterbrechen
 Onderbreek de voeding van het apparaat
 Interrumpir la alimentación del aparato
 Afbryd armaturets strømforsyning
 Avbryte strømtilførselen til apparatet
 Koppla från anordningens strömförsörjning
 Отключить электропитание прибора
 中断装置供电



Aprire l'apparecchio
 Open the fixture
 Ouvrir le luminaire
 Das Gerät öffnen
 Open het apparaat
 Abrir el aparato
 Åbn armaturet
 Åpne apparatet
 Öppna anordningen
 Раскрыть прибор
 打开装置



Rimuovere la lampada esausta
 Remove the exhausted lamp
 Retirer la lampe épuisée
 Die alte Lampe entnehmen
 Verwijder de lege lamp
 Quitar la lámpara agotada
 Tag den udtjente pære ud
 Fjerne den utbrente lyspæren
 Ta bort den förbrukade lampan
 Вынуть старую лампочку
 取出老化的灯泡

Portarla in un centro di riciclaggio
 Carry it to a recycling centre
 La porter dans une déchetterie pour son recyclage
 Ordnungsgemäß entsorgen
 Breng de lamp naar een recyclingcentrum
 Llevarla a un centro de reciclaje
 Aflever den på en genbrugsstation
 Lever den til en miljøstasjon
 Lämna in den till en återvinningsanläggning
 Сдать ее в пункт приема утильсырья
 将其送往回收中心



Inserire la nuova lampada
 Introduce the new lamp
 Installer la lampe neuve
 Die neue Lampe einsetzen
 Doe de nieuwe lamp op zijn plek
 Montar la nueva lámpara
 Sæt den nye pære i
 Sette i den nye pæren
 Sätt i den nya lampan
 Вставить новую лампочку
 装入新灯泡

Inserire la nuova lampada nel portalampana
 Fit the new lamp into the socket
 Installer la nouvelle lampe dans le support de lampe
 Die neue Lampe in den Sockel einsetzen
 Doe de nieuwe lamp in de lamphouder
 Montar la nueva lámpara en el portalampana
 Sæt den nye pære i fatningen
 Sette den nye pæren inn i lampeholderen
 Sätt i den nya lampan i lamphållaren
 Вставить новую лампочку в патрон
 将新灯泡插入灯泡架中



Riposizionare ottica
 Re-place the optic
 Remettre l'optique à sa place
 Die Optik wieder einsetzen
 Doe de optiek weer op zijn plaats
 Volver a montar la óptica
 Sæt den optiske enhed på plads
 Innstille linsen
 Flytta om optiken
 Отрегулировать линзы
 重新定位光头



Effettuare prova di funzionamento
 Perform operative test
 Procéder à un essai de fonctionnement
 Eine Funktionsprüfung durchführen
 Controleer de correcte werking
 Hacer una prueba de funcionamiento
 Afprøv funktionen
 Prøve om den fungerer
 Utför funktionstest
 Выполнить проверку исправности работы
 执行功能测试



I Istruzioni per la pulizia dell'apparecchio di illuminazione
GB Instructions on luminaire cleaning operations
F Instructions pour le nettoyage du luminaire
D Anweisungen zur Reinigung der Leuchte
NL Instructies voor de reiniging van de verlichtingsarmatuur
E Instrucciones para limpiar el aparato de alumbrado
DK Anvisninger i rengøring af belysningsarmaturet
N Anvisninger for rengjøring av lysapparatet
S Instruktioner för rengöring av belysningsanordningen
RUS Инструкции по чистке осветительного прибора
CN 照明装置清洁说明

Pulire l'apparecchio
Clean the fixture
Nettoyer le luminaire
Das Gerät reinigen
Reinig het apparaat
Limpiar el aparato
Rengør armaturet
Rengjøre apparatet
Rengör anordningen
Чистка прибора
清洁装置



Spegnimento
Switch it off
Extinction
Ausschaltung
Uitschakeling
Apagado
Slukning
Slukking
Släckning
Выключение
关灯

Interrompere l'alimentazione dell'apparecchio
Cut the power supply to the luminaire
Couper l'alimentation du luminaire
Stromversorgung der Leuchte unterbrechen
Onderbreek de voeding van het apparaat
Interrumpir la alimentación del aparato
Afbryd armaturets strømforstyrning
Avbryt strømtilførselen til apparatet
Koppla från anordningens strömförsörjning
Отключить электропитание прибора
中断装置供电



Spolverare l'ottica esterna
Remove dust from the external optic
Dépoussiérer l'optique extérieure
Die externe Optik abstauben
Stof de externe optiek af
Quitar el polvo de la óptica exterior
Tør støvet af den udvendige optiske enhed
Fjerne støv fra den eksterne lysenheden
Damma av den yttre optiken
Вытереть пыль с внешней стороны линз
为外侧镜头掸尘



Lavare l'ottica esterna
Wash the external optic
Laver l'optique extérieure
Die externe Optik waschen
Was de externe optiek
Lavar la óptica exterior
Vask den udvendige optiske enhed
Vaske den eksterne lysenheden
Rengör den yttre optiken
Вымыть линзы с внешней стороны
清洁外镜头



Rimuovere l'ottica
Remove the optic
Retirer l'optique
Die Optik abnehmen
Verwijder de optiek
Quitar la óptica
Tag den optiske enhed af
Fjerne lysenheden
Ta bort optiken
Снять линзы
取下镜头



Pulire la parte interna dell'apparecchio di illuminazione
Clean the inside of the fixture
Nettoyer l'intérieur du luminaire
Die Innenseite der Leuchte reinigen
Reinig de binnenzijde van de verlichtingsarmatuur
Limpiar el interior del aparato de alumbrado
Rengør belysningsarmaturets indvendige dele
Rengjøre lysapparatet innvendig
Rengör belysningsanordningen invändigt
Протереть осветительный прибор изнутри
清洁照明装置内部



Riposizionare ottica
Re-place the optic
Remettre l'optique à sa place
Die Optik wieder einsetzen
Doe de optiek weer op zijn plaats
Volver a montar la óptica
Sæt den optiske enhed på plads
Innstille linsen
Flytta om optiken
Отрегулировать линзы
重新定位镜头



Effettuare prova di funzionamento
Perform operative test
Procéder à un essai de fonctionnement
Eine Funktionsprüfung durchführen
Controleer de correcte werking
Hacer una prueba de funcionamiento
Afprøv funktionen
Prøve om den fungerer
Utför funktionstest
Выполнить проверку исправности работы
执行功能测试



- I** Istruzioni per il fine vita e lo smaltimento dei componenti
GB Instructions on end-of-life and component disposal
F Instructions pour la gestion des composants en fin de vie et leur mise au rebut
D Anweisungen zur Entsorgung der Leuchtenkomponenten
NL Instructies voor het verwijderen van de armatuur en het recyclen van de onderdelen
E Instrucciones para el final de vida y la eliminación los componentes
DK Anvisninger i udtjent armatur og bortskaffelse af komponenter
N Anvisninger for endt levetid og avfallsbehandling av delene
S Instruktioner vid bortskaffning och kassering av komponenter
RUS Инструкции по утилизации прибора и его комплектующих по окончании его срока службы
CN 寿命期结束与零件废弃处置说明

<p>Spegnimento Switch it off Extinction Ausschaltung Uitschakeling Apagado Slukning Slukking Släckning Выключение 关灯</p> <p>Interrompere l'alimentazione dell'apparecchio Cut the power supply to the luminaire Couper l'alimentation du luminaire Stromversorgung der Leuchte unterbrechen Onderbreek de voeding van het apparaat Interrompirla alimentación del aparato Afbryd armaturets strømforsyning Avbryt strømtilførselen til apparatet Koppla från anordningens strömförsörjning Отключить электропитание прибора 中断装置供电</p> 	<p>Rimuovere la/e lampada/e per la dismissione Remove the lamp(s) for decommissioning Retirer la(les) lampe(s) pour sa(leur) mise au rebut Die Lampe/n ordnungsgemäß entsorgen Verwijder de lamp(en) voor het recyclen Quitar la(s) lámpara(s) para el desecho Tag pæren/pærerne ud til bortskaffelse Fjerne lampen/-e som skal kastes Ta bort lampan/-orna för bortskaffningen Вынуть лампочку/и для утилизации прибора 取出需要丢弃的灯泡</p> 	<p>Rimuovere la batteria per la dismissione Remove the battery for decommissioning Retirer la batterie pour sa mise au rebut Die Batterie ordnungsgemäß entsorgen Verwijder de batterij voor het recyclen Quitar la batería para el desecho Tag batteriet ud til bortskaffelse Fjerne batteriet som skal kastes Ta bort batteriet för bortskaffningen Вынуть батарейку для утилизации прибора 取出需要丢弃的电池</p> 	<p>Rimuovere l'apparecchio per la dismissione Remove the fixture for decommissioning Enlever le luminaire pour sa mise au rebut Das Gerät ordnungsgemäß entsorgen Verwijder het apparaat voor het recyclen Quitar el aparato para el desecho Tag armaturet ud til bortskaffelse Fjerne apparatet som skal kastes Ta bort anordningen för bortskaffningen Снять прибор для утилизации 取出需要丢弃的装置</p> 
---	--	--	--

<p>Inviare i materiali ad un centro di raccolta RAEE Send the materials to a WEEE collection centre Envoyer les matériaux dans une déchetterie DEEE Die Materialien in einem WEEE-Zentrum entsorgen Zend de materialen naar een recyclingscentrum voor de AEEA Enviar los materiales a un centro de recogida RAEE Afløver materialerne på et indsamlingscenter for elektronisk udstyr Sende materialene til en miljøstasjon for resirkulering av EE-avfall Skicka materialet till en RAEE uppsamlingscentral Сдать материалы в пункт приема утильсырья 将材料送往电气和电子垃圾回收中心</p> 			
--	--	--	--