

**FOGLIO D'ISTRUZIONI**

**INSTRUCTIONS FOR USE**

**ATTENZIONE:**

LA SICUREZZA DELL'APPARECCHIO E' GARANTITA SOLO CON L'USO APPROPRIATO DELLE SEGUENTI ISTRUZIONI; PERTANTO E' NECESSARIO CONSERVARLE.

**WARNING:**

SAFETY OF THE DEVICE IS ONLY GUARANTEED WITH APPROPRIATE USE OF THE FOLLOWING INSTRUCTIONS; IT IS THEREFORE NECESSARY TO KEEP THEM FOR FUTURE REFERENCE.

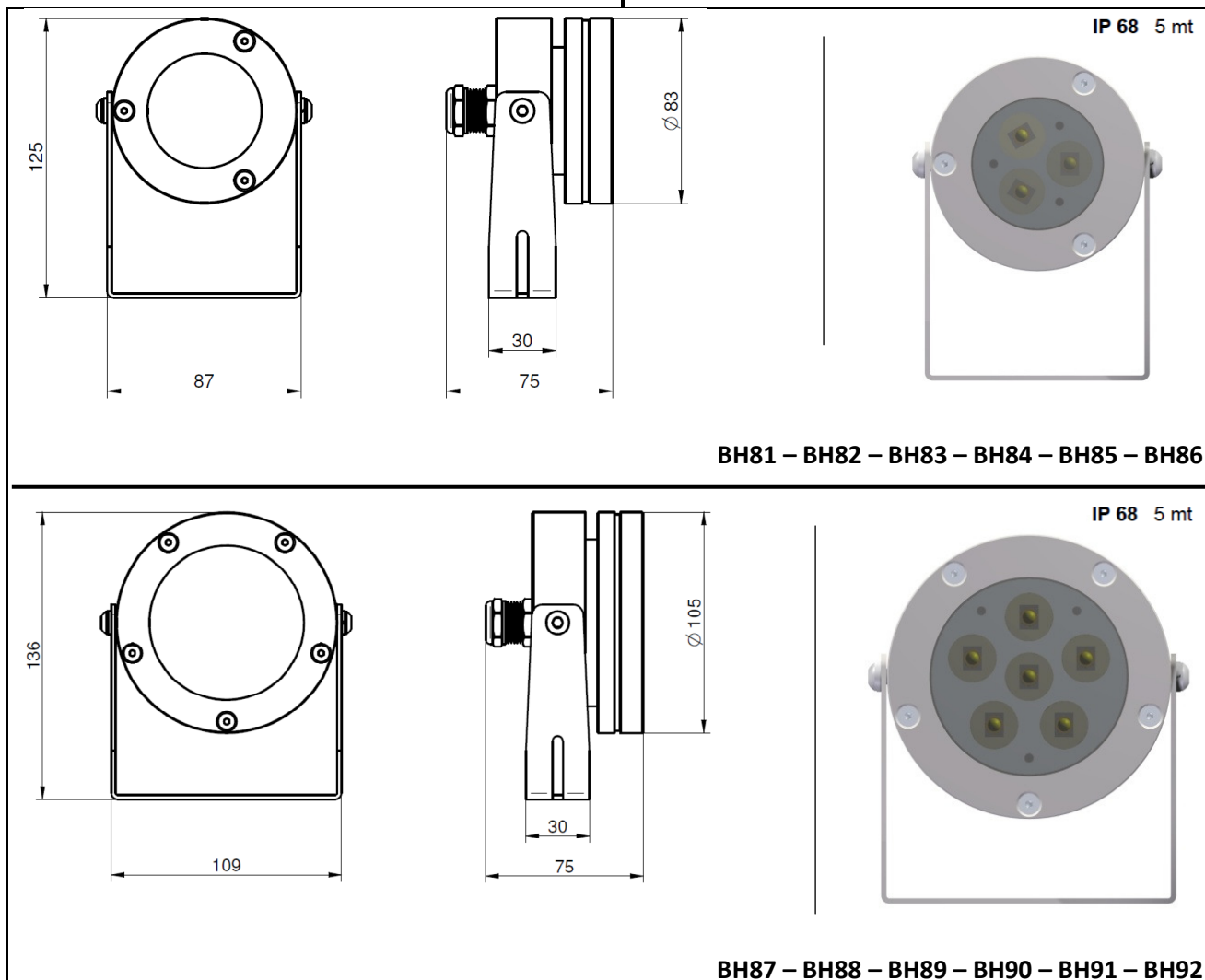

**APPLICAZIONE:**

APPARECCHIO A LED **DA IMMERSIONE PERMANENTE** PER L'ILLUMINAZIONE DI PISCINE PUBBLICHE E PRIVATE. ADATTO PER VASCHE RIVESTITE IN MURATURA O CON TELO SINTETICO (PREVIO L'UTILIZZO DEL KIT ACCESSORIO).

**PURPOSE:**

**PERMANENT IMMERSION** LED DEVICE FOR PUBLIC AND PRIVATE SWIMMING POOLS LIGHTING. SUITABLE FOR CONCRETE OR SYNTHETIC LINER POOLS (PROVIDED THE ACCESSORY KIT IS USED).

#### **ALIMENTAZIONE:**

- *QUESTO APPARECCHIO ALIMENTATO IN DC NECESSITA DI UN GRUPPO DI ALIMENTAZIONE ESTERNO DI SICUREZZA SECONDO LA VIGENTE NORMA EN 60598-2-18. SELV.EQUIV.SELV.*
- *DETTO GRUPPO DOVRA' ESSERE ALLOGGIATO IN AMBIENTE ADEGUATO E PROTETTO SECONDO QUANTO PREVISTO DALLE NORME IMPIANTISTICHE NAZIONALI VIGENTI.*

#### **SICUREZZA:**

- *PER L'INSTALLAZIONE E L'IMPIEGO DI QUESTO PRODOTTO RISPETTARE LE NORME DI SICUREZZA NAZIONALI.*
- *PER L'INSTALLAZIONE DI QUESTO PRODOTTO NON E' RICHIESTA L'APERTURA DELL'APPARECCHIO IN NESSUNA DELLE SUE PARTI PERTANTO TUTTE LE MODIFICHE APPORTATE ALLO STESSO VENGONO EFFETTUATE SOTTO LA RESPONSABILITA' ESCLUSIVA DI COLUI CHE LE EFFETTUERA'.*
- *ANCHE NEL CASO IN CUI IL PRODOTTO PRESENTI PROBLEMI NON LO SI DEVE APRIRE O SMONTARE. L'AZIENDA PROVVEDERA' ALLA SOSTITUZIONE IN GARANZIA SOLO SE L'APPARECCHIO DA SOSTITUIRE SARA' INTEGRO.*

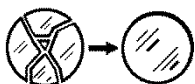

#### **NOTE:**

- *Sostituire lo schermo di protezione danneggiato. Richiedere le specifiche tecniche al costruttore. Non utilizzare l'apparecchio senza lo schermo*
- *Per la sostituzione dello schermo contattare IGUZZINI*

#### **POWER SUPPLY:**

- *THIS DEVICE WITH DC POWER REQUIRES AN EMERGENCY EXTERNAL POWER UNIT IN ACCORDANCE WITH THE EN 60598-2-18 REGULATION. SELV.EQUIV.SELV.*
- *SAID UNIT MUST BE PLACED IN AN APPROPRIATE PROTECTED SPACE IN ACCORDANCE WITH NATIONAL REGULATIONS ON INSTALLATIONS.*

#### **SAFETY:**

- *NATIONAL REGULATIONS ON SAFETY MUST BE COMPLIED WITH DURING THE INSTALLATION AND USE OF THIS PRODUCT.*
- *THE INSTALLATION OF THIS PRODUCT DOES NOT REQUIRE OPENING THE DEVICE OR ANY OF ITS PARTS, THEREFORE IF ANY MODIFICATIONS ARE OPERATED TO IT THE PERSON WHO MADE THEM WILL TAKE FULL RESPONSIBILITY.*
- *EVEN IN CASE OF MALFUNCTION DO NOT OPEN OR DISMANTLE THE PRODUCT. THE COMPANY WILL REPLACE IT UNDER WARRANTY ONLY IF THE DEVICE IS UNALTERED.*

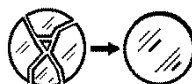

#### **NOTES:**

- *Replace the damaged protective screen, requesting the technical specifications from the manufacturer. Do not use the luminaire without the screen.*
- *To replace it, please contact IGUZZINI*

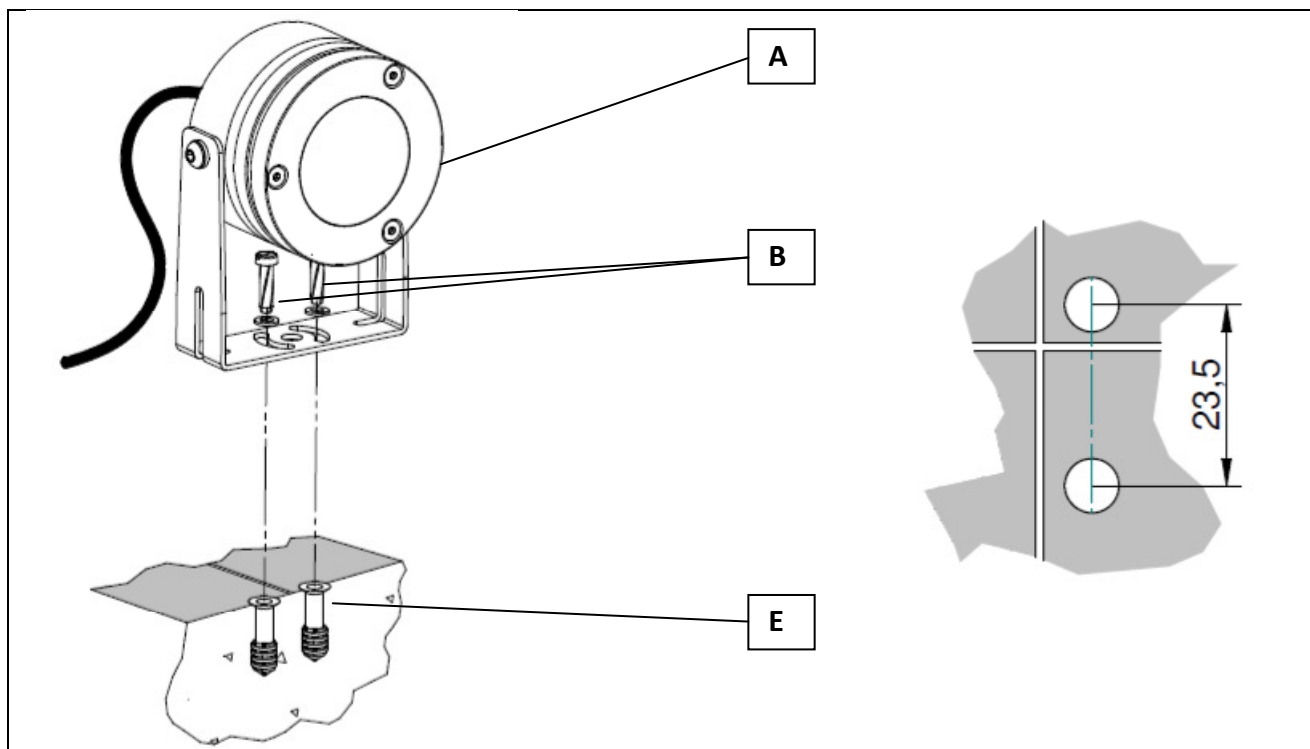

#### **INSTALLAZIONE PRODOTTO:**

- *PREDISPORRE FORATURE PER FISCHER (E)*
- *POSIZIONARE L'APPARECCHIO (A) CON LE ASOLE IN CORRISPONDENZA DEI FISCHER*
- *SCEGLIERE IL GRADO DI ROTAZIONE DESIDERATO E BLOCCARE L'APPARECCHIO (A) UTILIZZANDO LA VITERIA IN DOTAZIONE (B)*

#### **PRODUCT INSTALLATION:**

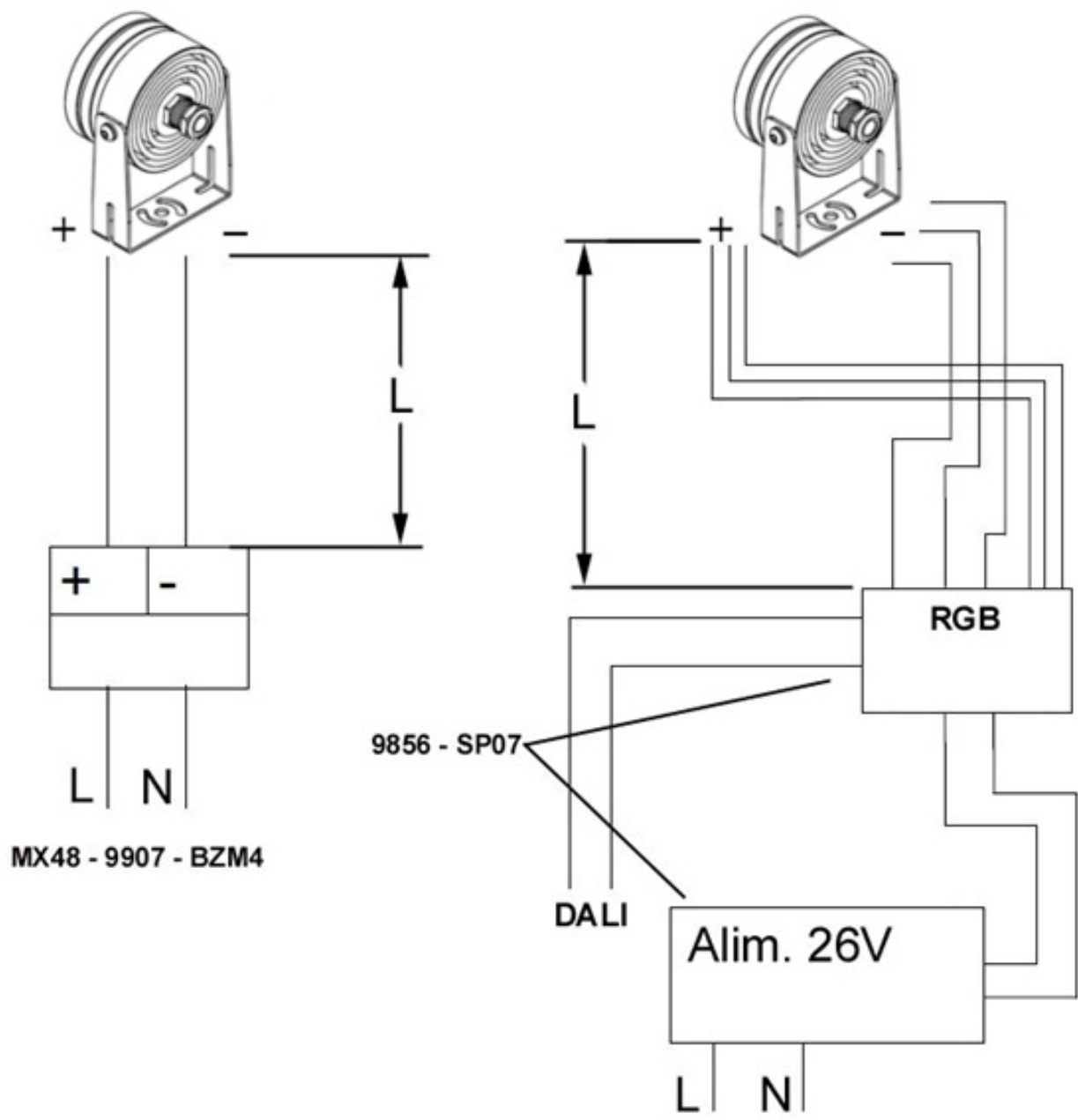

- *PREPARE HOLES FOR THE FISCHER (E)*
- *POSITION THE DEVICE (A) WITH THE EYELET IN CORRISPONDENCE TO THE FIXING SISTEM*
- *CHOOSE THE DESIRED DEGREE OF ROTATION AND BLOCK THE UNIT (A) USING THE SCREWS PROVIDED (B)*



MX48 - 9907 - BZM4

	Prodotti installabili Lmax 50Mt	
	BH81	BH87
	BH82	BH88
	BH83	BH89
	BH84	BH90
	(3W)	(6W)
MX48	2	NO
9907	3	NO
BZM4 *	5	3



Posizioni Switch per BZM4	
350mA	700mA
BH81	BH87
BH82	BH88
BH83	BH89
BH84	BH90
	

\*Modificare la posizione degli switch come indicato in tabella a seconda del prodotto da alimentare

\*Modify the position of the switches as stated in the table, according to the product to feed



**NO DIRECT DIM / NO DALI**

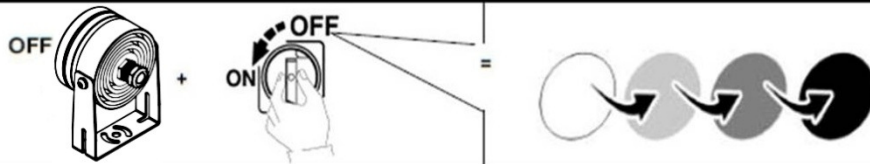

**DIRECT DIM**

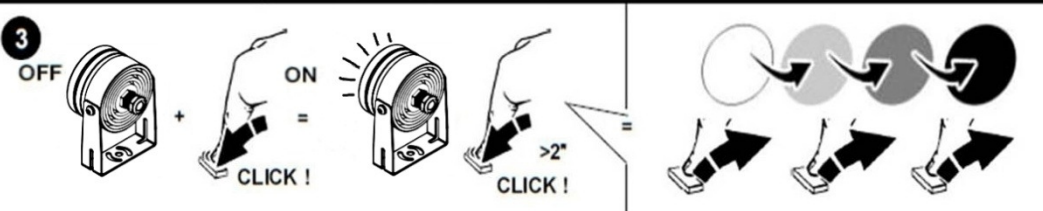
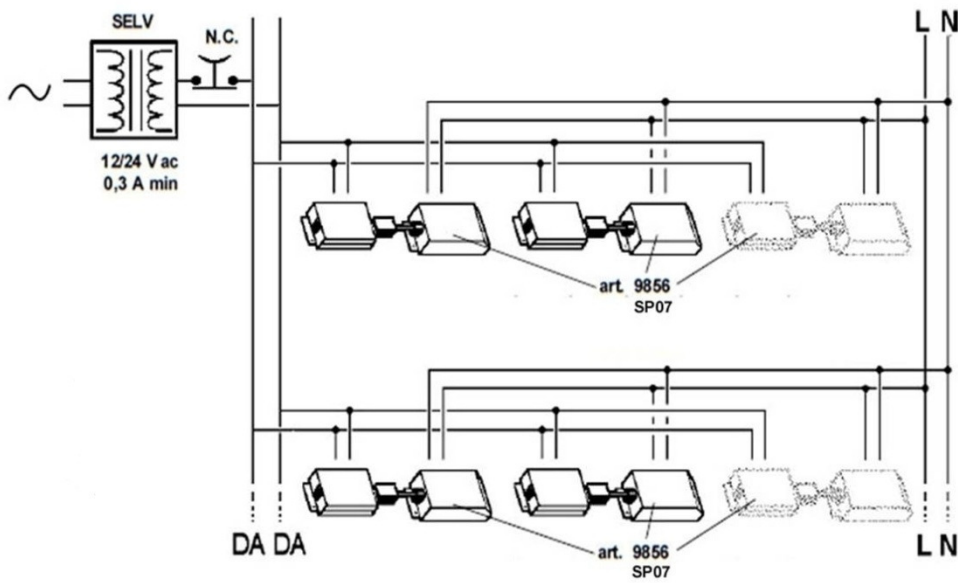

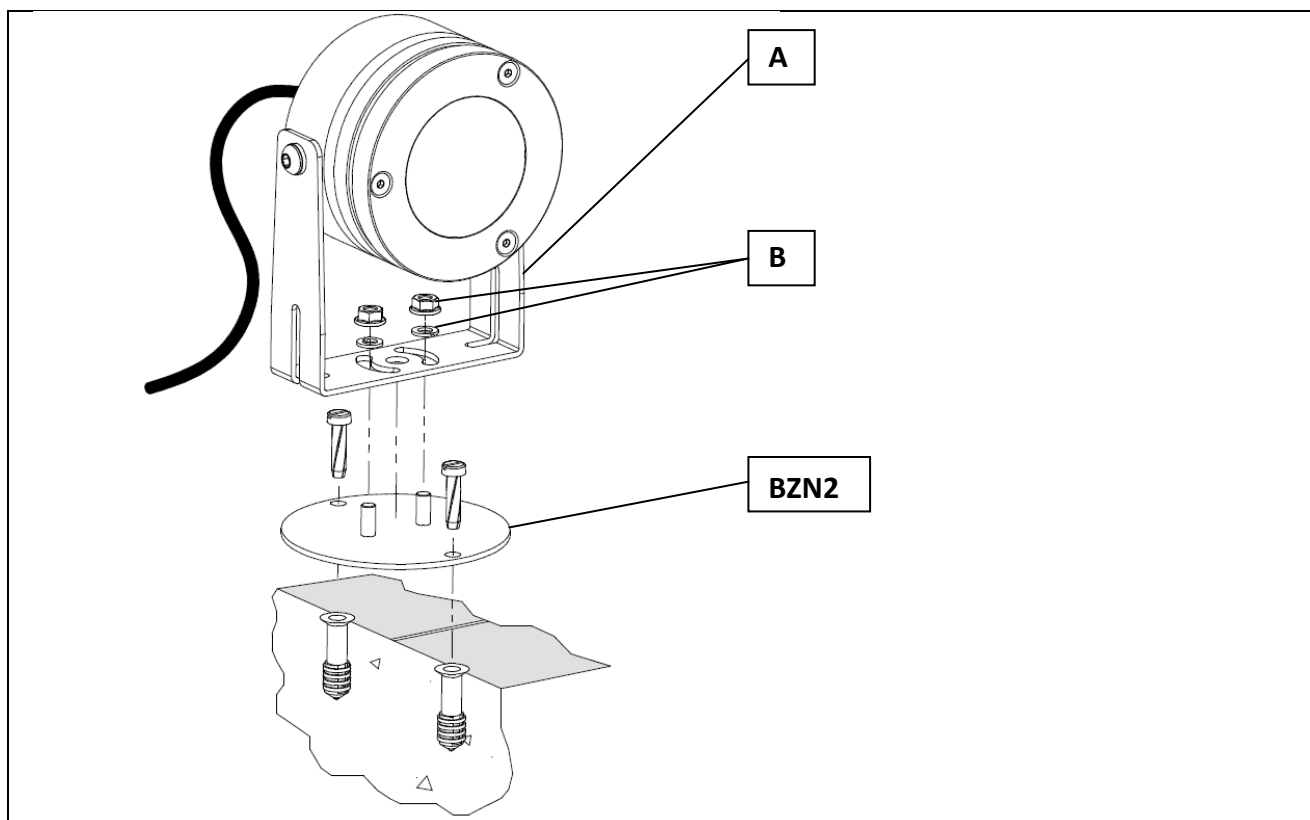

#### **INSTALLAZIONE ART. BZN2:**

- *PREDISPORRE FORATURE PER FISCHER*
- *AVVITARE AL SUOLO LA CONTROPIASTRA ART.BZN2*
- *POSIZIONARE IL PROIETTORE (A) INSERENDO LA STAFFA NEI PERNI DELLA CONTROPIASTRA.*
- *SCEGLIERE IL GRADO DI ROTAZIONE DESIDERATO E BLOCCARE L'APPARECCHIO (A) UTILIZZANDO LA VITERIA IN DOTAZIONE (B)*

#### **ART. BZN2 INSTALLATION:**

- *PREPARE HOLES FOR THE FISCHER*
- *FIX THE BACKPLATE ART.BZN2 TO THE GROUND*
- *POSITION THE PROJECTOR (A) BY INSERTING IN THE BRACKET OF PINS BACKPLATE*
- *CHOOSE THE DESIRED DEGREE OF ROTATION AND BLOCK THE UNIT (A) USING THE SCREWS PROVIDED (B)*

1.154.544.00

IS00766/05

**SOSTITUZIONE DEL LED**  
**REPLACING THE LED**  
**REPLACEMENT DE LA LED**  
**AUSTAUSCHEN DER LED**  
**VERVANGEN VAN DE LED**  
**REEMPLAZO DEL LED**  
**UDSKIFTNING AF LYSDIODE**  
**BYTE AV LYSDIOD**  
**UTSKIFTING AV DEN LYSEMITTERENDE DIODEN**  
**ЗАМЕНА СИДа**  
**发光二极管替换**

**I N.B.:** Per la sostituzione del LED contattare l'azienda iGuzzini.

**GB N.B.:** For information on LED replacement please contact iGuzzini.

**F N.B.:** Pour procéder au remplacement de la LED, adressez-vous à la société iGuzzini.

**D N.B.:** Bezüglich des Austausches der LED kontaktieren Sie bitte die Firma iGuzzini.

**NL N.B.:** Voor het vervangen van de LED neemt u contact op met het bedrijf iGuzzini.

**E NOTA:** Para sustituir el LED llame a la empresa iGuzzini.

**DK N.B.:** For udskiftning af lysdioden, skal man kontakte iGuzzini.

**N N.B.:** For informasjon om skifte av LED, vennligst ta kontakt med iGuzzini.

**S OBS!** För byte av lysdioden, kontakta företaget iGuzzini.

**RUS ПРИМЕЧАНИЕ:**Для замены СИДов обращайтесь в компанию iGuzzini.

**CN 注意:** 如需LED更换的信息, 请联系iGuzzini.

**I** Gruppo di rischio 1, secondo norma **EN 62471: 2008**  
**GB** Risk Group: 1, in compliance with Standard **EN 62471: 2008**  
**FR** Groupe de risque 1, suivant la norme **EN 62471 : 2008**  
**DE** Risikogruppe 1, gemäß Vorschrift **EN 62471: 2008**  
**NL** Risicogroep 1, volgens de norm **EN 62471: 2008**  
**E** Grupo de riesgo 1, según norma **EN 62471: 2008**  
**DK** Faregruppe 1 i henhold til standarden **EN 62471: 2008**  
**N** Risikogruppe 1, i henhold til forskriften **EN 62471: 2008**  
**S** Riskgrupp 1, enligt standard **EN 62471: 2008**  
**RUS** GROUP РИСК 1 В СООТВЕТСТВИИ СО **EN 62471: 2008**

**CN** 风险组:1  
灯具和灯具系统的光生物学安全性符合标准 **EN 62471: 2008**

**iGuzzini**

1.154.544.00

IS00766/05

**SOSTITUZIONE DEL LED**  
**REPLACING THE LED**  
**REPLACEMENT DE LA LED**  
**AUSTAUSCHEN DER LED**  
**VERVANGEN VAN DE LED**  
**REEMPLAZO DEL LED**  
**UDSKIFTNING AF LYSDIODE**  
**BYTE AV LYSDIOD**  
**UTSKIFTING AV DEN LYSEMITTERENDE DIODEN**  
**ЗАМЕНА СИДа**  
**发光二极管替换**

**I N.B.:** Per la sostituzione del LED contattare l'azienda iGuzzini.

**GB N.B.:** For information on LED replacement please contact iGuzzini.

**F N.B.:** Pour procéder au remplacement de la LED, adressez-vous à la société iGuzzini.

**D N.B.:** Bezüglich des Austausches der LED kontaktieren Sie bitte die Firma iGuzzini.

**NL N.B.:** Voor het vervangen van de LED neemt u contact op met het bedrijf iGuzzini.

**E NOTA:** Para sustituir el LED llame a la empresa iGuzzini.

**DK N.B.:** For udskiftning af lysdioden, skal man kontakte iGuzzini.

**N N.B.:** For informasjon om skifte av LED, vennligst ta kontakt med iGuzzini.

**S OBS!** För byte av lysdioden, kontakta företaget iGuzzini.

**RUS ПРИМЕЧАНИЕ:**Для замены СИДов обращайтесь в компанию iGuzzini.

**CN 注意:** 如需LED更换的信息, 请联系iGuzzini.

**I** Gruppo di rischio 1, secondo norma **EN 62471: 2008**  
**GB** Risk Group: 1, in compliance with Standard **EN 62471: 2008**  
**FR** Groupe de risque 1, suivant la norme **EN 62471 : 2008**  
**DE** Risikogruppe 1, gemäß Vorschrift **EN 62471: 2008**  
**NL** Risicogroep 1, volgens de norm **EN 62471: 2008**  
**E** Grupo de riesgo 1, según norma **EN 62471: 2008**  
**DK** Faregruppe 1 i henhold til standarden **EN 62471: 2008**  
**N** Risikogruppe 1, i henhold til forskriften **EN 62471: 2008**  
**S** Riskgrupp 1, enligt standard **EN 62471: 2008**  
**RUS** GROUP РИСК 1 В СООТВЕТСТВИИ СО **EN 62471: 2008**

**CN** 风险组:1  
灯具和灯具系统的光生物学安全性符合标准 **EN 62471: 2008**

**iGuzzini**

1.154.544.00

IS00766/05

**SOSTITUZIONE DEL LED**  
**REPLACING THE LED**  
**REPLACEMENT DE LA LED**  
**AUSTAUSCHEN DER LED**  
**VERVANGEN VAN DE LED**  
**REEMPLAZO DEL LED**  
**UDSKIFTNING AF LYSDIODE**  
**BYTE AV LYSDIOD**  
**UTSKIFTING AV DEN LYSEMITTERENDE DIODEN**  
**ЗАМЕНА СИДа**  
**发光二极管替换**

**I N.B.:** Per la sostituzione del LED contattare l'azienda iGuzzini.

**GB N.B.:** For information on LED replacement please contact iGuzzini.

**F N.B.:** Pour procéder au remplacement de la LED, adressez-vous à la société iGuzzini.

**D N.B.:** Bezüglich des Austausches der LED kontaktieren Sie bitte die Firma iGuzzini.

**NL N.B.:** Voor het vervangen van de LED neemt u contact op met het bedrijf iGuzzini.

**E NOTA:** Para sustituir el LED llame a la empresa iGuzzini.

**DK N.B.:** For udskiftning af lysdioden, skal man kontakte iGuzzini.

**N N.B.:** For informasjon om skifte av LED, vennligst ta kontakt med iGuzzini.

**S OBS!** För byte av lysdioden, kontakta företaget iGuzzini.

**RUS ПРИМЕЧАНИЕ:**Для замены СИДов обращайтесь в компанию iGuzzini.

**CN 注意:** 如需LED更换的信息, 请联系iGuzzini.

**I** Gruppo di rischio 1, secondo norma **EN 62471: 2008**  
**GB** Risk Group: 1, in compliance with Standard **EN 62471: 2008**  
**FR** Groupe de risque 1, suivant la norme **EN 62471 : 2008**  
**DE** Risikogruppe 1, gemäß Vorschrift **EN 62471: 2008**  
**NL** Risicogroep 1, volgens de norm **EN 62471: 2008**  
**E** Grupo de riesgo 1, según norma **EN 62471: 2008**  
**DK** Faregruppe 1 i henhold til standarden **EN 62471: 2008**  
**N** Risikogruppe 1, i henhold til forskriften **EN 62471: 2008**  
**S** Riskgrupp 1, enligt standard **EN 62471: 2008**  
**RUS** GROUP РИСК 1 В СООТВЕТСТВИИ СО **EN 62471: 2008**

**CN** 风险组:1  
灯具和灯具系统的光生物学安全性符合标准 **EN 62471: 2008**

**iGuzzini**



I PERIODO GIORNALIERO DI ACCENSIONE AMMESSO  
GB ALLOWED DAILY OPERATION PERIOD  
F DURÉE QUOTIDIENNE D'ALLUMAGE ADMISSIBLE  
D ERLAUBTE TÄGLICHE EINSCHALTDAUER  
NL DAGELIJKSE ONTSTEKINGSPERIODE TOEGESTAAN  
E PERIODO DIARIO DE ENCENDIDO PERMITIDO  
DK TILLADT TIDSRUM FOR DAGLIG TÆNDING  
N TILLATT TENNINGSTID PR. DAG  
S TILLÅTEN DAGLIG PERIOD SOM PRODUKTEN KAN VARA TÄND  
RUS ЕЖЕДНЕВНАЯ ДОПУСТИМАЯ ПРОДОЛЖИТЕЛЬНОСТЬ РАБОТЫ  
CN 允许的日常运营周期

iGuzzini

1.154.627.01  
IS09175/01



I PERIODO GIORNALIERO DI ACCENSIONE AMMESSO  
GB ALLOWED DAILY OPERATION PERIOD  
F DURÉE QUOTIDIENNE D'ALLUMAGE ADMISSIBLE  
D ERLAUBTE TÄGLICHE EINSCHALTDAUER  
NL DAGELIJKSE ONTSTEKINGSPERIODE TOEGESTAAN  
E PERIODO DIARIO DE ENCENDIDO PERMITIDO  
DK TILLADT TIDSRUM FOR DAGLIG TÆNDING  
N TILLATT TENNINGSTID PR. DAG  
S TILLÅTEN DAGLIG PERIOD SOM PRODUKTEN KAN VARA TÄND  
RUS ЕЖЕДНЕВНАЯ ДОПУСТИМАЯ ПРОДОЛЖИТЕЛЬНОСТЬ РАБОТЫ  
CN 允许的日常运营周期

iGuzzini

1.154.627.01  
IS09175/01

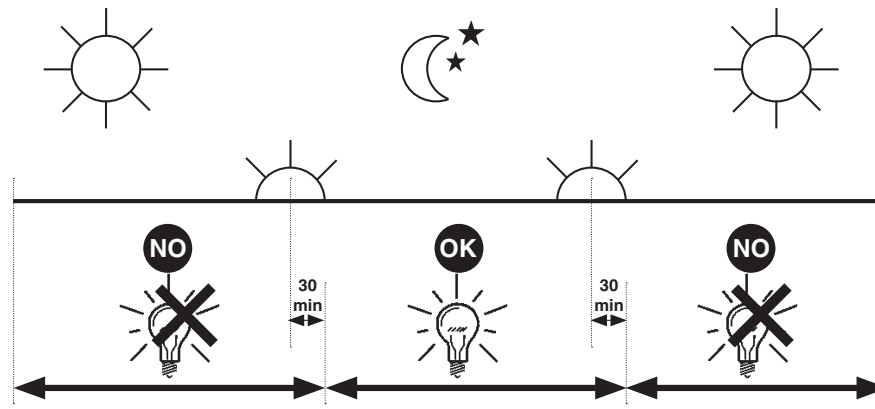

I PERIODO GIORNALIERO DI ACCENSIONE AMMESSO  
GB ALLOWED DAILY OPERATION PERIOD  
F DURÉE QUOTIDIENNE D'ALLUMAGE ADMISSIBLE  
D ERLAUBTE TÄGLICHE EINSCHALTDAUER  
NL DAGELIJKSE ONTSTEKINGSPERIODE TOEGESTAAN  
E PERIODO DIARIO DE ENCENDIDO PERMITIDO  
DK TILLADT TIDSRUM FOR DAGLIG TÆNDING  
N TILLATT TENNINGSTID PR. DAG  
S TILLÅTEN DAGLIG PERIOD SOM PRODUKTEN KAN VARA TÄND  
RUS ЕЖЕДНЕВНАЯ ДОПУСТИМАЯ ПРОДОЛЖИТЕЛЬНОСТЬ РАБОТЫ  
CN 允许的日常运营周期

iGuzzini

1.154.627.01  
IS09175/01



I PERIODO GIORNALIERO DI ACCENSIONE AMMESSO  
GB ALLOWED DAILY OPERATION PERIOD  
F DURÉE QUOTIDIENNE D'ALLUMAGE ADMISSIBLE  
D ERLAUBTE TÄGLICHE EINSCHALTDAUER  
NL DAGELIJKSE ONTSTEKINGSPERIODE TOEGESTAAN  
E PERIODO DIARIO DE ENCENDIDO PERMITIDO  
DK TILLADT TIDSRUM FOR DAGLIG TÆNDING  
N TILLATT TENNINGSTID PR. DAG  
S TILLÅTEN DAGLIG PERIOD SOM PRODUKTEN KAN VARA TÄND  
RUS ЕЖЕДНЕВНАЯ ДОПУСТИМАЯ ПРОДОЛЖИТЕЛЬНОСТЬ РАБОТЫ  
CN 允许的日常运营周期

iGuzzini

1.154.627.01  
IS09175/01

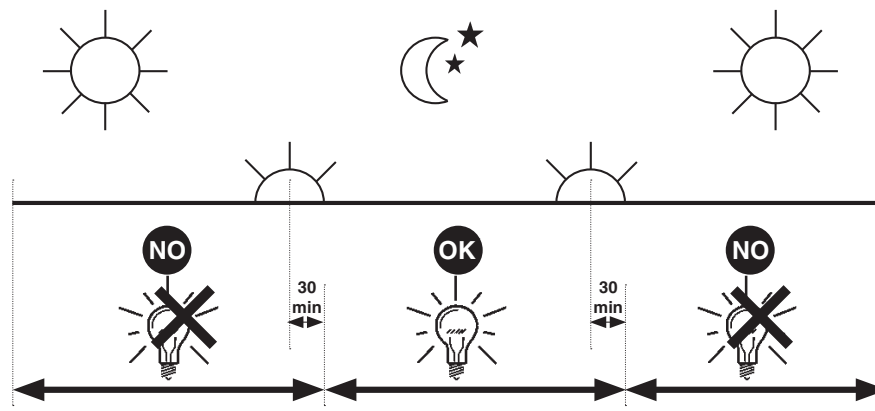

iGuzzini

2.509.386.00  
ISO9176/01

الفترة الزمنية اليومية للتشغيل المسموح بها

- I PERIODO GIORNALIERO DI ACCENSIONE AMMESSO
- GB ALLOWED DAILY OPERATION PERIOD
- E PERIODO DIARIO DE ENCENDIDO PERMITIDO



iGuzzini

2.509.386.00  
ISO9176/01

الفترة الزمنية اليومية للتشغيل المسموح بها

- I PERIODO GIORNALIERO DI ACCENSIONE AMMESSO
- GB ALLOWED DAILY OPERATION PERIOD
- E PERIODO DIARIO DE ENCENDIDO PERMITIDO

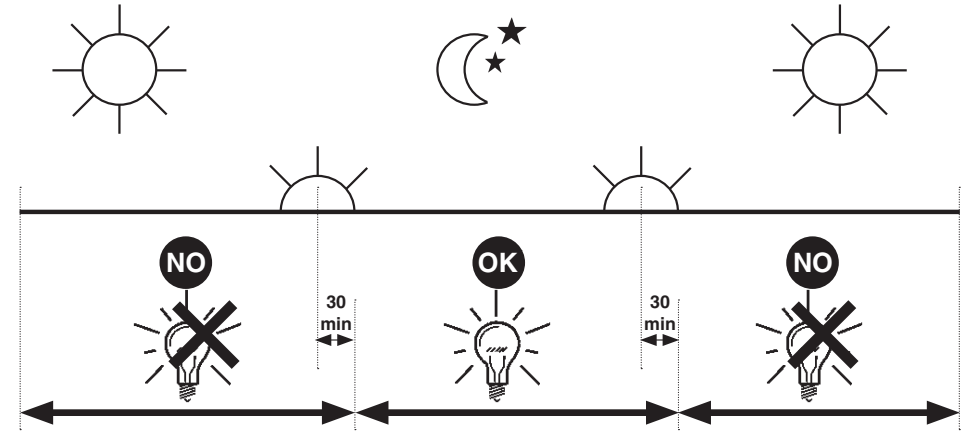

iGuzzini

2.509.386.00  
ISO9176/01

الفترة الزمنية اليومية للتشغيل المسموح بها

- I PERIODO GIORNALIERO DI ACCENSIONE AMMESSO
- GB ALLOWED DAILY OPERATION PERIOD
- E PERIODO DIARIO DE ENCENDIDO PERMITIDO

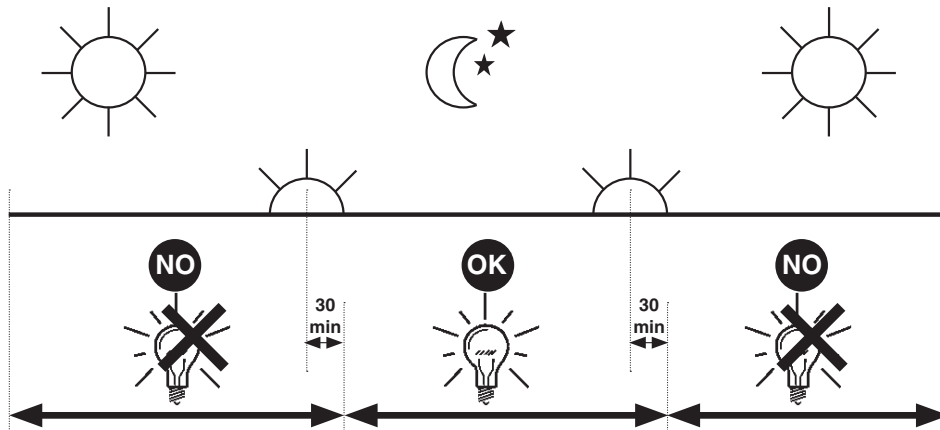

iGuzzini

2.509.386.00  
ISO9176/01

الفترة الزمنية اليومية للتشغيل المسموح بها

- I PERIODO GIORNALIERO DI ACCENSIONE AMMESSO
- GB ALLOWED DAILY OPERATION PERIOD
- E PERIODO DIARIO DE ENCENDIDO PERMITIDO

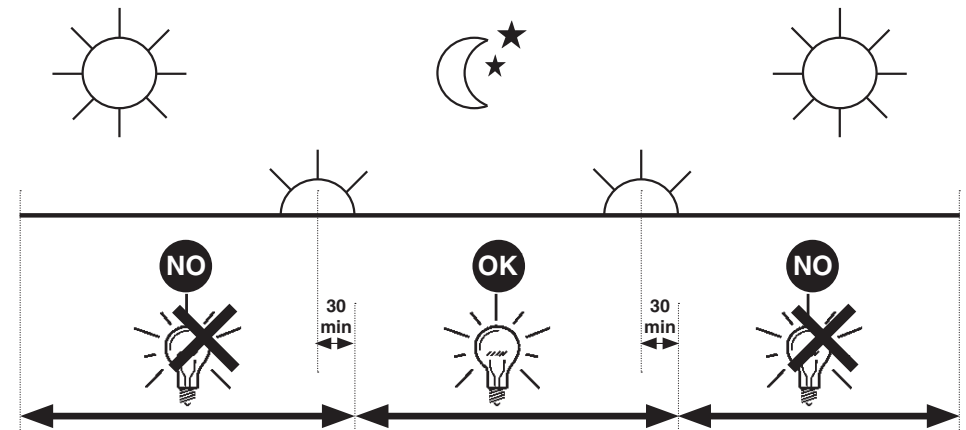

2.509.216.00  
IS05718/01

استبدال الضوء LED  
SOSTITUZIONE DEL LED  
REPLACING THE LED  
REEMPLAZO DEL LED

تنبیه: لاستبدال الضوء LED اتصل بشركة iGuzzini . عر

I N.B.: Per la sostituzione del LED contattare l'azienda iGuzzini.

GB N.B.: For information on LED replacement please contact iGuzzini.

E NOTA: Para sustituir el LED llame a la empresa iGuzzini.

عر فئة الخطر 1 . حسب مقاييس EN 62471: 2008 .

I Gruppo di rischio 1, secondo norma EN 62471: 2008

GB Risk Group: 1, in compliance with Standard EN 62471: 2008

E Grupo de riesgo 1, según norma EN 62471: 2008

iGuzzini

2.509.216.00  
IS05718/01

استبدال الضوء LED  
SOSTITUZIONE DEL LED  
REPLACING THE LED  
REEMPLAZO DEL LED

تنبیه: لاستبدال الضوء LED اتصل بشركة iGuzzini . عر

I N.B.: Per la sostituzione del LED contattare l'azienda iGuzzini.

GB N.B.: For information on LED replacement please contact iGuzzini.

E NOTA: Para sustituir el LED llame a la empresa iGuzzini.

عر فئة الخطر 1 . حسب مقاييس EN 62471: 2008 .

I Gruppo di rischio 1, secondo norma EN 62471: 2008

GB Risk Group: 1, in compliance with Standard EN 62471: 2008

E Grupo de riesgo 1, según norma EN 62471: 2008

iGuzzini

2.509.216.00  
IS05718/01

استبدال الضوء LED  
SOSTITUZIONE DEL LED  
REPLACING THE LED  
REEMPLAZO DEL LED

تنبیه: لاستبدال الضوء LED اتصل بشركة iGuzzini . عر

I N.B.: Per la sostituzione del LED contattare l'azienda iGuzzini.

GB N.B.: For information on LED replacement please contact iGuzzini.

E NOTA: Para sustituir el LED llame a la empresa iGuzzini.

عر فئة الخطر 1 . حسب مقاييس EN 62471: 2008 .

I Gruppo di rischio 1, secondo norma EN 62471: 2008

GB Risk Group: 1, in compliance with Standard EN 62471: 2008

E Grupo de riesgo 1, según norma EN 62471: 2008

iGuzzini

2.509.216.00  
IS05718/01

استبدال الضوء LED  
SOSTITUZIONE DEL LED  
REPLACING THE LED  
REEMPLAZO DEL LED

تنبیه: لاستبدال الضوء LED اتصل بشركة iGuzzini . عر

I N.B.: Per la sostituzione del LED contattare l'azienda iGuzzini.

GB N.B.: For information on LED replacement please contact iGuzzini.

E NOTA: Para sustituir el LED llame a la empresa iGuzzini.

عر فئة الخطر 1 . حسب مقاييس EN 62471: 2008 .

I Gruppo di rischio 1, secondo norma EN 62471: 2008

GB Risk Group: 1, in compliance with Standard EN 62471: 2008

E Grupo de riesgo 1, según norma EN 62471: 2008

iGuzzini

2.509.216.00  
IS05718/01

استبدال الضوء LED  
SOSTITUZIONE DEL LED  
REPLACING THE LED  
REEMPLAZO DEL LED

تنبیه: لاستبدال الضوء LED اتصل بشركة iGuzzini . عر

I N.B.: Per la sostituzione del LED contattare l'azienda iGuzzini.

GB N.B.: For information on LED replacement please contact iGuzzini.

E NOTA: Para sustituir el LED llame a la empresa iGuzzini.

عر فئة الخطر 1 . حسب مقاييس EN 62471: 2008 .

I Gruppo di rischio 1, secondo norma EN 62471: 2008

GB Risk Group: 1, in compliance with Standard EN 62471: 2008

E Grupo de riesgo 1, según norma EN 62471: 2008

iGuzzini

- I Istruzioni per le operazioni di servizio per l'apparecchio di illuminazione**  
**GB Instructions on luminaire service operations**  
**F Instructions pour les opérations de service du luminaire**  
**D Wartungsanleitung für die Leuchte**  
**NL Instructies voor de onderhoudsoperaties op de verlichtingsarmatuur**  
**E Instrucciones para las operaciones de servicio del aparato de alumbrado**  
**DK Anvisninger i serviceindgreb på belysningsarmatur**  
**N Anvisninger for betjening av lysapparatet**  
**S Instruktioner för användning av belysningsanordningen**  
**RUS Инструкции по эксплуатации осветительного прибора**  
**CN 照明装置检修操作说明**

**Sostituire la lampada parzialmente esausta**  
 Replace the partly exhausted lamp  
 Remplacer la lampe partiellement épuisée  
 Die teilweise erschöpfte Lampe austauschen  
 Vervang de gedeeltelijk lege lamp  
 Sustituir la lámpara parzialmente agotada  
 Udskift den delvist udtjente pære  
 Skifte ut den delvis utbrente lyspæren  
 Byt ut den delvis förbrukade lampan  
 Замена частично отработанной лампочки  
 更换部分老化的灯泡



**Spegnimento**  
 Switch it off  
 Extinction  
 Ausschaltung  
 Uitschakeling  
 Apagado  
 Slukning  
 Slukking  
 Släckning  
 Выключение  
 关灯

**Interrompere l'alimentazione dell'apparecchio**  
 Cut the power supply to the luminaire  
 Couper l'alimentation du luminaire  
 Stromversorgung der Leuchte unterbrechen  
 Onderbreek de voeding van het apparaat  
 Interrumpir la alimentación del aparato  
 Afbryd armaturets strømforsyning  
 Avbryt strømtilførselen til apparatet  
 Koppla från anordningens strömförsörjning  
 Отключить электропитание прибора  
 中断装置供电

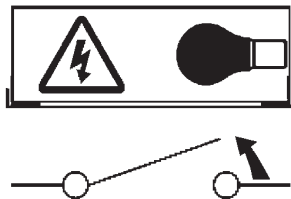

**Aprire l'apparecchio**  
 Open the fixture  
 Ouvrir le luminaire  
 Das Gerät öffnen  
 Open het apparaat  
 Abrir el aparato  
 Åbn armaturet  
 Åpne apparatet  
 Öppna anordningen  
 Раскрыть прибор  
 打开装置

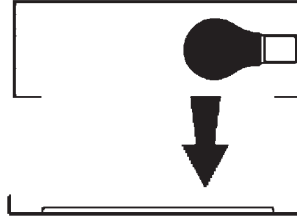

**Rimuovere la lampada esausta**  
 Remove the exhausted lamp  
 Retirer la lampe épuisée  
 Die alte Lampe entnehmen  
 Verwijder de lege lamp  
 Quitar la lámpara agotada  
 Tag den udtjente pære ud  
 Fjerne den utbrente lyspæren  
 Ta bort den förbrukade lampan  
 Вынуть старую лампочку  
 取出老化的灯泡

**Portarla in un centro di riciclaggio**  
 Carry it to a recycling centre  
 La porter dans une déchetterie pour son recyclage  
 Ordnungsgemäß entsorgen  
 Breng de lamp naar een recyclingcentrum  
 Llevarla a un centro de reciclaje  
 Aflever den på en genbrugsstation  
 Lever den til en miljøstasjon  
 Lämna in den till en återvinningsanläggning  
 Сдать ее в пункт приема утильсырья  
 将其送往回收中心

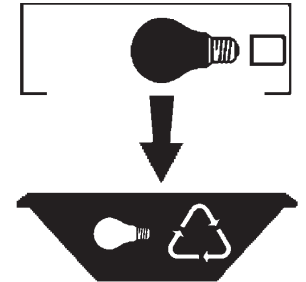

**Inserire la nuova lampada**  
 Introduce the new lamp  
 Installer la lampe neuve  
 Die neue Lampe einsetzen  
 Doe de nieuwe lamp op zijn plek  
 Montar la nueva lámpara  
 Sæt den nye pære i  
 Sette i den nye pæren  
 Sätt i den nya lampan  
 Вставить новую лампочку  
 装入新灯泡

**Inserire la nuova lampada nel portalampana**  
 Fit the new lamp into the socket  
 Installer la nouvelle lampe dans le support de lampe  
 Die neue Lampe in den Sockel einsetzen  
 Doe de nieuwe lamp in de lamphouder  
 Montar la nueva lámpara en el portalampana  
 Sæt den nye pære i fatningen  
 Sette den nye pæren inn i lampeholderen  
 Sätt i den nya lampan i lamphållaren  
 Вставить новую лампочку в патрон  
 将新灯泡插入灯泡架中

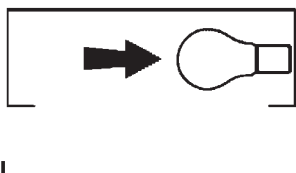

**Riposizionare ottica**  
 Re-place the optic  
 Remettre l'optique à sa place  
 Die Optik wieder einsetzen  
 Doe de optiek weer op zijn plaats  
 Volver a montar la óptica  
 Sæt den optiske enhed på plads  
 Innstille linsen  
 Flytta om optiken  
 Отрегулировать линзы  
 重新定位光头



**Effettuare prova di funzionamento**  
 Perform operative test  
 Procéder à un essai de fonctionnement  
 Eine Funktionsprüfung durchführen  
 Controleer de correcte werking  
 Hacer una prueba de funcionamiento  
 Afprøv funktionen  
 Prøve om den fungerer  
 Utför funktionstest  
 Выполнить проверку исправности работы  
 执行功能测试



**I Istruzioni per la pulizia dell'apparecchio di illuminazione**  
**GB Instructions on luminaire cleaning operations**  
**F Instructions pour le nettoyage du luminaire**  
**D Anweisungen zur Reinigung der Leuchte**  
**NL Instructies voor de reiniging van de verlichtingsarmatuur**  
**E Instrucciones para limpiar el aparato de alumbrado**  
**DK Anvisninger i rengøring af belysningsarmaturet**  
**N Anvisninger for rengjøring av lysapparatet**  
**S Instruktioner för rengöring av belysningsanordningen**  
**RUS Инструкции по чистке осветительного прибора**  
**CN 照明装置清洁说明**

**Pulire l'apparecchio**  
**Clean the fixture**  
**Nettoyer le luminaire**  
**Das Gerät reinigen**  
**Reinig het apparaat**  
**Limpiar el aparato**  
**Rengør armaturet**  
**Rengjøre apparatet**  
**Rengör anordningen**  
**Чистка прибора**  
**清洁装置**

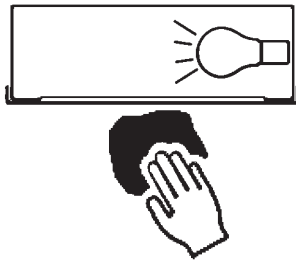

**Spegnimento**  
**Switch it off**  
**Extinction**  
**Ausschaltung**  
**Uitschakeling**  
**Apagado**  
**Slukning**  
**Slukking**  
**Släckning**  
**Выключение**  
**关灯**

**Interrompere l'alimentazione dell'apparecchio**  
**Cut the power supply to the luminaire**  
**Couper l'alimentation du luminaire**  
**Stromversorgung der Leuchte unterbrechen**  
**Onderbreek de voeding van het apparaat**  
**Interrumpir la alimentación del aparato**  
**Afbryd armaturets strømforstyrning**  
**Avbryt strømtilførselen til apparatet**  
**Koppla från anordningens strömförsörjning**  
**Отключить электропитание прибора**  
**中断装置供电**



**Spolverare l'ottica esterna**  
**Remove dust from the external optic**  
**Dépoussiérer l'optique extérieure**  
**Die externe Optik abstauben**  
**Stof de externe optiek af**  
**Quitar el polvo de la óptica exterior**  
**Tør støvet af den udvendige optiske enhed**  
**Fjerne støv fra den eksterne lysenheten**  
**Damma av den yttre optiken**  
**Вытереть пыль с внешней стороны линз**  
**为外侧光头掸尘**

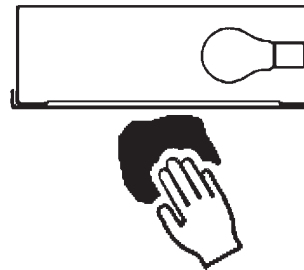

**Lavare l'ottica esterna**  
**Wash the external optic**  
**Laver l'optique extérieure**  
**Die externe Optik waschen**  
**Was de externe optiek**  
**Lavar la óptica exterior**  
**Vask den udvendige optiske enhed**  
**Vaske den eksterne lysenheten**  
**Rengör den yttre optiken**  
**Вымыть линзы с внешней стороны**  
**清洁外光头**



**Rimuovere l'ottica**  
**Remove the optic**  
**Retirer l'optique**  
**Die Optik abnehmen**  
**Verwijder de optiek**  
**Quitar la óptica**  
**Tag den optiske enhed af**  
**Fjerne lysenheten**  
**Ta bort optiken**  
**Снять линзы**  
**取下光头**

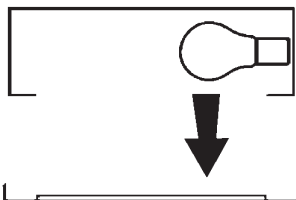

**Pulire la parte interna dell'apparecchio di illuminazione**  
**Clean the inside of the fixture**  
**Nettoyer l'intérieur du luminaire**  
**Die Innenseite der Leuchte reinigen**  
**Reinig de binnenzijde van de verlichtingsarmatuur**  
**Limpiar el interior del aparato de alumbrado**  
**Rengør belysningsarmaturets indvendige dele**  
**Rengjøre lysapparatet innvendig**  
**Rengör belysningsanordningen invändigt**  
**Протереть осветительный прибор изнутри**  
**清洁照明装置内部**



**Riposizionare ottica**  
**Re-place the optic**  
**Remettre l'optique à sa place**  
**Die Optik wieder einsetzen**  
**Doe de optiek weer op zijn plaats**  
**Volver a montar la óptica**  
**Sæt den optiske enhed på plads**  
**Innstille linsen**  
**Flytta om optiken**  
**Отрегулировать линзы**  
**重新定位光头**



**Effettuare prova di funzionamento**  
**Perform operative test**  
**Procéder à un essai de fonctionnement**  
**Eine Funktionsprüfung durchführen**  
**Controleer de correcte werking**  
**Hacer una prueba de funcionamiento**  
**Afprøv funktionen**  
**Prøve om den fungerer**  
**Utför funktionstest**  
**Выполнить проверку исправности работы**  
**执行功能测试**

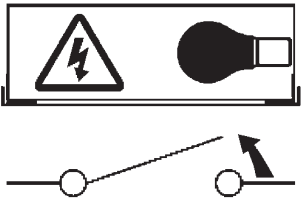
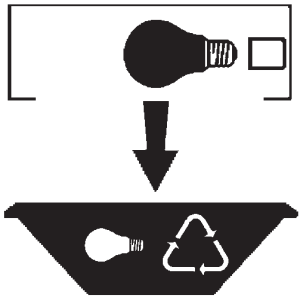
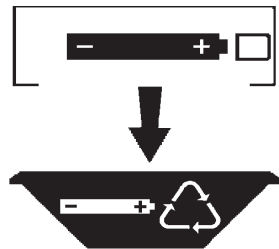
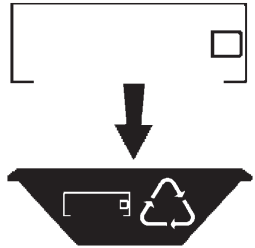

- I Istruzioni per il fine vita e lo smaltimento dei componenti**  
**GB Instructions on end-of-life and component disposal**  
**F Instructions pour la gestion des composants en fin de vie et leur mise au rebut**  
**D Anweisungen zur Entsorgung der Leuchtenkomponenten**  
**NL Instructies voor het verwijderen van de armatuur en het recyclen van de onderdelen**  
**E Instrucciones para el final de vida y la eliminación los componentes**  
**DK Anvisninger i udtjent armatur og bortskaffelse af komponenter**  
**N Anvisninger for endt levetid og avfallsbehandling av delene**  
**S Instruktionser vid bortskaffning och kassering av komponenter**  
**RUS Инструкции по утилизации прибора и его комплектующих по окончании его срока службы**  
**CN 寿命期结束与零件废弃处置说明**

<p><b>Spegnimento</b> Switch it off Extinction Ausschaltung Uitschakeling Apagado Slukning Slukking Släckning Выключение 关灯</p> <p>Interrompere l'alimentazione dell'apparecchio Cut the power supply to the luminaire Couper l'alimentation du luminaire Stromversorgung der Leuchte unterbrechen Onderbreek de voeding van het apparaat Interrompirla alimentación del aparato Afbryd armaturets strømforsyning Avbryt strømtilførselen til apparatet Koppla från anordningens strömförsörjning Отключить электропитание прибора 中断装置供电</p> 	<p><b>Rimuovere la/lampada/e per la dismissione</b> Remove the lamp(s) for decommissioning Retirer la(les) lampe(s) pour sa(leur) mise au rebut Die Lampe/n ordnungsgemäß entsorgen Verwijder de lamp(en) voor het recyclen Quitar la(s) lámpara(s) para el desecho Tag pæren/pærerne ud til bortskaffelse Fjerne lampen/-e som skal kastes Ta bort lampan/-orna för bortskaffningen Вынуть лампочку/и для утилизации прибора 取出需要丢弃的灯泡</p> 	<p><b>Rimuovere la batteria per la dismissione</b> Remove the battery for decommissioning Retirer la batterie pour sa mise au rebut Die Batterie ordnungsgemäß entsorgen Verwijder de batterij voor het recyclen Quitar la batería para el desecho Tag batteriet ud til bortskaffelse Fjerne batteriet som skal kastes Ta bort batteriet för bortskaffningen Вынуть батарейку для утилизации прибора 取出需要丢弃的电池</p> 	<p><b>Rimuovere l'apparecchio per la dismissione</b> Remove the fixture for decommissioning Enlever le luminaire pour sa mise au rebut Das Gerät ordnungsgemäß entsorgen Verwijder het apparaat voor het recyclen Quitar el aparato para el desecho Tag armaturet ud til bortskaffelse Fjerne apparatet som skal kastes Ta bort anordningen för bortskaffningen Снять прибор для утилизации 取出需要丢弃的装置</p> 
--	---	---	---

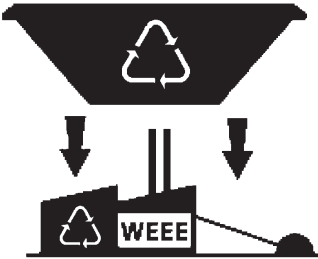
<p><b>Inviare i materiali ad un centro di raccolta RAEE</b> Send the materials to a WEEE collection centre Envoyer les matériaux dans une déchetterie DEEE Die Materialien in einem WEEE-Zentrum entsorgen Zend de materialen naar een recyclingscentrum voor de AEEA Enviar los materiales a un centro de recogida RAEE Afløver materialerne på et indsamlingscenter for elektronisk udstyr Sende materialene til en miljøstasjon for resirkulering av EE-avfall Skicka materialet till en RAEE uppsamlingscentral Сдать материалы в пункт приема утильсырья 将材料送往电气和电子垃圾回收中心</p> 			
---	--	--	--