

## LEDPLUS

**I ATTENZIONE:**

LA SICUREZZA DELL'APPARECCHIO È GARANTITA SOLO CON L'USO APPROPRIATO DELLE SEGUENTI ISTRUZIONI; PERTANTO È NECESSARIO CONSERVARLE.

**GB WARNING:**

THE SAFETY OF THIS FIXTURE IS GUARANTEED ONLY IF YOU COMPLY WITH THESE INSTRUCTIONS; REMEMBER TO CONSERVE IN A SAFE PLACE.

**F ATTENTION:**

LA SECURITE DE L'APPAREIL N'EST GARANTIE QU'EN CAS D'UTILISATION CORRECTE DES INSTRUCTIONS SUIVANTES; IL FAUT PAR CONSEQUENT LES CONSERVER.

**D ACHTUNG:**

DIE SICHERHEIT DES GERÄTES WIRD NUR DURCH SACHGEMÄSSE BEFOLGUNG NACHSTEHENDER ANWEISUNGEN GEWÄHRLEISTET; IHRE AUFBEWAHRUNG IST DESHALB SEHR WICHTIG.

**NL OPGELET:**

DE VEILIGHEID VAN DI ATOESTEL IS SLECHTS DAN GEGARANDEERD ALS INDIEN DE VOLGENDE INSTRUCITIES STRIKT WORDEN TOEGEPAST: DAAROM MOET MEN ZE OOK BEWAREN.

**E ATENCION:**

LA SEGURIDAD DEL APARATO SE GARANTIZA SOLO CUMPLIENDO CUIDADOSAMENTE LAS SIGUIENTES INSTRUCCIONES; POR ELLO, ES NECESARIO CONSERVARLAS.

**DK BEMÆRK:**

SIKKERHEDEN VED BRUG AF ARMATURET KAN KUN GARANTERES, HVIS DISSE ANVISNINGER FØLGES; SØRG DERFOR FOR AT GEMME DEM.

**N ADVARSEL:**

SIKKERHETEN TIL DETTE APPARATET GARANTERES KUN HVIS DU OVERHOLDER DISSE INSTRUKSJONENE; HUSK Å OPPBEVARE DEM PÅ ET TRYGT STED.

**S OBSERVERA!**

UTRUSTNINGENS SÄKERHET KAN ENDAST GARANTERAS OM DESSA ANVISNINGAR RESPEKTERAS I DETALJ. SPARA DÄRFÖR DESSA ANVISNINGAR FÖR FRAMTIDA KONSULTATION.

**RUS ВНИМАНИЕ:**

МЫ ГАРАНТИРУЕМ БЕЗОПАСНУЮ ЭКСПЛУАТАЦИЮ ИЗДЕЛИЯ ТОЛЬКО ПРИ СОБЛЮДЕНИИ СЛЕДУЮЩИХ ИНСТРУКЦИЙ; С ЭТОЙ ЦЕЛЬЮ НЕОБХОДИМО СОХРАНИТЬ ДАННУЮ БРОШЮРУ.

**CN 警告**

为确保该装置安全，请遵守操作指示，并于安全场所放置。

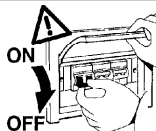

I N.B.: L'apparecchio non deve, in alcuna circostanza, essere coperto con materiale isolante o similare.

GB N.B.: The fixture must not be covered, under any circumstances, by insulating materials or the like.

F N.B.: L'appareil ne doit, en aucun cas, être couvert par un matériau isolant ou autre.

D N.B.: Das Gerät darf auf keinen Fall mit Isoliermaterial oder ähnlichem bedeckt werden.

NL N.B.: Het apparaat mag in geen geval bedekt worden met isoleringsmateriaal of dergelijke.

E NOTA: El aparato no debe ser protegido con material aislante o parecido, por ninguna causa.

DK N.B.: Armaturet må under ingen omstændigheder tildækkes med isolerende materiale eller lignende materiale.

N N.B.: Armaturen må ikke under noen omstendigheter tildekkes med isolerende materialer eller lignende.

S OBS! Utrustningen får inte under några omständigheter täckas över med isolerande material eller liknande.

RUS ПРИМЕЧАНИЕ: Категорически запрещается покрывать прибор изоляционным или подобным материалом.

CN 不管什么情况下灯具都不能被隔热衬垫或类似材料盖住



I Per la disposizione dei tubi corrugati e/o dei cavi elettrici, fare riferimento al progetto dell'impianto.

GB See the system project for the arrangement of the corrugated pipes and/or electric cables.

F Pour la disposition des conduits annelés et/ou des câbles électriques, veuillez vous reporter au projet de l'installation.

D Zur Verlegung der flexiblen Leerrohre und/oder der Elektrokabel verweisen wir auf das Anlageprojekt.

NL Het rangschikken van de gegolfde buizen en/of de elektrische kabels moet u uitvoeren op basis van de gegevens die u in het ontwerp van het systeem terugvindt.

E Para la ubicación de los tubos corrugados y/o de los cables eléctricos, hágase referencia al proyecto de la instalación.

DK Se anlægsudformningen for placering af bølgerør og/eller elektriske ledninger.

N Se systemprosjektet for ordningen av korrugerte rør og/eller elektriske kabler.

S För dragningen av korrugerade rör och/eller elkablar hänvisas till systemets projekt.

RUS Расположение гофрированных труб и/или электропроводки смотрите в проекте системы.

CN 针对波纹管和/或电缆的排列，参见系统计划。

N.B.: DURANTE L'INSTALLAZIONE DEL SISTEMA "LED PLUS" RISPETTARE SCRUPOLOSAMENTE LE NORME IMPIANTISTICHE NAZIONALI VIGENTI.

N.B.: WHEN INSTALLING THE "LED PLUS" SYSTEM, MAKE SURE ALL CURRENT NATIONAL REGULATIONS RELATING TO INSTALLATION ARE OBSERVED.

N.B.: LORS DE L'INSTALLATION DU SYSTÈME "LED PLUS" VEUILLEZ RESPECTER RIGOREUSEMENT LES NORMES EN VIGUEUR EN LA MATIÈRE DANS LE PAYS.

N.B.: BEACHTEN SIE BEI DER INSTALLATION DES SYSTEMS "LED PLUS" UNBEDINGT DIE IM LAND GELTENDEN ANLAGETECHNISCHEN VORSCHRIFTEN.

N.B.: BIJ HET INSTALLEREN VAN HET "LED PLUS" SYSTEEM MOET U DE GELDENDE NATIONALE INSTALLATIENORMEN STRIKT NALEVEN.

NOTA: DURANTE LA INSTALACIÓN DEL SISTEMA "LED PLUS" RESPETAR ESCRUPULOSAMENTE LAS NORMAS NACIONALES DE INSTALACION EN VIGOR.

N.B.: UNDER INSTALLATION AF "LED PLUS" SYSTEMET SKAL MAN NØJE OVERHOLDE DE GÆLDENDE REGLER FOR DISSE ANLÆG.

N.B.: UNDER INSTALLASJON AV SYSTEMET "LED PLUS" MÅ DE NASJONALE ANLEGGSFORSKRIFTENE OVERHOLDES NØY.

OBS! UNDER INSTALLATIONEN AV SYSTEMET "LED PLUS" SKA GÄLLANDE NATIONELLA INSTALLATIONSFÖRESKRIFTER RESPEKTERAS I DETALJ.

ПРИМЕЧАНИЕ: В ПРОЦЕССЕ МОНТАЖА СИСТЕМЫ "LED PLUS" СТРОГО СОБЛЮДАЙТЕ НАЦИОНАЛЬНЫЕ ДЕЙСТВУЮЩИЕ НОРМАТИВЫ ПО ЭЛЕКТРОПРОВОДКЕ.

注意：安装"LED PLUS"系统时请务必遵守系统标准。

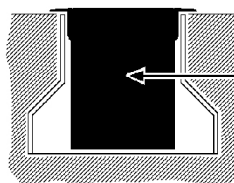

IP68 1m

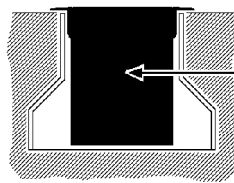

IP67

art. B318 - B319 - B320  
B321 - B322 - B336  
B337 - B338 - B339  
B340 - BB45 - BB46  
BB49 - BB50



10000/5000N



40°C

I Gli apparecchi sono stati progettati e collaudati per reggere un carico statico fino a 10000 N; la temperatura massima rilevata sul vetro è di 40°C. L'installazione è ammessa in zone pedonali, piste ciclabili o piscine.

GB The fittings were designed and tested to withstand a static load up to 10000 N. The maximum temperature measured on the glass is 40°C. The fittings can be installed on pedestrian areas, cycle lanes or swimming pools.

F Les appareils ont été spécialement conçus et testés pour supporter une charge statique pouvant atteindre 10000 N; la température maximale mesurée sur le verre est de 40°C. L'installation est autorisée dans les zones piétonnes, les pistes cyclables et les abords des piscines.

D Bei der Entwicklung und Prüfung der Leuchten wurde sichergestellt, dass sie einer statischen Belastung von bis zu 10000 N standhalten; die am Glas erfasste maximale Temperatur beträgt 40°C. Die Leuchten eignen sich zur Installation auf Gehwegen, Fahrradwegen oder Swimmingpools.

NL De apparaten zijn ontworpen en goedgekeurd om een statisch gewicht tot 10000 N te kunnen dragen; de maximumtemperatuur die op het glas is gemeten is 40°C. De installatie is toegestaan in voetgangerszones, fietspaden en zwembaden.

E Los aparatos han sido diseñados y ensayados para resistir una carga estática de 10000 N; la temperatura máxima medida en el cristal es de 40°C. La instalación está permitida en zonas peatonales, pistas de bicicletas o piscinas.

DK Armaturerne er udviklet og afprøvet til en statisk belastning på op til 10000 N. Maks. temperatur på glasset er 40°C og de er tilladt til installationer på fortove, på cykelstier eller swimmingpoolområder.

N Armaturene ble designet og testet for å motstå en statisk belastning på inntil 10000 N. Maksimal temperatur målt på glasset er 40°C. Armaturene kan installeres i gangområder, sykkelstier eller svømmebassenger.

S Utrustningen är konstruerad och testad för att tåla en statisk belastning på upp till 10000 N. Max. temperatur som har uppmätts på glasset är 40°C. Utrustningen kan installeras i områden med gågator eller cykelvägar.

RUS Устройства были разработаны и протестированы для работы при статической нагрузке до 10000 N; максимальная температура, измеренная на поверхности стекла, 40 °С. Используются для освещения пешеходных зон, велосипедных дорожек или бассейнов.

CN 此设备经设计和测试后能经受一个为10000 N的静载荷。玻璃上的最大测量温度为40°C。此设备可以安装在步行区域，自行车车道或者是游泳池

I N.B. Si consiglia di effettuare le operazioni d'installazione o di manutenzione all'interno del vano ottico, in ambienti interni o quanto meno in assenza di umidità o pioggia.

GB N.B.: Installation and maintenance operations must be carried out inside the optical assembly, indoor and in a place with no humidity or rain.

F N.B.: Pour effectuer les opérations d'installation ou d'entretien des composants intérieurs du bloc optique, il est conseillé de se rendre dans un espace clos, ou tout du moins à l'abri de l'humidité ou de la pluie.

D Hinweis: Es empfiehlt sich, alle Installations- oder Wartungseingriffe am Leuchtengehäuse in geschlossenen Räumen bzw. bei trockenen Luftverhältnissen vorzunehmen (Feuchtigkeit und Regen vermeiden).

NL N.B.: We raden u aan de installatie- of onderhoudshandelingen van de optische behuizing binnenshuis uit te voeren, of in ieder geval in een omgeving waar geen vocht of regen is.

N.B.: Se recomienda efectuar las operaciones de instalación o mantenimiento dentro del cuerpo óptico, en interiores o por lo menos en ausencia de humedad o lluvia.

N.B. Det anbefales at udføre installation eller vedligeholdelse inden i den optiske enhed indenfor på et område fri for fugt og regn.

N.B.: Det anbefales å utgjøre installasjons- eller vedlikeholdsinngrepene inne i det optiske rommet, innendørs eller i hvert fall der det ikke finnes fuktighet eller regn.

OBS! Det anbefales å utføre installasjons- eller underhållsinterveneringer i det optiske rommet i et lukket område eller i et område som er beskyttet mot fukt og regn.

RUS ПРИМЕЧАНИЕ: Рекомендуется выполнять монтаж или техническое обслуживание внутри lampового отсека в закрытых помещениях или по крайней мере в отсутствие влаги или атмосферных осадков.

CN 注释：建议在光学空间内部进行安装或者维修操作至少在内部环境或者不存在雨水或潮湿的环境。

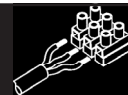
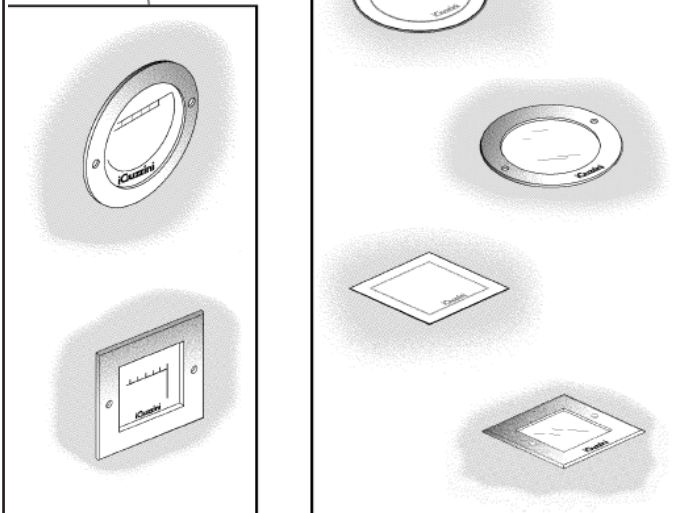
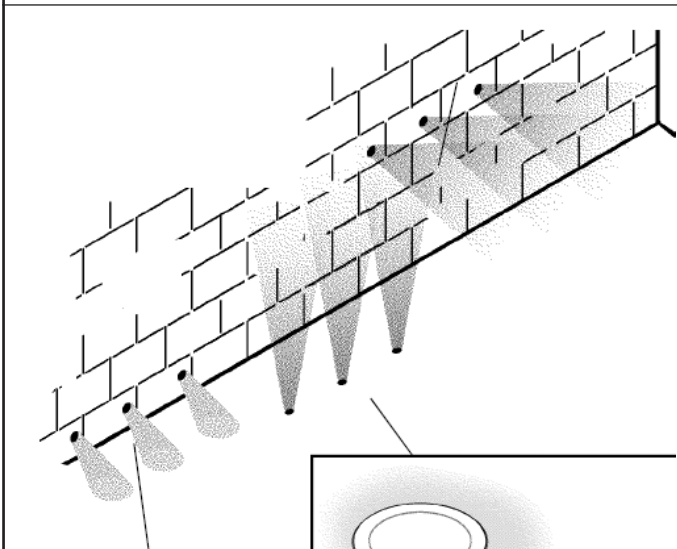
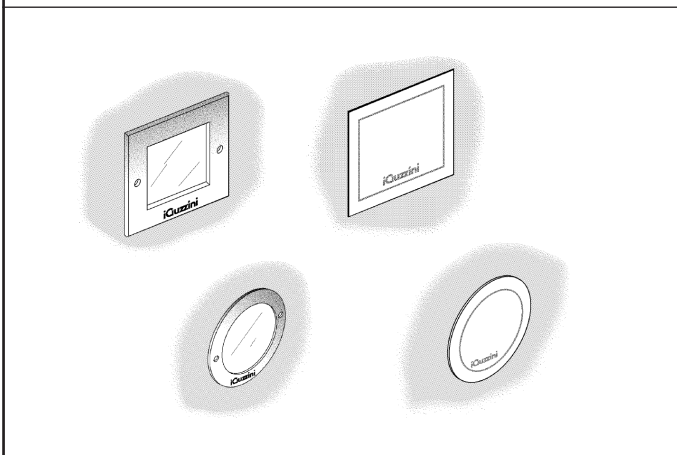

I Cablare alla rete elettrica il trasformatore solo dopo aver effettuato il collegamento ai prodotti

GB Wire the transformer to the electrical mains only after the connection to the products has been carried out

F N'effectuer le câblage au réseau électrique qu'après avoir effectué le raccordement aux produits

D Schließen Sie den Transformator erst nach der Verdrahtung an den Produkten am Stromnetz an.

E Cablear el transformador a la red eléctrica sólo después de conectar los productos

NL Verbind de transformator alleen op het elektrische net nadat u alle producten heeft aangesloten.

DK Tilslut først transformatoren til strømforsyningsnettet, efter at have foretaget tilslutningen til produkterne.

N Omformeren skal kun kobles til strømmettet etter at tilkoblingen til produktene er gjennomført.

S Anslut transformatorn till elnätet först efter att anslutningen till produkterna har utförts.

RUS Подвести кабель трансформатора к электрической сети, только после соединения с продуктами

CN 只有连接灯具后，才可以把变压器连接到电源线上。

I Si consiglia di proteggere adeguatamente il cavo dal contatto diretto con il terreno.

GB The cable should be suitably protected against direct contact with the ground.

F Nous conseillons de protéger adéquatement le câble du contact direct avec le sol.

D Es wird empfohlen, das Kabel ausreichend vor dem direkten Kontakt mit dem Erdreich zu schützen.

NL Geadviseerd wordt om de kabel adequaat te beschermen tegen direct contact met de grond.

E Se recomienda proteger adecuadamente el cable del contacto directo con el terreno.

DK Det anbefales at beskytte kablet på passende vis mod direkte kontakt med jorden.

N Vi anbefaler at kablen beskyttes tilstrekkelig fra kontakt med bakken.

S Det rekommenderas att skydda kablarna så att den inte är i direkt kontakt med marken.

RUS Рекомендуется защитить надлежащим образом кабель от прямого контакта с землей.

CN 建议采取适当的方式保护电缆，防止其与地面直接接触。

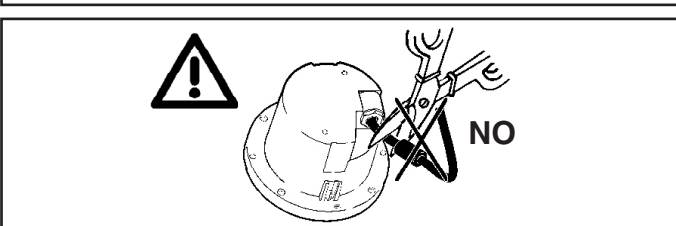
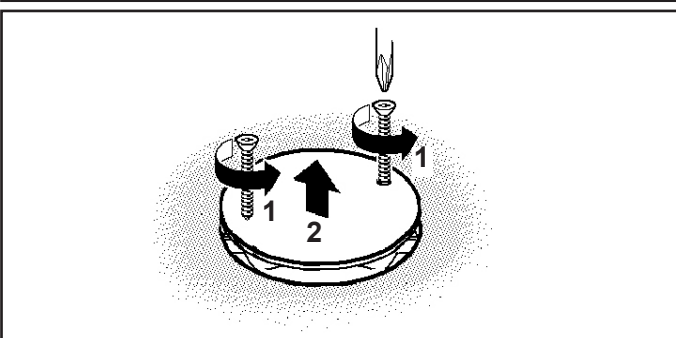

I In caso di danneggiamento del cavo elettrico con spina, la sostituzione deve essere effettuata dal costruttore, dal suo servizio di assistenza o da personale qualificato equivalente, al fine di evitare pericoli.

GB In the event of damage to the electric cable with plug, replacement must be carried out by the manufacturer, by the after-sales assistance of the same or by a qualified professional, in order to avoid all risk of danger.

F Si le câble électrique avec fiche est endommagé, faites-le remplacer par le fabricant, son service après-vente ou un professionnel du secteur, pour éviter tout risque de danger.

D Zur Vermeidung von Gefahren sind Elektrokabel und Stecker im Falle einer Beschädigung vom Hersteller, von dessen Kundendienst oder von spezialisiertem Fachpersonal auszuwechseln.

NL Mocht het elektrische snoer met stekker beschadigd raken, dan moet het vervangen ervan worden uitgevoerd door de fabrikant, zijn Technische Dienst of door een erkende installateur, teneinde gevaar te vermijden.

E En caso de daño del cable eléctrico con enchufe, la sustitución debe realizarse por el fabricante, su servicio de asistencia o bien personal especializado equivalente debido a razones de seguridad.

DK Hvis ledningen med stik beskadiges, skal den udskiftes af producenten eller et autoriseret teknisk servicecenter, eller af kvalificerede fagfolk, så man undgår farlige situationer.

N I tilfelle skade på den elektriske kablen med plugg, må erstatning utføres av produsenten, gjennom ettersalgavdelingen til denne eller av en kvalifisert fagperson, for å unngå all fare.

S Om elkabeln med stickkontakten skadas, ska den bytas ut av tillverkaren, av dess auktoriserade verkstad eller av likvärdig kvalificerad personal för att undvika alla typer av risker.

RUS В случае повреждения электрического кабеля со штепсельной вилкой во избежание риска поручите его замену производителю, уполномоченному сервису или квалифицированному электрику.

CN 如出现带插头电缆的损坏，须由生产商、售后服务助理或资深专业人员更换新的电缆，以避免任何可能的危险。

ALIMENTAZIONE  
POWER SUPPLY  
ALIMENTATION  
EINSPEISUNG  
VOEDING  
ALIMENTACIÓN  
STRØMFORSYNING  
STRØMTILFØRSEL  
ELFORSØRJNING  
ЭЛЕКТРОПИТАНИЕ  
能源

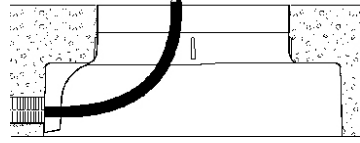
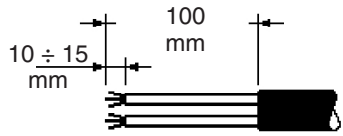

24V  $\equiv$   
220/240V  $\approx$

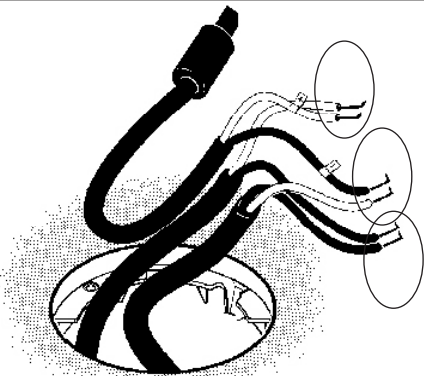
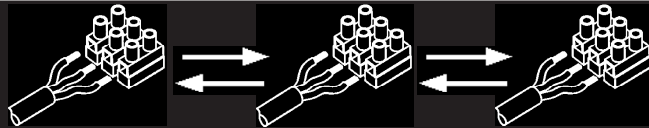
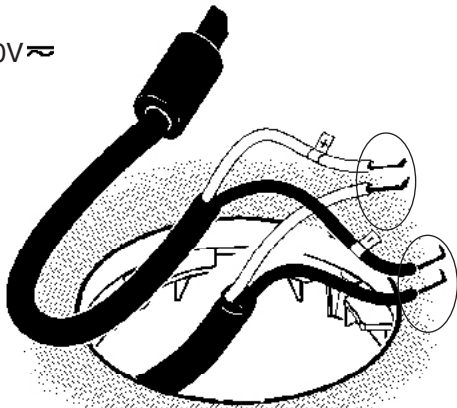

### EFFECT EQUALIZER

24V  $\equiv$   
220/240V  $\approx$

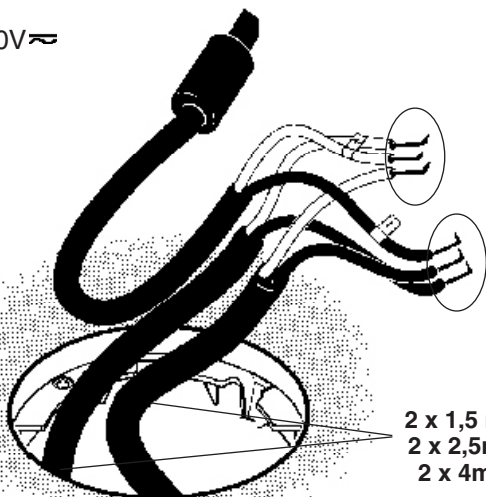

2 x 1,5 mm<sup>2</sup>  
2 x 2,5mm<sup>2</sup>  
2 x 4mm<sup>2</sup>

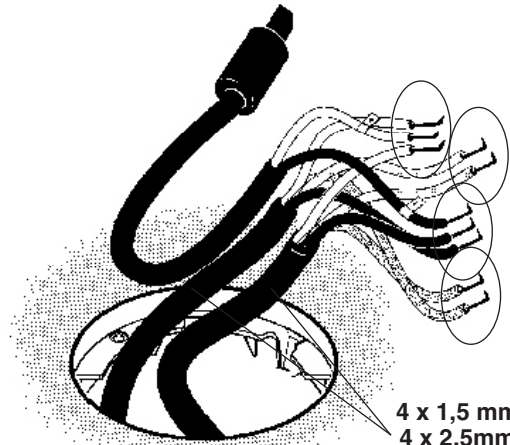

4 x 1,5 mm<sup>2</sup>  
4 x 2,5mm<sup>2</sup>  
4 x 4mm<sup>2</sup>

### COLOUR EQUALIZER

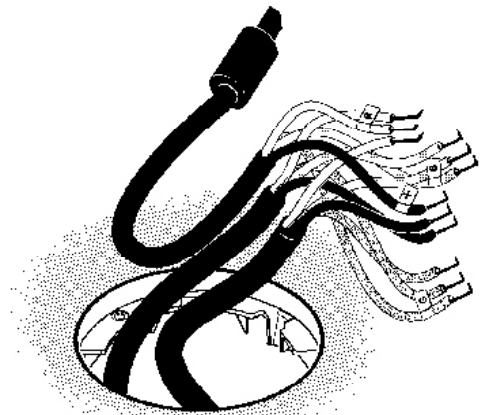

LOW VOLTAGE  $\equiv$  **A B C**  
220/240V  $\approx$  **C**



LOW VOLTAGE  $\equiv$  **B C**  
220/240V  $\approx$  **C**

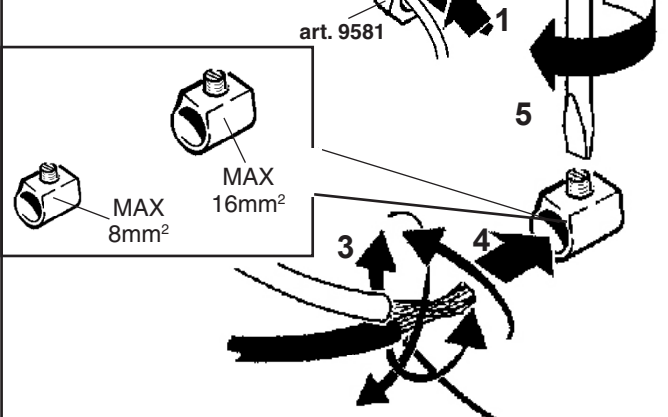
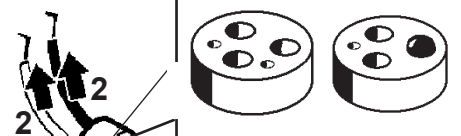
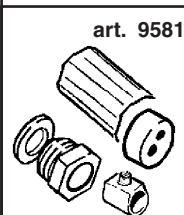

I N.B.: Verificare manualmente la tenuta dei cavi nel morsetto.  
 GB N.B.: Manually check the tightness of the cables in the terminal board.  
 F N.B.: Veuillez vérifier manuellement la tenue des fils dans la borne.  
 D NB: Der Halt der Drähte in der Klemme ist von Hand zu prüfen.  
 NL N.B.: Verifieer handmatig of de kabels goed in de klemmenstrook vastzitten.  
 E N.B.: Verificar manualmente la fijación de los cables en el terminal.  
 DK N.B.: Kontrollér, at ledningerne i klemmen sidder ordentligt fast.  
 N N.B.: Kontrollér tettheten til kablene i terminalkortet manuelt.  
 S OBS! Kontrollera för hand att kablarna sitter ordentligt fast i klämman.  
 RUS ПРИМЕЧАНИЕ: Проверьте вручную прочность соединения проводов к клеммам.  
 CN 注意: 手动检查接线排电缆的牢固性。

**A**

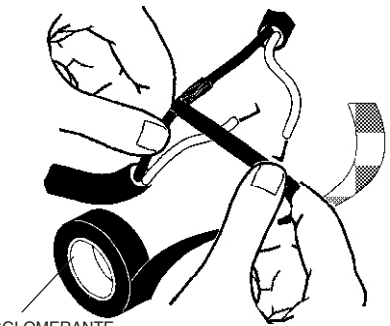

NASTRO AUTOAGGLOMERANTE  
 SELF-VULCANISING TAPE  
 RUBAN AUTO-SOUDABLE  
 SELBSTHAFTBAND - (Klebefilm SCOTCH 23 3M)  
 ZELFFUSERENDE TAPE  
 CINTA AUTOAGGLOMERANTE (SCOTCH 23 3M)  
 SELVKLÆBENDE BÅND  
 SELVVULKANISERENDE TAPE  
 SJÄLVBINDANDE BAND  
 САМОПЛАСТИФИЦИРУЮЩАЯСЯ ЛЕНТА  
 自硫化带

STAGNARE - COAT WITH TIN  
 TIN ETAMER - VERZINNEN  
 - VERTINNEN - ESTANAR - FORSEGLE - LÖD  
 ЛУЖЕНЫЕ 锡焊

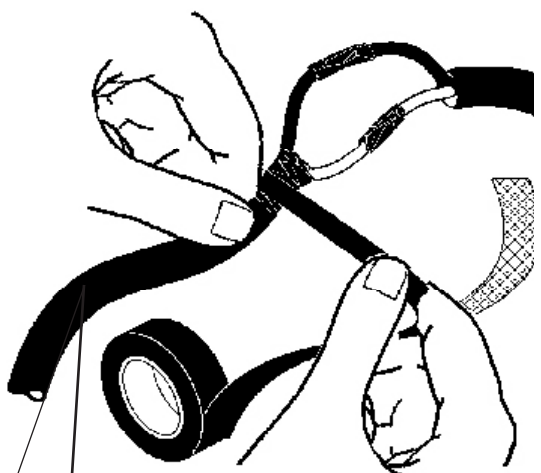
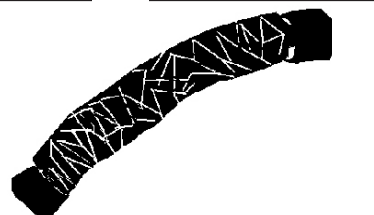
**B**

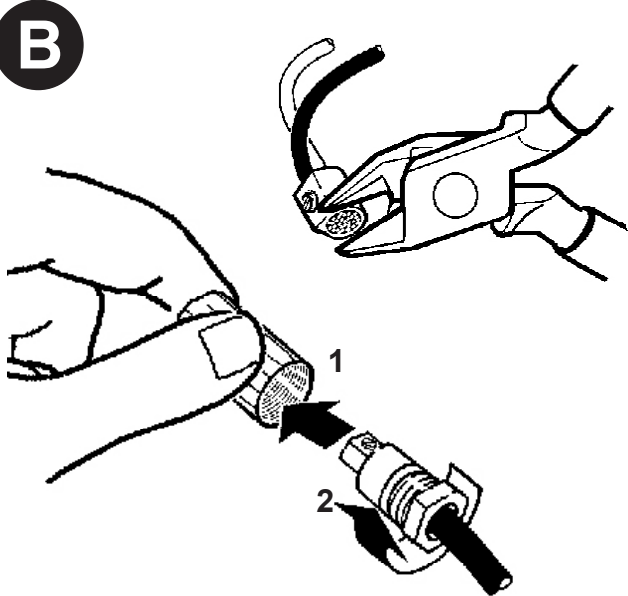

NASTRO AUTOAGGLOMERANTE  
 SELF-VULCANISING TAPE  
 RUBAN AUTO-SOUDABLE  
 SELBSTHAFTBAND - (Klebefilm SCOTCH 23 3M)  
 ZELFFUSERENDE TAPE  
 CINTA AUTOAGGLOMERANTE (SCOTCH 23 3M)  
 SELVKLÆBENDE BÅND  
 SELVVULKANISERENDE TAPE  
 SJÄLVBINDANDE BAND  
 САМОПЛАСТИФИЦИРУЮЩАЯСЯ ЛЕНТА  
 自硫化带

art. B915

**C**

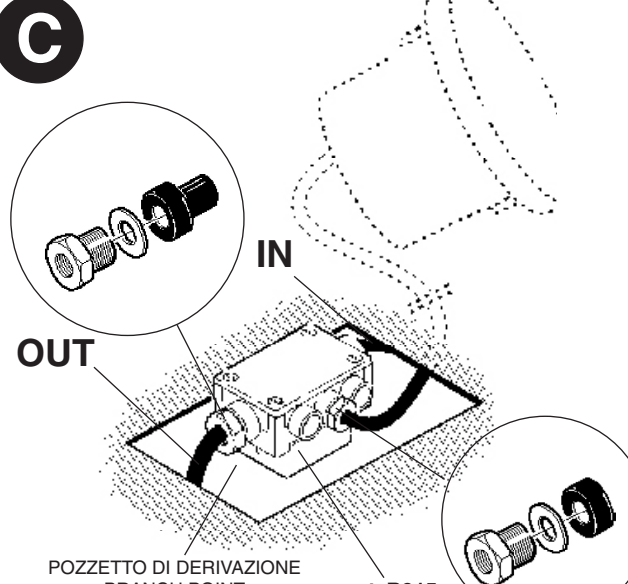

POZZETTO DI DERIVAZIONE  
 BRANCH POINT  
 TRAPPE POUR BOÎTE DE DÉRIVATION  
 ABZWEIGSCHACHT  
 CONTACTPUTJE  
 CAJA DE DERIVACIÓN  
 TILSLUTNINGSDÅSE  
 GRENPUNKT  
 KOPPLINGSBRUNN  
 УЗЛОВАЯ ТОЧКА  
 分支点

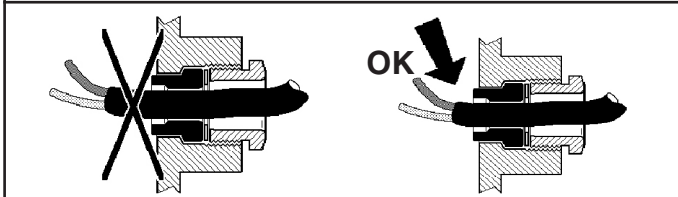
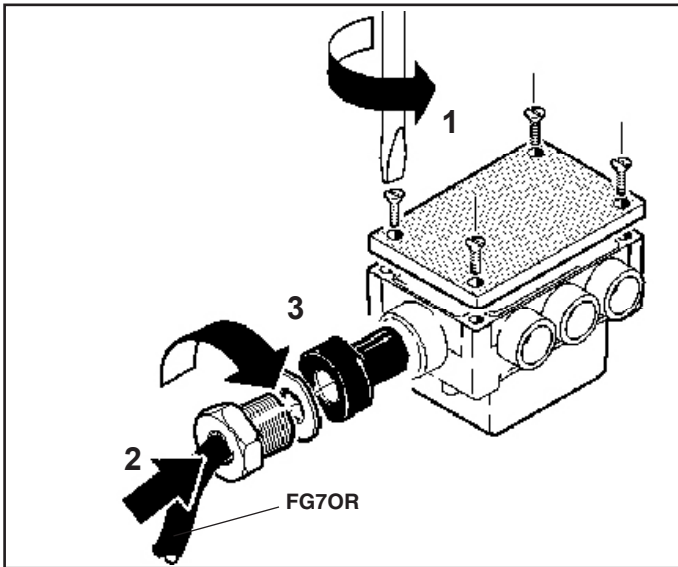

	D (mm)	Ø (mm)
	8,0 ÷ 10,0	8,5
	10,0 ÷ 12,5	11
	12,5 ÷ 14,5	13,5
	14,5 ÷ 16,0	15,5

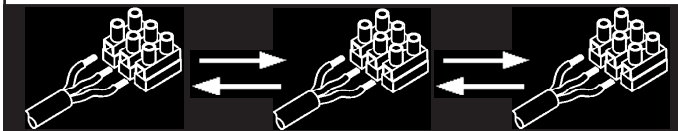
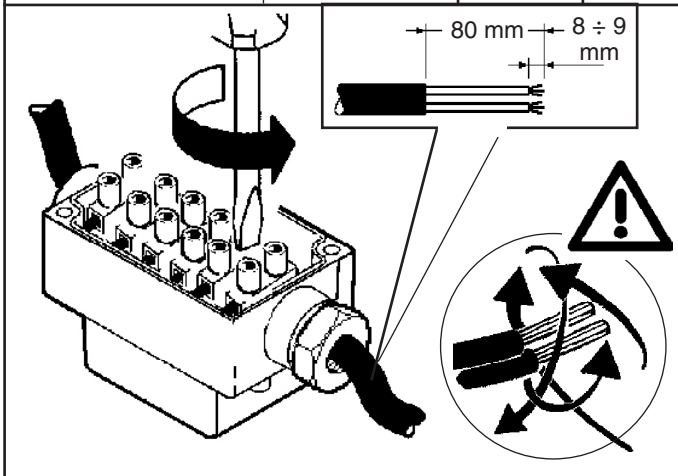

CABLAGGIO PASSANTE  
 FEEDTHROUGH WIRING  
 CABLAGE TRAVERSANT  
 DURCHGANGSKABEL  
 KABELDOORGANG  
 CABLEADO PASANTE  
 GENNEMGÅENDE LEDNINGER  
 FØRINGSKABLING  
 KABEL GENOMFØRING  
 СКВОЗНОЙ МОНТАЖ  
 连接线架设

**FG7OR**  
 2 x 1,5mm<sup>2</sup>  
 Ø MAX 16mm

ALIMENTAZIONE  
 POWER SUPPLY  
 ALIMENTATION  
 EINSPEISUNG  
 VOEDING  
 ALIMENTACIÓN  
 STRØMFORSYNING  
 STRØMTILFØRSEL  
 ELFÖRSÖRJNING  
 ЭЛЕКТРОПИТАНИЕ  
 能源

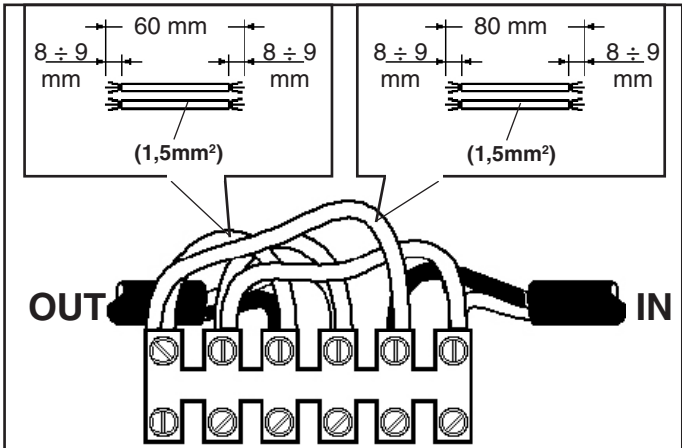

I N.B.: Verificare manualmente la tenuta dei cavi nel morsetto.  
 GB N.B.: Manually check the tightness of the cables in the terminal board.  
 F N.B.: Veuillez vérifier manuellement la tenue des fils dans la borne.  
 D NB: Der Halt der Drähte in der Klemme ist von Hand zu prüfen.  
 NL N.B.: Verifieer handmatig of de kabels goed in de klemmenstrook vastzitten.  
 E N.B.: Verificar manualmente la fijación de los cables en el terminal.  
 DK N.B.: Kontroller, at ledningerne i klemmen sidder ordentligt fast.  
 N N.B.: Kontroller tettheten til kablene i terminalkortet manuelt.  
 S OBS! Kontrollera för hand att kablarna sitter ordentligt fast i klämman.  
 RUS ПРИМЕЧАНИЕ: Проверьте вручную прочность соединения проводов к клеммам.  
 CN 注意: 手动检查接线排电缆的牢固性。

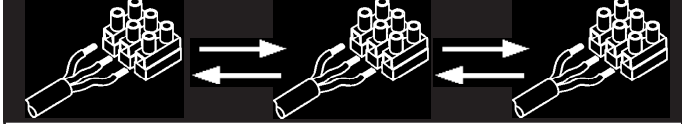

CABLAGGIO PASSANTE  
 FEEDTHROUGH WIRING  
 CABLAGE TRAVERSANT  
 DURCHGANGSKABEL  
 KABELDOORGANG  
 CABLEADO PASANTE  
 GENNEMGÅENDE LEDNINGER  
 FØRINGSKABLING  
 KABEL GENOMFØRING  
 СКВОЗНОЙ МОНТАЖ  
 连接线架设

**FG7OR**  
 2 x 1,5mm<sup>2</sup>  
 Ø MAX 16mm

ALIMENTAZIONE  
 POWER SUPPLY  
 ALIMENTATION  
 EINSPEISUNG  
 VOEDING  
 ALIMENTACIÓN  
 STRØMFORSYNING  
 STRØMTILFØRSEL  
 ELFÖRSÖRJNING  
 ЭЛЕКТРОПИТАНИЕ  
 能源

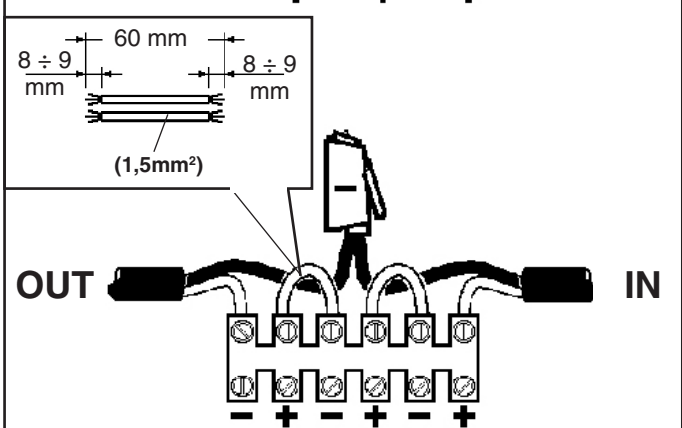

I N.B.: Verificare manualmente la tenuta dei cavi nel morsetto.  
 GB N.B.: Manually check the tightness of the cables in the terminal board.  
 F N.B.: Veuillez vérifier manuellement la tenue des fils dans la borne.  
 D NB: Der Halt der Drähte in der Klemme ist von Hand zu prüfen.  
 NL N.B.: Verifieer handmatig of de kabels goed in de klemmenstrook vastzitten.  
 E N.B.: Verificar manualmente la fijación de los cables en el terminal.  
 DK N.B.: Kontroller, at ledningerne i klemmen sidder ordentligt fast.  
 N N.B.: Kontroller tettheten til kablene i terminalkortet manuelt.  
 S OBS! Kontrollera för hand att kablarna sitter ordentligt fast i klämman.  
 RUS ПРИМЕЧАНИЕ: Проверьте вручную прочность соединения проводов к клеммам.  
 CN 注意: 手动检查接线排电缆的牢固性。

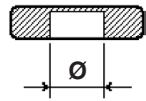
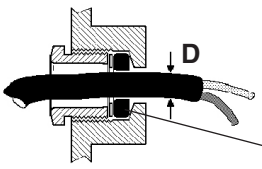
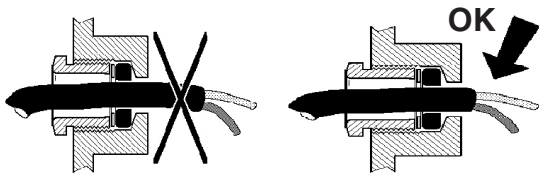
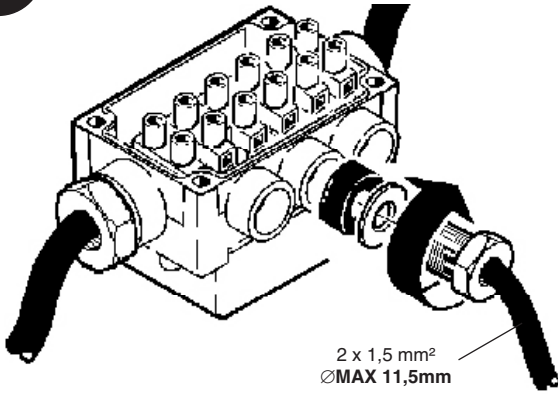
**D**

D ( mm )	Ø ( mm )
3,0 ÷ 5,0	3,9
6,5 ÷ 9,0	8,0
9,0 ÷ 11,5	10,5

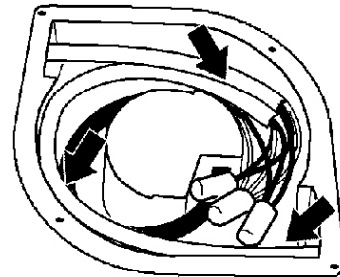
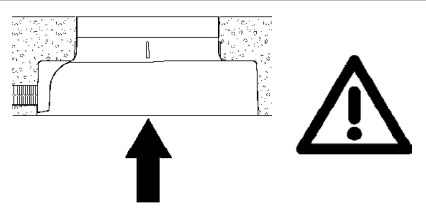
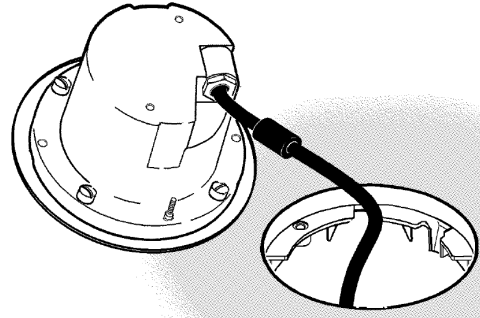
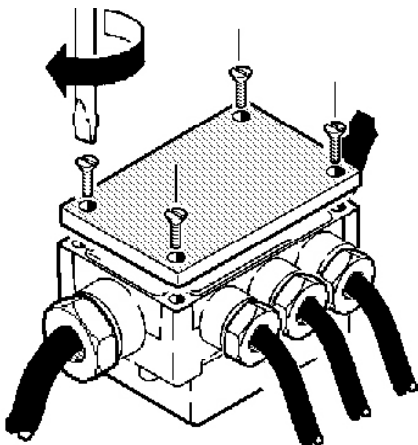
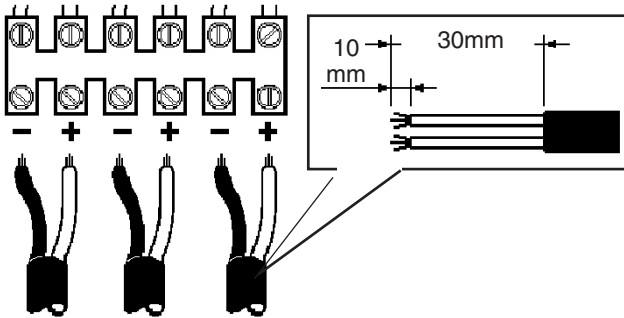

I Disporre i cavi ai lati dell'apparecchio come indicato in figura.

GB Arrange the cables on the sides of the luminaire as indicated in the figure.

F Placez les câbles sur les côtés de l'appareil comme illustré (voir figure).

D Ordnen Sie die Kabel wie in der Abbildung dargestellt an den Seiten der Leuchte an.

NL Plaats de kabels aan de zijanten van het apparaat zoals aangegeven in de afbeelding.

E Coloque los cables a los costados del aparato como lo indica la figura.

DK Anbring ledningerne på siderne af armaturet, som vist i figuren.

N Plasser kablene på siden av lysarmaturen slik som indikert på figuren.

S Placera kablarna på utrustningens sidor, som visas i figuren.

RUS Расположите провода по бокам прибора, как показано на схеме.

CN 如图所示在灯具侧排列电缆。

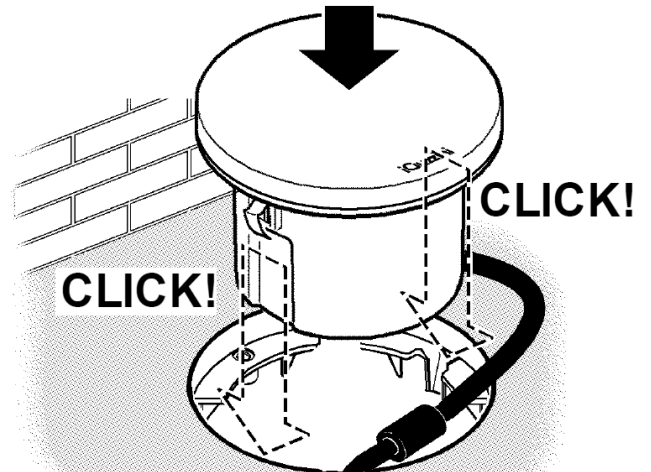

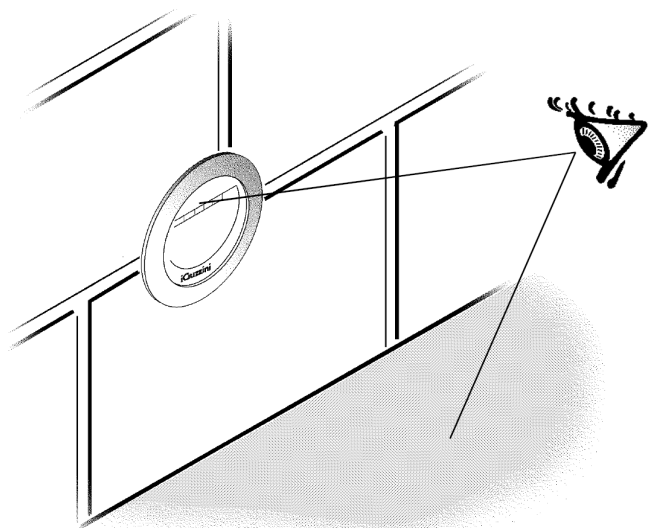
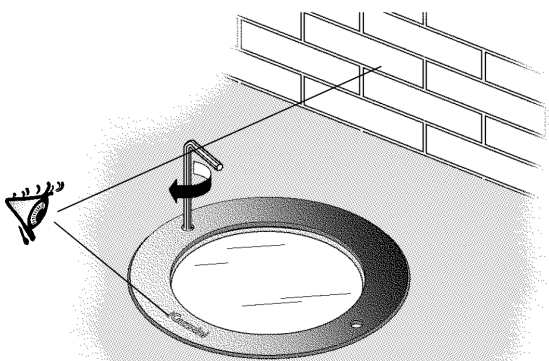
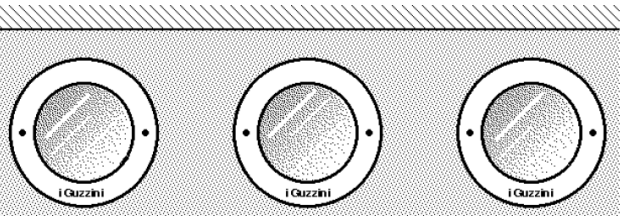
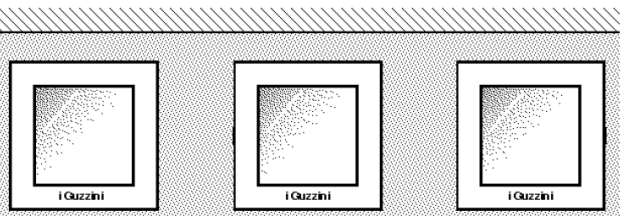

art. B281 - B319  
B300 - B337  
BB43 - BB44  
BB45 - BB46  
BB47 - BB48  
BB49 - BB50

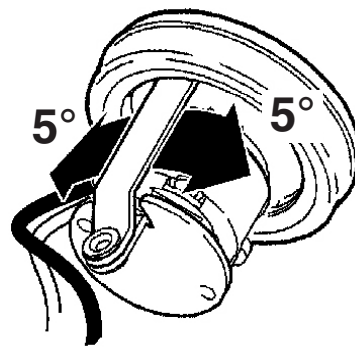
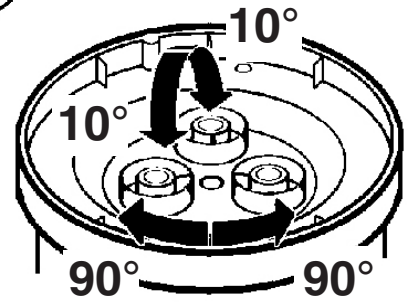
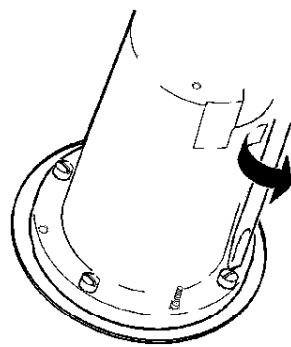

art. 9583

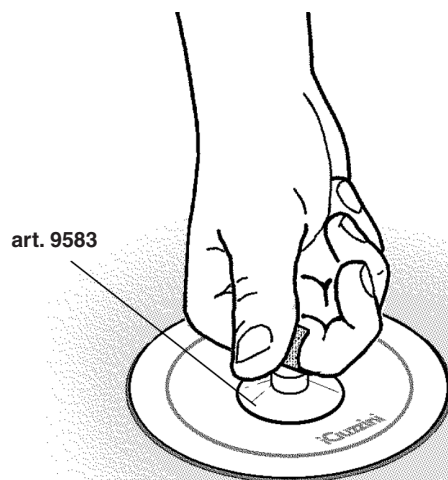

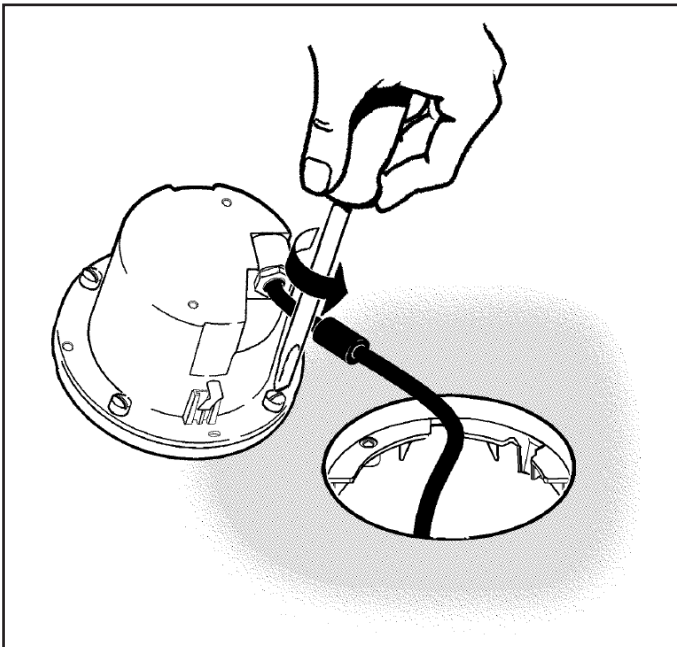

ART.	Filtro-Filter-Filtre Filter - Filter - Filtro Filter - Filter - Filter Фильтр 濾色鏡	PITTOGRAMMA PICTOGRAM PICTOGRAMME PIKTOGRAMM PICTOGRAMA PIKTOGRAM PIKTOGRAM BILDTECKEN ПИКТОГРАММА 象形图					
	Colorato - Coloured - Couleur Farbig - Gekleurd - Colorado Farvet - Färgat - Цветной 彩色的 Diffondente - Diffusing - Diffuseur für diffuses Licht - Verspreidend - Difusor Lys-sprejning - Spredning - Ljusdiffusionsglas Рассеиватель света 漫射						
2606 - 2607 - 2609	9568	-	-	-	-	-	-
2611 - 2612 - 2614 B276 - B278 - B285 B286 - BD72	-	-	-	-	-	-	-
2628 - 2629 - 2631 BD71 - B275	9570 9569	-	9584	9585	9586	9587	9588
B281 - BB43 - BB44	-	9569	-	-	-	-	-
B319 - BB45 - BB46 B328	-	9571	-	-	-	-	-
	-	-	9594	9595	9596	9597	9598

ART.	Filtro-Filter-Filtre Filter - Filter - Filtro Filter - Filter - Filter Фильтр 濾色鏡	PITTOGRAMMA PICTOGRAM PICTOGRAMME PIKTOGRAMM PICTOGRAMA PIKTOGRAM PIKTOGRAM BILDTECKEN ПИКТОГРАММА 象形图					
	Colorato - Coloured - Couleur Farbig - Gekleurd - Colorado Farvet - Färgat - Цветной 彩色的 Diffondente - Diffusing - Diffuseur für diffuses Licht - Verspreidend - Difusor Lys-sprejning - Spredning - Ljusdiffusionsglas Рассеиватель света 漫射						
2620 - 2621 - 2623	9572	-	-	-	-	-	-
2635 - 2636 2638 - 2640 BD73 - B294	9574 9573	9572	9589	9590	9591	9592	9593
B295 - B297 - B304 B305 - BD74	-	-	-	-	-	-	-
B300 - BB47 - BB48	-	9573	-	-	-	-	-
B337 - BB49 - BB50 B346	-	9575	-	-	-	-	-
	-	-	9608	9609	9610	9611	9612

art. 2628 - 2629 - 2631 - 2635 - 2636 - 2638 - 2640

- I E' possibile installare un pittogramma ed un filtro colorato.
- GB A pictogram and coloured filter may be installed.
- F Il est possible d'installer un pictogramme et un filtre coloré.
- D Es kann sowohl ein Piktogramm als auch ein Farbfilter installiert werden.
- NL Het is mogelijk een pictogram en een gekleurd filter te installeren.
- E Se pueden instalar un pictograma y un filtro cromático.
- DK Der kan installeres et piktogram og et farvefilter.
- N Et piktogram og farget filter kan installeres.
- S Det går att installera ett piktogram och ett färgat filter.
- RUS Можно установить одну пиктограмму и один цветной фильтр.
- CN 可安装象形图和彩色滤光器。

- GIALLO  
YELLOW  
JAUNE  
GELB  
GELB  
GUL  
GUL  
GUL  
ЖЕЛТЫЙ  
黄色
- CIANO  
CYAN  
CYAN  
ZYAN  
ZACHTBLA  
AZULADO  
BLÁVIOLET  
KORNBLÁ  
CYAN  
ВАСИЛЬКОВЫЙ  
青色
- ARANCIO  
ORANGE  
ORANGE  
ORANGE  
ORANJE  
ORANGE  
ORANGE  
ORANGE  
ORANSJE  
ORANGE  
ОРАНЖЕВЫЙ  
橘黄色
- OSCURATO  
DARKENED  
SOMBRE  
VERDUNKELT  
VERDUISTERD  
OSCURECIDO  
FORMØRKET  
FORMØRKET  
MÖRKLADG  
НЕ ОСВЕЩЕННЫЙ  
变暗的
- MAGENTA  
MAGENTA  
MAGENTA  
MAGENTA  
MAGENTA  
RÖDVIOLET  
MAGENTARØD  
MAGENTA  
ПУРПУРНЫЙ  
洋红色

- ☰ art. 9584 - 9589  
9594 - 9608
- ☷ art. 9585 - 9590  
9595 - 9609
- ⓘ art. 9586 - 9591  
9596 - 9510
- ➔ art. 9587 - 9592  
9597 - 9611
- ♂♀ art. 9588 - 9593  
9598 - 9612



**SOSTITUZIONE DEL LED  
REPLACING THE LED  
REPLACEMENT DE LA LED  
AUSTAUSCHEN DER LED  
VERVANGEN VAN DE LED  
REEMPLAZO DEL LED  
UDSKIFTNING AF LYSDIODE  
BYTE AV LYSDIOD  
UTSKIFTING AV DEN LYSEMITTERENDE DIODEN  
ЗАМЕНА СИД  
发光二极管替换**

I N.B.: Per la sostituzione del LED contattare l'azienda iGuzzini.

GB N.B.: For information on LED replacement please contact iGuzzini.

F N.B.: Pour procéder au remplacement de la LED, adressez-vous à la société iGuzzini.

D N.B.: Bezüglich des Austausches der LED kontaktieren Sie bitte die Firma iGuzzini.

NL N.B.: Voor het vervangen van de LED neemt u contact op met het bedrijf iGuzzini.

E NOTA: Para sustituir el LED llame a la empresa iGuzzini.

DK N.B.: For udskiftning af lysdioden, skal man kontakte iGuzzini.

N N.B.: For informasjon om skifte av LED, vennligst ta kontakt med iGuzzini.

S OBS! För byte av lysdioden, kontakta företaget iGuzzini.

RUS ПРИМЕЧАНИЕ: Для замены СИДов обращайтесь в компанию iGuzzini.

CN 注意：如需LED更换的信息，请联系iGuzzini。

**G**

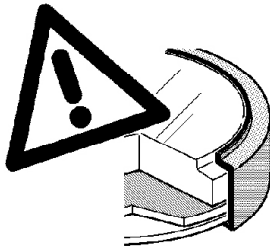
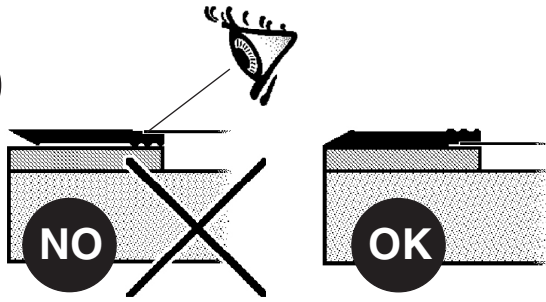

I Assicurarsi che la guarnizione "G" sia posizionata come in figura.

GB Make sure that the seal "G" is positioned as shown in the figure.

F Contrôlez que le joint "G" est bien monté comme illustré par la figure.

D Achten Sie darauf, daß die Dichtung "G" so wie in der Abbildung veranschaulicht aufgelegt wird.

NL Let erop dat de afdichting "G" geplaatst wordt zoals in de afbeelding.

E Comprobar que la junta "G" resulte en la posición indicada en figura.

DK Kontroller, at pakningen "G" sidder, som vist i figuren.

N Se til at forseglingen "G" er posisjonert slik som vist på figuren.

S Försäkra dig om att packningen "G" sitter korrekt som i figuren.

RUS Проверьте, чтобы уплотнение «G» было установлено, как показано на схеме.

CN 确认封条"G"如图所示放置。

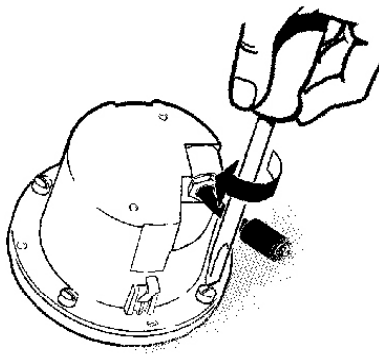

I Serrare le viti "V" passando da una vite a quella diametralmente opposta, accertandosi che siano posizionate al centro delle rispettive sedi sul prodotto.

GB Tighten screws "V" going from one screw to the one which is diametrically opposite, making sure that they are located in the centre of their respective housings on the product.

F Serrez les vis «V» dans l'ordre suivant: passez d'une vis à celle qui lui est diamétralement opposée et contrôlez qu'elles sont bien centrées dans leurs logements respectifs prévus sur le produit.

D Ziehen Sie die Schrauben „V“ zu, indem Sie immer erst eine Schraube, dann die ihr gegenüberliegende fest ziehen und sich dabei vergewissern, dass sich die Schrauben genau in der Mitte des auf dem Artikel vorgesehenen Loches befinden.

NL Draai de schroeven "V" aan, van een schroef naar de diametrisch tegenovergelegen, en let erop dat ze in het midden van hun respectievelijke behuizingen op het apparaat worden aangebracht.

E Apretar los tornillos «V» pasando de un tornillo al tornillo diametralmente opuesto, asegurándose de que los tornillos están colocados en el centro de sus sedes en el producto.

DK Spænd skruerne "V" i en diametral rækkefølge, og sørg for, at de sidder midt i deres sæder på produktet.

N Trekk til skruene "V" ved å gå fra én skruer til den som er diametrisk motsatt, slik at de plasseres i senter av respektive hus på produktet.

S Dra åt skruvarna "V". Korsdra dem och försäkra dig om att de sitter i mitten i förhållande till respektive säten på utrustningen.

RUS Закрутите шурупы "V", переходя от одного шурупа к противоположному, проверяя, чтобы шурупы были расположены в центрах своих гнезд в приборе.

CN 依次拧紧螺丝"V", 包括相对的螺丝, 确认螺丝安置于产品上各自壳体的中心。

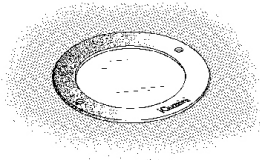

## LEDPLUS

تحذير:

لا يمكن ضمان سلامة هذا الجهاز إلا إذا التزمت بهذه التعليمات، يجب حفظها في مكان آمن.

### ATTENZIONE:

LA SICUREZZA DELL'APPARECCHIO E' GARANTITA SOLO CON L'USO APPROPRIATO DELLE SEGUENTI ISTRUZIONI; PERTANTO E' NECESSARIO CONSERVARLE.

### WARNING:

THE SAFETY OF THIS FIXTURE IS GUARANTEED ONLY IF YOU COMPLY WITH THESE INSTRUCTIONS; REMEMBER TO CONSERVE IN A SAFE PLACE.

### ATENCIÓN:

LA SEGURIDAD DEL APARATO SE GARANTIZA SOLO CUMPLIENDO CUIDADOSAMENTE LAS SIGUIENTES INSTRUCCIONES; POR ELLO, ES NECESARIO CONSERVARLAS.

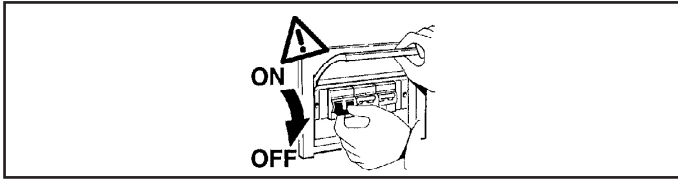

يجب عدم تغطية الجزء المركب، بأي حال من الأحوال، بمواد عازلة أو ما شابه ذلك.

I N.B.: L'apparecchio non deve, in alcuna circostanza, essere coperto con materiale isolante o similare.

GB N.B.: The fixture must not be covered, under any circumstances, by insulating materials or the like.

E NOTA: El aparato no debe ser protegido con material aislante o parecido, por ninguna causa.



ترتيب الأنابيب المجددة و/أو الكبلات الكهربائية، يجب مراجعة تصميم الجهاز.

I Per la disposizione dei tubi corrugati e/o dei cavi elettrici, fare riferimento al progetto dell'impianto.

GB See the system project for the arrangement of the corrugated pipes and/or electric cables.

E Para la ubicación de los tubos corrugados y/o de los cables eléctricos, hágase referencia al proyecto de la instalación.

ملاحظة: ملاحظة: أثناء تركيب نظام "LEDPLUS"، يجب التقيد بحرص بالنظم السائدة المتعلفة بالشبكة الكهربائية.

N.B.: DURANTE L'INSTALLAZIONE DEL SISTEMA "LEDPLUS" RISPETTARE SCRUPolosAMENTE LE NORME IMPIANTISTICHE VIGENTI.

N.B.: WHEN INSTALLING THE SYSTEM "LEDPLUS", STRICTLY COMPLY WITH ALL REGULATIONS ON INSTALLATION IN FORCE.

N.B.: DURANTE LA INSTALACIÓN DEL SISTEMA "LEDPLUS" RESPETAR ESCRUPolosAMENTE LAS NORMAS DE INSTALACIÓN VIGENTES.

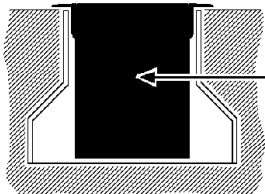

IP68 1m

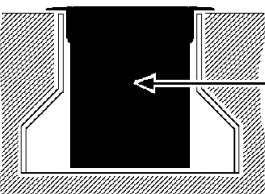

art. B318 - B319 - B320  
الاصنف B321 - B322 - B336  
IP67 B337 - B338 - B339  
B340 - BB45 - BB46  
BB49 - BB50

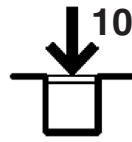

10000/5000N

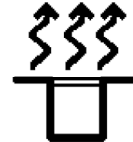

40°C

يستخدم المنتج المصمم للتعامل بحمل ثابت يصل إلى 10000 نيوتن. درجة الحرارة القصوى التي يمكن أن يتحملها المنتج هي 40°C. التركيب مسموح في المناطق المشاة، مسارات الدراجات.

I Gli apparecchi sono stati progettati e collaudati per reggere un carico statico fino a 10000 N; la temperatura massima rilevata sul vetro è di 40°C. L'installazione è ammessa in zone pedonali, piste ciclabili.

GB The fittings were designed and tested to withstand a static load up to 10000 N. The maximum temperature measured on the glass is 40°C. The fittings can be installed on pedestrian areas, cycle lanes.

E Los aparatos han sido diseñados y ensayados para resistir una carga estática de 10000 N; la temperatura máxima medida en el cristal es de 40°C. La instalación está permitida en zonas peatonales, pistas de bicicletas.

تنبيه: ينصح القيام بعملية التركيب والصيانة داخل الحجره البصرية أو في أجواء داخلية أو على الأقل في أماكن خالية من الرطوبة و المطر.

I N.B.: Si consiglia di effettuare le operazioni d'installazione o di manutenzione all'interno del vano ottico, in ambienti interni o quanto meno in assenza di umidità o pioggia.

GB N.B.: Installation and maintenance operations must be carried out inside the optical assembly, indoor and in a place with no humidity or rain.

E N.B.: Se recomienda efectuar las operaciones de instalación o mantenimiento dentro del cuerpo óptico, en interiores o por lo menos en ausencia de humedad o lluvia.

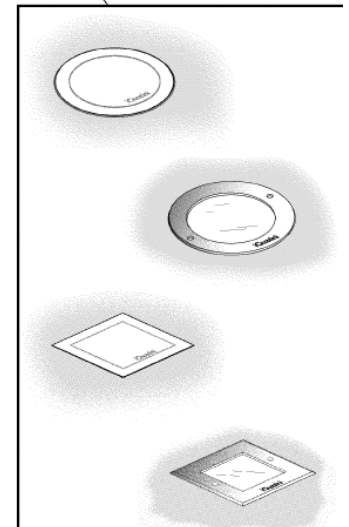
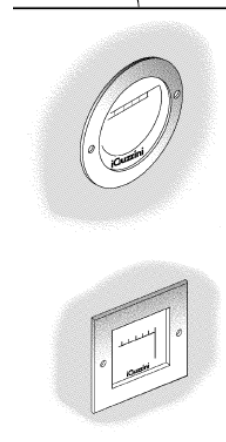
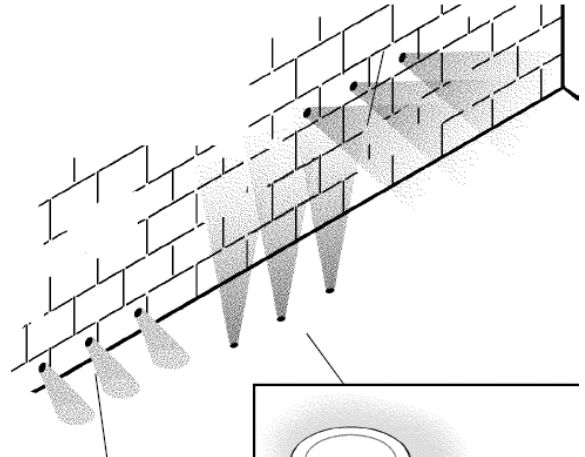
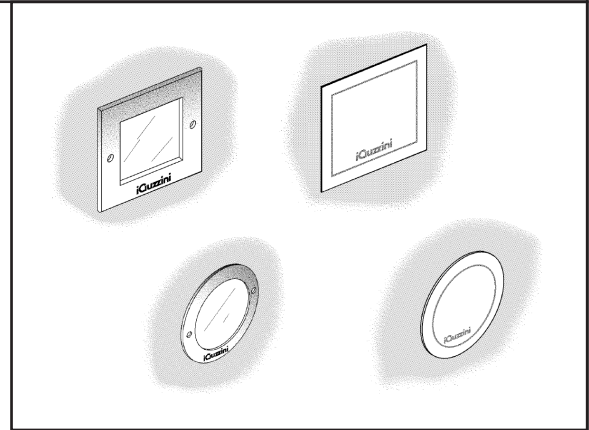

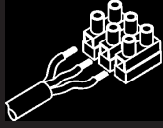

أو وصل المحوّل بالشبكة الكهربية فقط بعد توصيل المنتجات.

- I Cablare alla rete elettrica il trasformatore solo dopo aver effettuato il collegamento ai prodotti
- GB Wire the transformer to the electrical mains only after the connection to the products has been carried out
- E Cablear el transformador a la red eléctrica sólo después de conectar los productos

بوصى بتوفير الحماية الكافية للكابل، ومنعه من الاتصال المباشر بالأرض.

- I Si consiglia di proteggere adeguatamente il cavo dal contatto diretto con il terreno.
- GB The cable should be suitably protected against direct contact with the ground.
- E Se recomienda proteger adecuadamente el cable del contacto directo con el terreno.

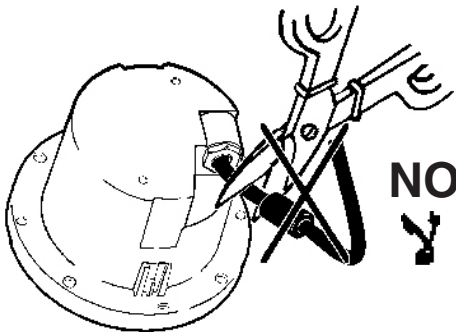
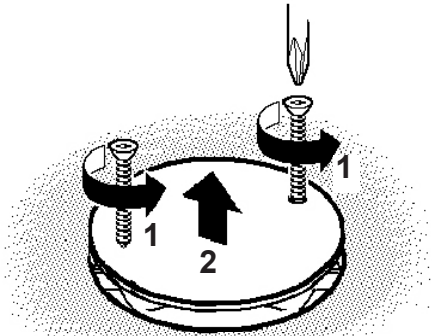

في حال تلف الكابل الخارجي المرص، يجب تغييره من قبل المصنع أو من قبل مركز الخدمة المحوّل أو من قبل أحد أعضاء الطاقم الملاّمين والمؤهلين وذلك لتحاكي إلحاق أي خطر.

- I In caso di danneggiamento del cavo flessibile esterno, questo deve essere sostituito dal costruttore, o dal suo servizio di assistenza, o da personale qualificato equivalente, al fine di evitare pericoli.
- GB Should the outer flexible cable be somehow damaged, the latter should be replaced by the manufacturer, or by the corresponding service centre, or by an appropriate and qualified member of staff in order to avoid all risk of danger.
- E En caso de daños el cable flexible externo debe substituirse por el fabricante, su servicio de asistencia o personal calificado equivalente para evitar peligros.

مصدر التيار  
ALIMENTAZIONE  
POWER SUPPLY  
CEBADOR

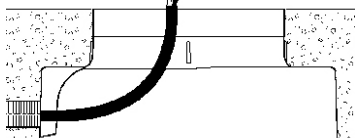
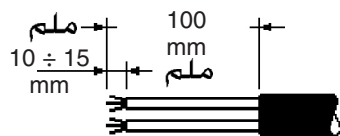

24V  $\equiv$   
220/240V  $\approx$

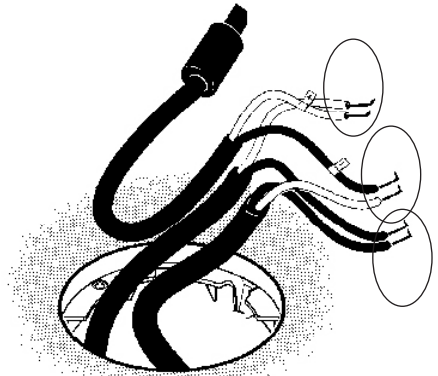
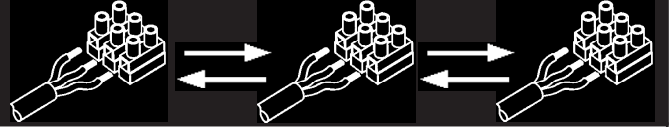

## EFFECT EQUALIZER

24V  $\equiv$   
220/240V  $\approx$

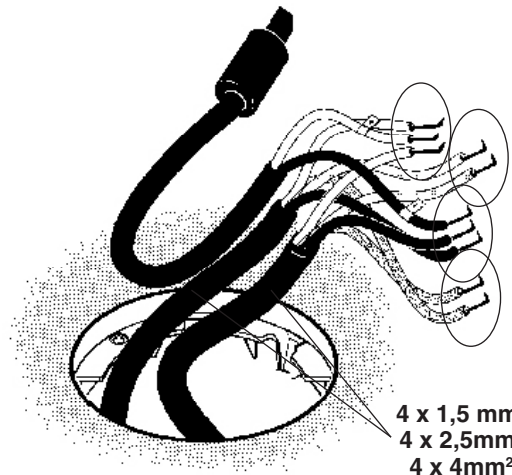
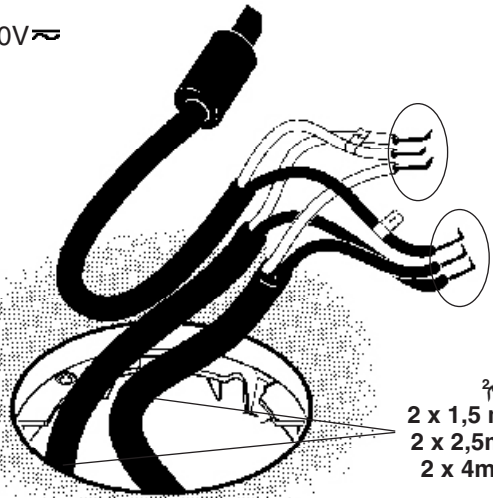

# COLOUR EQUALIZER

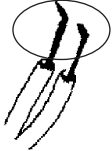
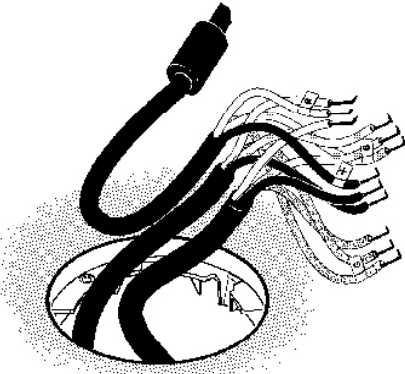

(العربية) جهد منخفض

LOW VOLTAGE == **A** **B** **C**

220/240V ~ **C**

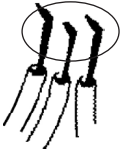

(العربية) جهد منخفض

LOW VOLTAGE == **B** **C**

220/240V ~ **C**

الصف art. 9581

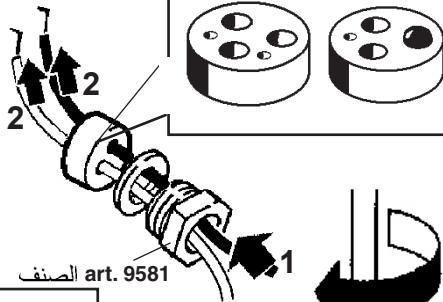
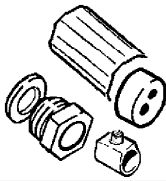

الصف art. 9581

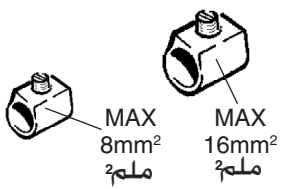

MAX  
8mm<sup>2</sup>  
ملم<sup>2</sup>

MAX  
16mm<sup>2</sup>  
ملم<sup>2</sup>

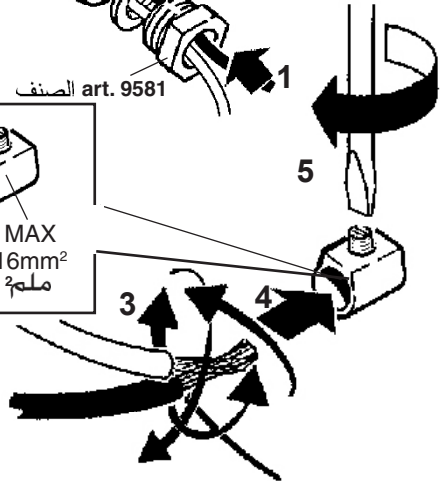

تنبيه: تحقق يدوياً من مناعة الكيبلات داخل طرف التوصيل.

I N.B.: Verificare manualmente la tenuta dei cavi nel morsetto.

GB N.B.: Manually check the tightness of the cables in the terminal board.

E N.B.: Verificar manualmente la fijación de los cables en el terminal.

**A**

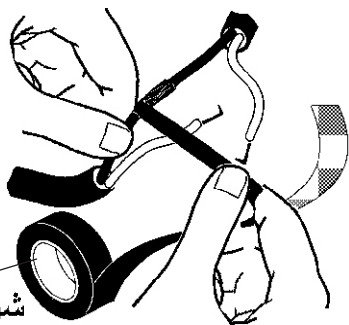

شريط يتكثّل بشكل ذاتي

NASTRO AUTOAGGLOMERANTE  
SELF-VULCANISING TAPE  
CINTA AUTOAGLOMERANTE  
(SCOTCH 23 3M)

STAGNARE  
WELD  
ESTANAR

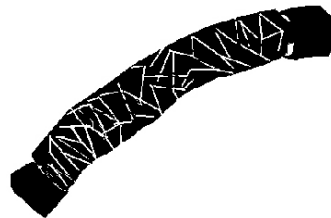
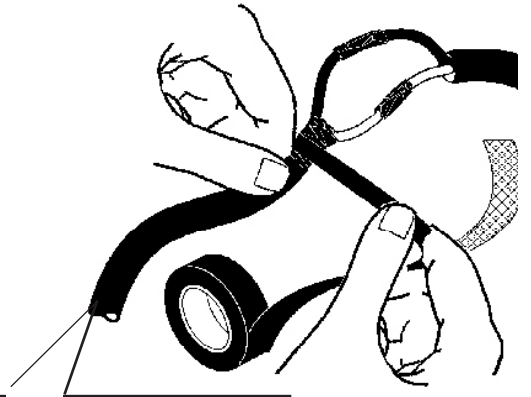
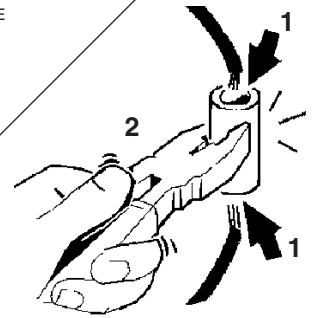

**B**

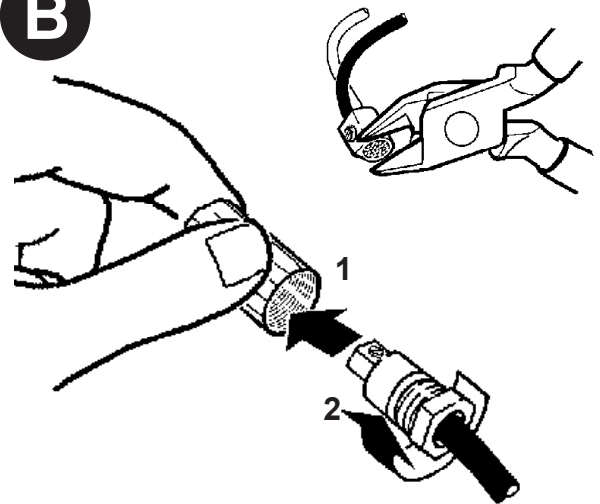

شريط يتكثّل بشكل ذاتي

NASTRO AUTOAGGLOMERANTE  
SELF-VULCANISING TAPE  
CINTA AUTOAGLOMERANTE  
(SCOTCH 23 3M)

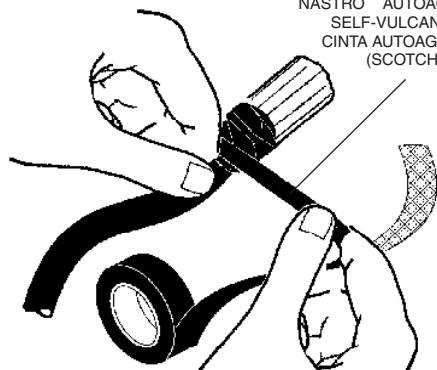

**C**

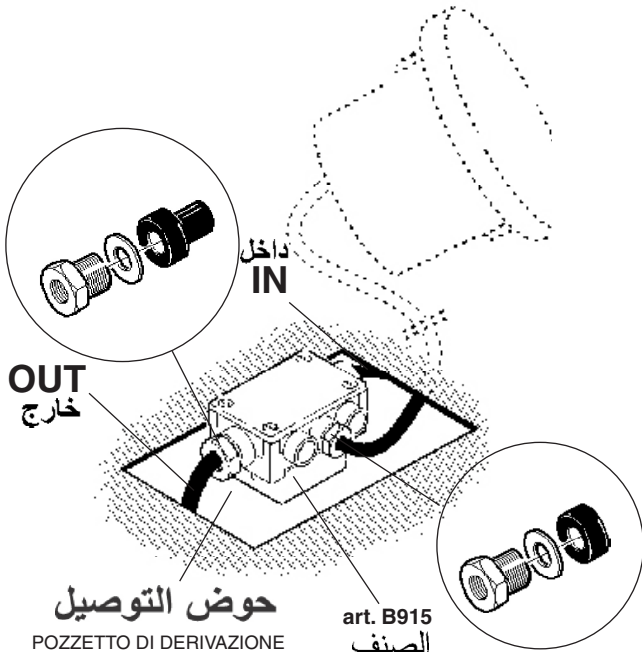

حوض التوصيل  
POZZETTO DI DERIVAZIONE  
BRANCH POINT  
CAJA DE DERIVACION

art. B915  
الصنف

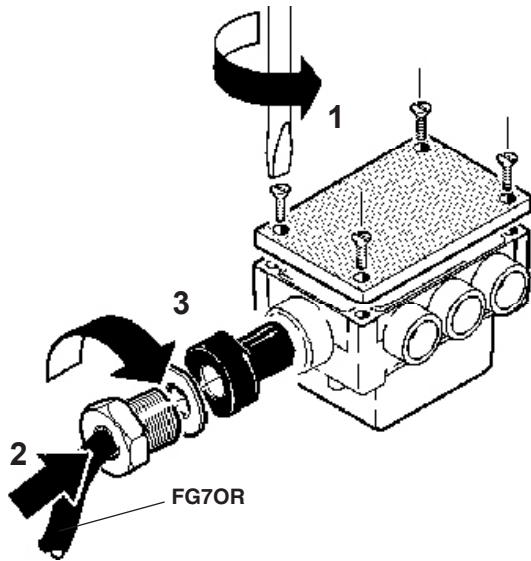

FG7OR

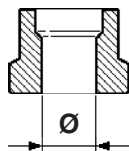
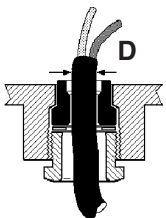
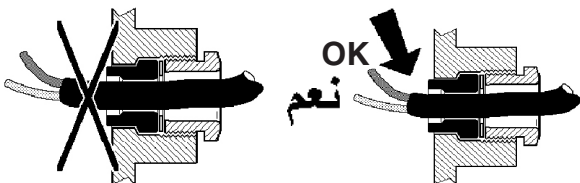

D (mm) ملم	Ø (mm) ملم
8,0 ÷ 10,0	8,5
10,0 ÷ 12,5	11
12,5 ÷ 14,5	13,5
14,5 ÷ 16,0	15,5

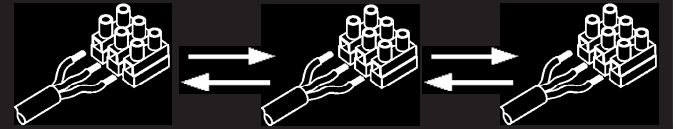
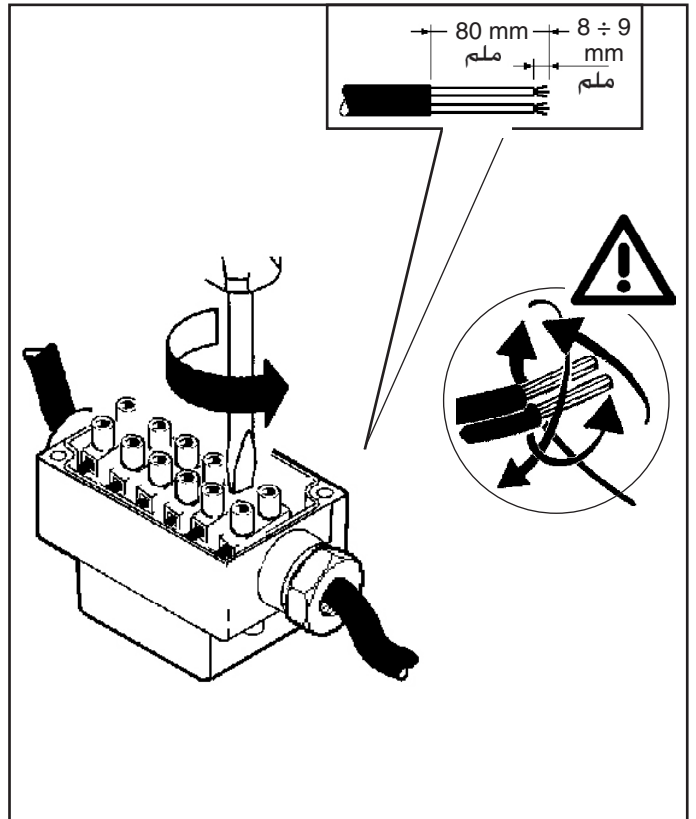

التسليك من خلال  
CABLAGGIO PASSANTE  
FEEDTHROUGH WIRING  
CABLEADO PASANTE

FG7OR  
2 x 1,5mm<sup>2</sup> ملم  
ØMAX 16mm ملم

مصدر التيار  
ALIMENTAZIONE  
POWER SUPPLY  
CEBADOR

OUT  
خارج

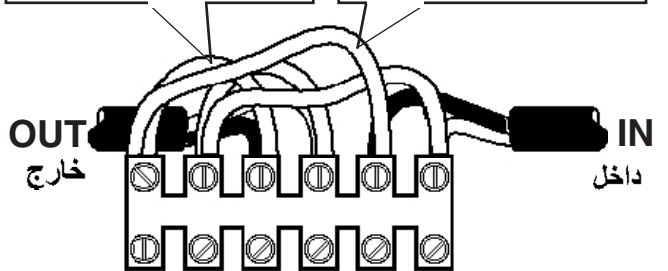
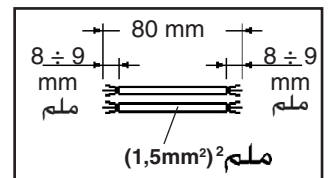
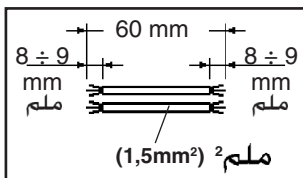
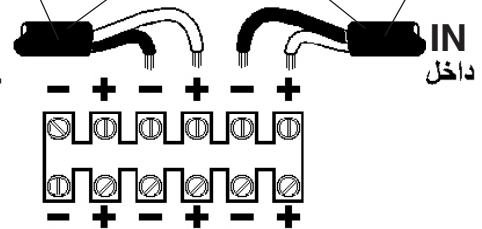

تنبيه: تحقق يدويا من مناعة الكيبلات داخل طرف التوصيل. عر

I N.B.: Verificare manualmente la tenuta dei cavi nel morsetto.

GB N.B.: Manually check the tightness of the cables in the terminal board.

E N.B.: Verificar manualmente la fijación de los cables en el terminal.

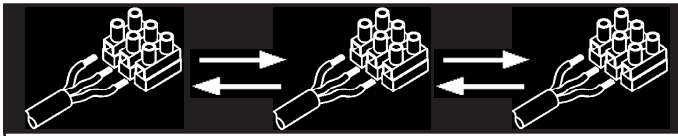

FG7OR  
2 x 1,5mm<sup>2</sup> ملم  
ØMAX 16mm ملم

التسليك من خلال  
CABLAGGIO PASSANTE  
FEEDTHROUGH WIRING  
CABLEADO PASANTE

مصدر التيار  
ALIMENTAZIONE  
POWER SUPPLY  
CEBADOR

OUT IN

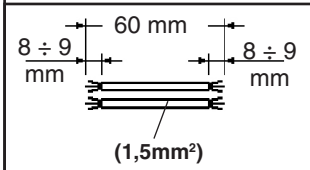
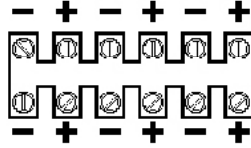

OUT IN

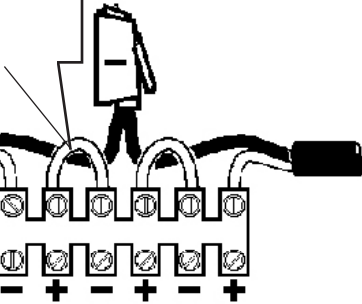

تنبيه: تحقق يدويا من مناعة الكيبلات داخل طرف التوصيل.

I N.B.: Verificare manualmente la tenuta dei cavi nel morsetto.

GB N.B.: Manually check the tightness of the cables in the terminal board.

E N.B.: Verificar manualmente la fijación de los cables en el terminal.

**D**

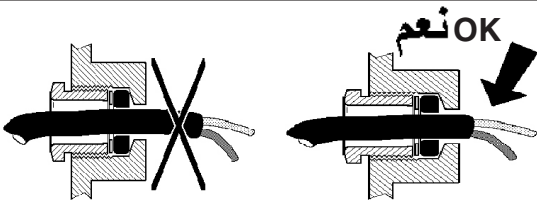
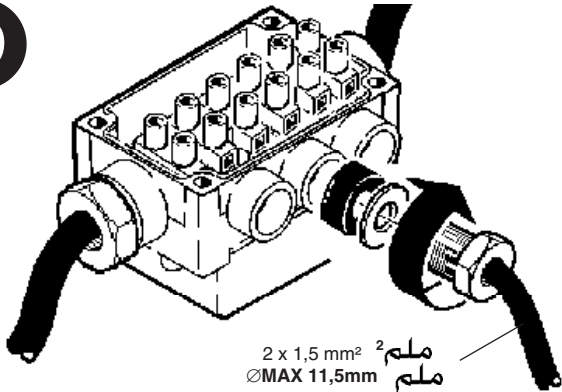

	D (mm) ملم	Ø (mm) ملم
	3,0 ÷ 5,0	3,9
	6,5 ÷ 9,0	8,0
	9,0 ÷ 11,5	10,5

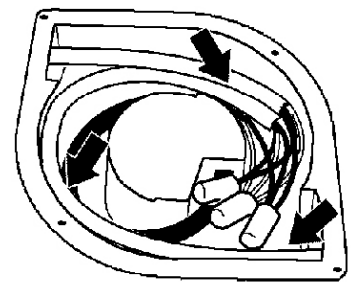
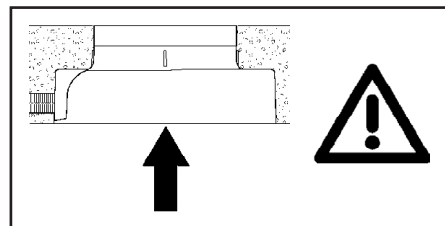
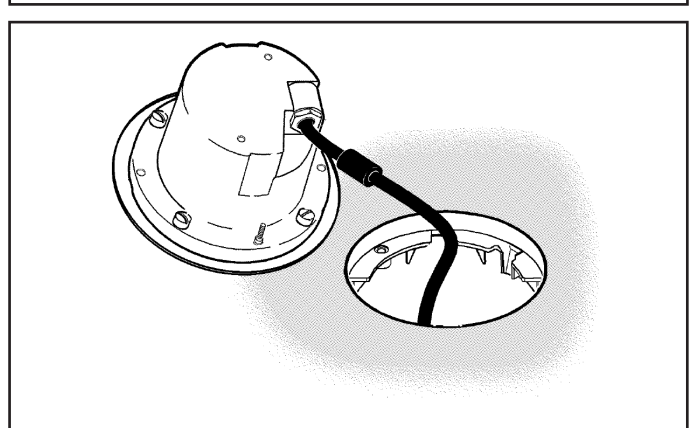
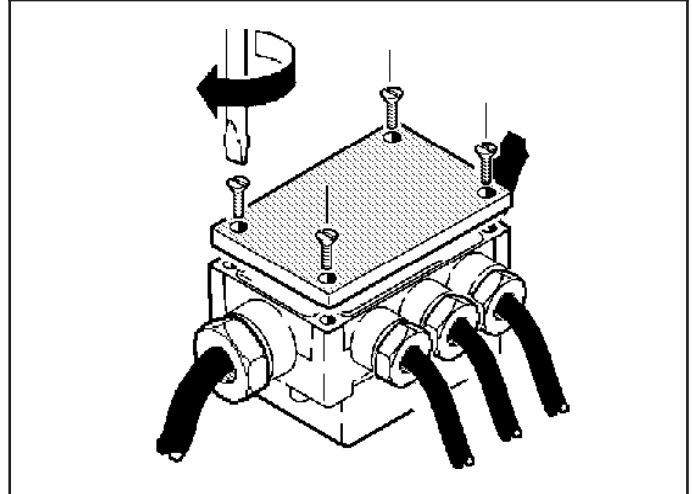
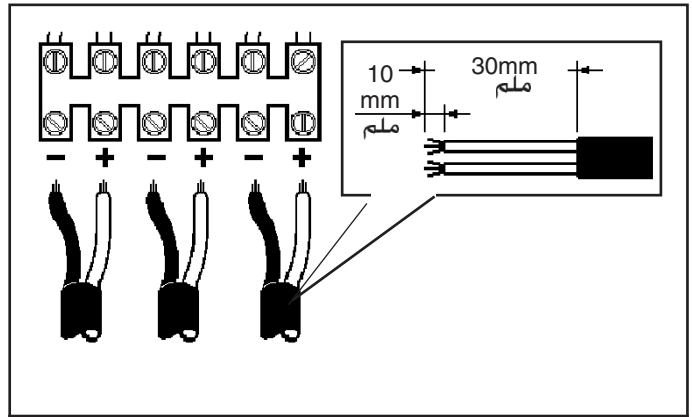

ع  
ضع الكيبلات على جوانب الجهاز كما هو مبين في الشكل.

I Disporre i cavi ai lati dell'apparecchio come indicato in figura.

GB Arrange the cables on the sides of the luminaire as indicated in the figure.

E Coloque los cables a los costados del aparato como lo indica la figura.

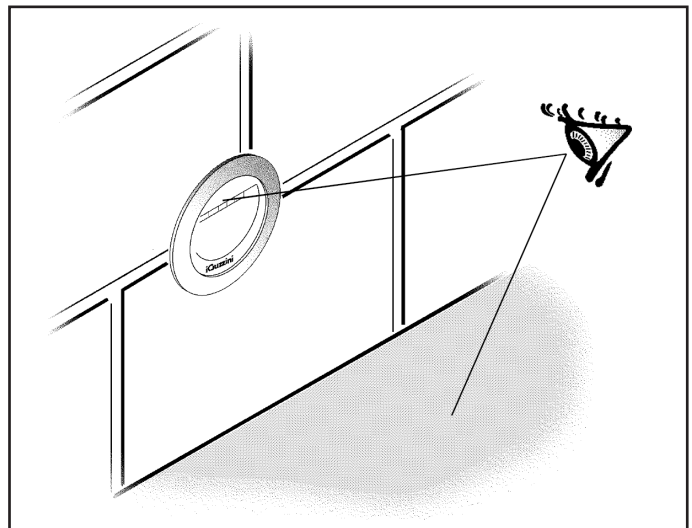
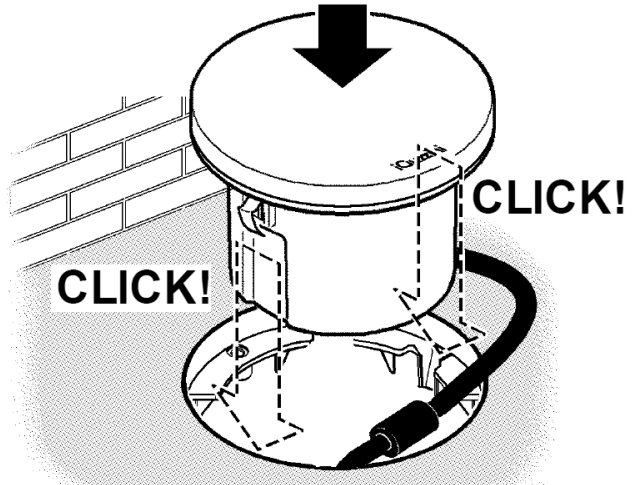
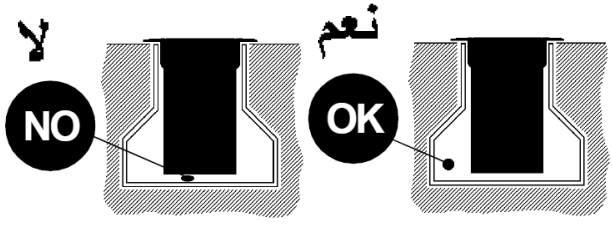

الصف art. B281 - B319  
 B300 - B337  
 BB43 - BB44  
 BB45 - BB46  
 BB47 - BB48  
 BB49 - BB50

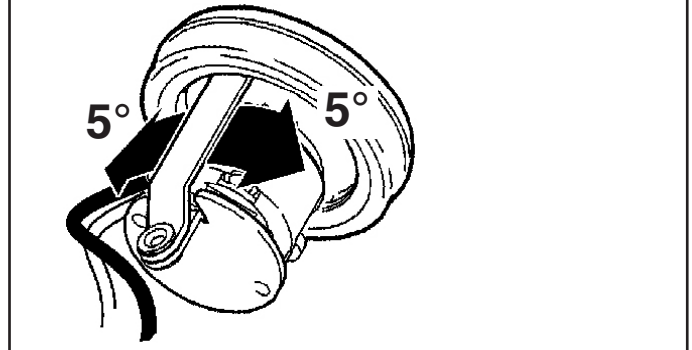
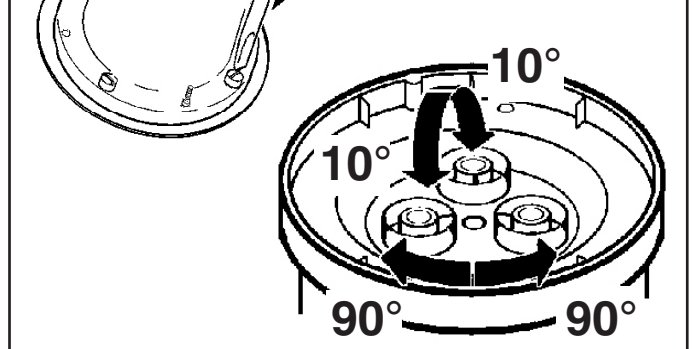

الصف art. 9583

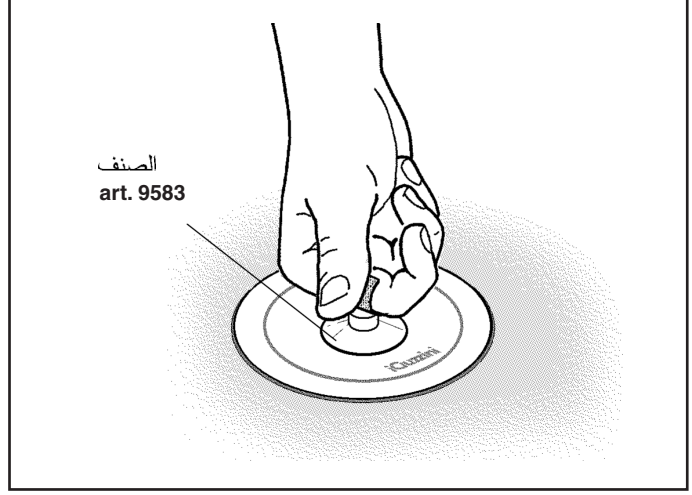
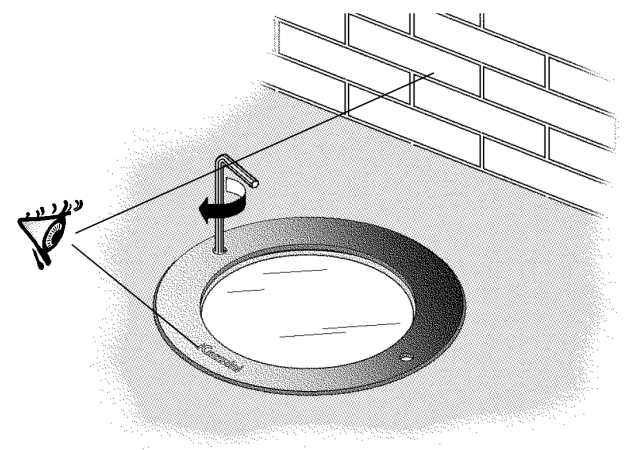
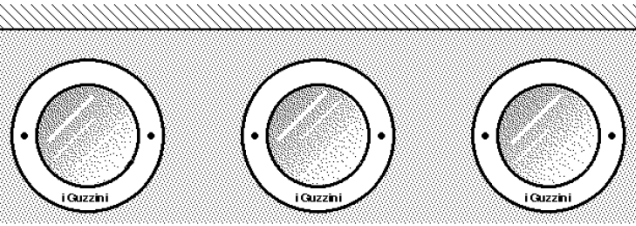
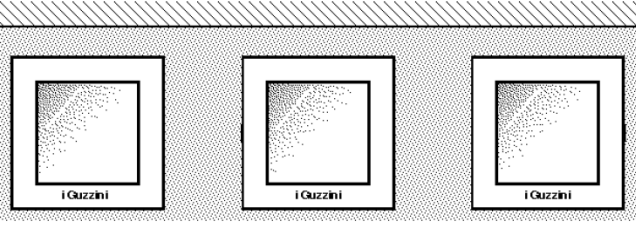

يمكن تركيب مصور توضيحي و فلتر ملون.  
 E' possibile installare un pittogramma ed un filtro colorato.  
 GB A pictogram and coloured filter may be installed.  
 E Se pueden instalar un pictograma y un filtro cromático.

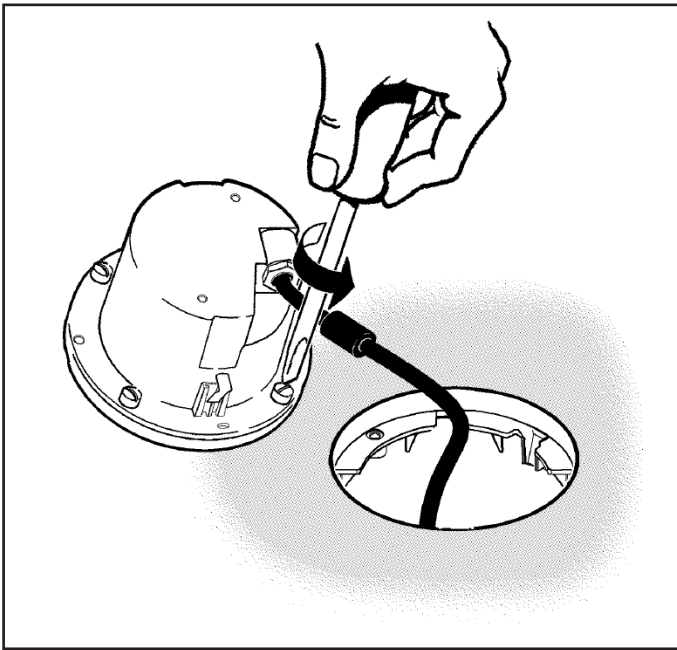

الصف ART.	فلتر الصنف Filtro - Filter - Filtro art.		مصور توضيحي PITTOGRAMMA PICTOGRAM PICTOGRAMA art.				
	ملون Colorato - Coloured - Colorado	ناشر Diffondente - Diffusing - Diffusor					
2606 - 2607 - 2609	9568	-	-	-	-	-	-
2611 - 2612 - 2614 B276 - B278 - B285 B286 - BD72	-	-	-	-	-	-	-
2628 - 2629 - 2631 BD71 - B275	9570 9569	-	9584	9585	9586	9587	9588
B281 - BB43 - BB44	-	9569	-	-	-	-	-
B319 - BB45 - BB46 B328	-	9571	-	-	-	-	-
	-	-	9594	9595	9596	9597	9598

الصف ART.	فلتر الصنف Filtro - Filter - Filtro art.		مصور توضيحي PITTOGRAMMA PICTOGRAM PICTOGRAMA art.				
	ملون Colorato - Coloured - Colorado	ناشر Diffondente - Diffusing - Diffusor					
2620 - 2621 - 2623	9572	-	-	-	-	-	-
2635 - 2636 2638 - 2640 BD73 - B294	9574 9573	9572	9589	9590	9591	9592	9593
B295 - B297 - B304 B305 - BD74	-	-	-	-	-	-	-
B300 - BB47 - BB48	-	9573	-	-	-	-	-
B337 - BB49 - BB50 B346	-	9575	-	-	-	-	-
	-	-	9608	9609	9610	9611	9612

أصفر  
GIALLO  
YELLOW  
AMARILLO

أزرق  
CIANO  
CYAN  
AZULADO

برتقالي  
ARANCIO  
ORANGE  
ORANJE

معتّم  
OSCURATO  
DARKENED  
OSCURICIDO

أحمر يميل إلى  
الأرجواني  
MAGENTA  
MAGENTA  
MAGENTA

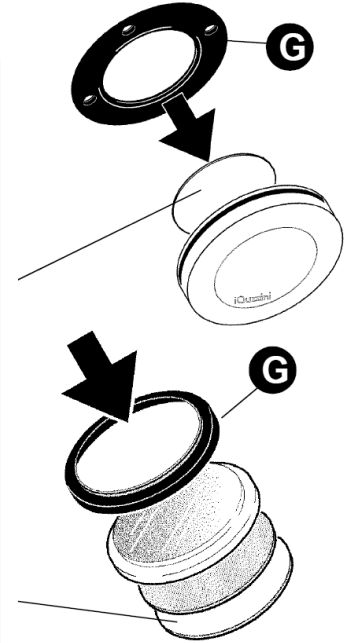

- الصف art. 9584
- الصف art. 9594
- الصف art. 9585 - 9590
- الصف art. 9595
- الصف art. 9586
- الصف art. 9596
- الصف art. 9587
- الصف art. 9597
- الصف art. 9588
- الصف art. 9598

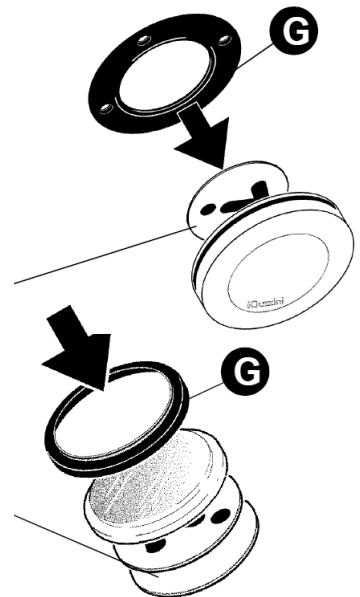



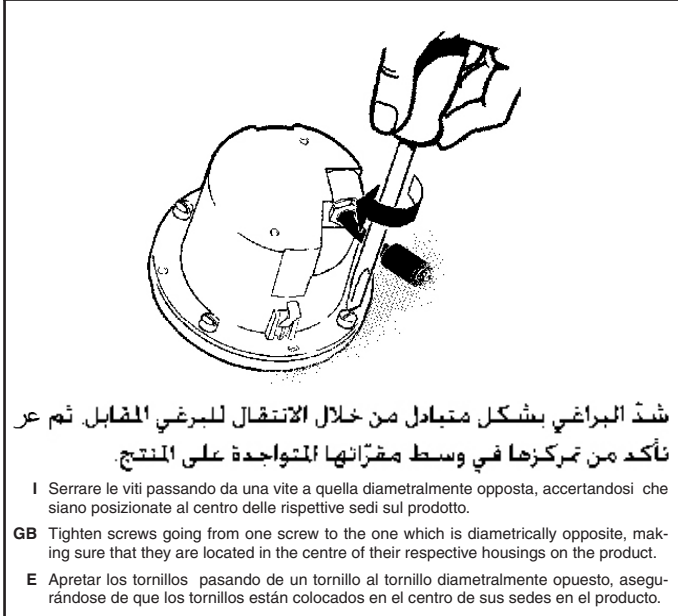
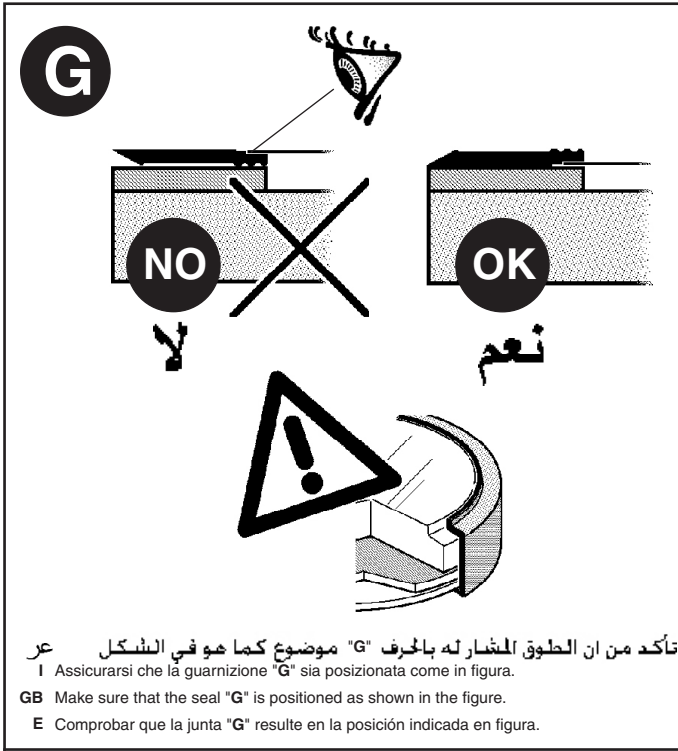

## استبدال الضوء LED

SOSTITUZIONE DEL LED  
REPLACING THE LED  
REEMPLAZO DEL LED

تنبیه: لاستبدال الضوء LED اتصل بشركة iGuzzini . عر

I N.B.: Per la sostituzione del LED contattare l'azienda iGuzzini.

GB N.B.: For information on LED replacement please contact iGuzzini.

E NOTA: Para sustituir el LED llame a la empresa iGuzzini.

1.154.544.00

IS00766/05

**SOSTITUZIONE DEL LED**  
**REPLACING THE LED**  
**REPLACEMENT DE LA LED**  
**AUSTAUSCHEN DER LED**  
**VERVANGEN VAN DE LED**  
**REEMPLAZO DEL LED**  
**UDSKIFTNING AF LYSDIODE**  
**BYTE AV LYSDIOD**  
**UTSKIFTING AV DEN LYSEMITTERENDE DIODEN**  
**ЗАМЕНА СИДа**  
**发光二极管替换**

**I N.B.:** Per la sostituzione del LED contattare l'azienda iGuzzini.

**GB N.B.:** For information on LED replacement please contact iGuzzini.

**F N.B.:** Pour procéder au remplacement de la LED, adressez-vous à la société iGuzzini.

**D N.B.:** Bezüglich des Austausches der LED kontaktieren Sie bitte die Firma iGuzzini.

**NL N.B.:** Voor het vervangen van de LED neemt u contact op met het bedrijf iGuzzini.

**E NOTA:** Para sustituir el LED llame a la empresa iGuzzini.

**DK N.B.:** For udskiftning af lysdioden, skal man kontakte iGuzzini.

**N N.B.:** For informasjon om skifte av LED, vennligst ta kontakt med iGuzzini.

**S OBS!** För byte av lysdioden, kontakta företaget iGuzzini.

**RUS ПРИМЕЧАНИЕ:**Для замены СИДов обращайтесь в компанию iGuzzini.

**CN 注意:** 如需LED更换的信息, 请联系iGuzzini.

**I** Gruppo di rischio 1, secondo norma **EN 62471: 2008**  
**GB** Risk Group: 1, in compliance with Standard **EN 62471: 2008**  
**FR** Groupe de risque 1, suivant la norme **EN 62471 : 2008**  
**DE** Risikogruppe 1, gemäß Vorschrift **EN 62471: 2008**  
**NL** Risicogroep 1, volgens de norm **EN 62471: 2008**  
**E** Grupo de riesgo 1, según norma **EN 62471: 2008**  
**DK** Faregruppe 1 i henhold til standarden **EN 62471: 2008**  
**N** Risikogruppe 1, i henhold til forskriften **EN 62471: 2008**  
**S** Riskgrupp 1, enligt standard **EN 62471: 2008**  
**RUS** GROUP РИСК 1 В СООТВЕТСТВИИ СО **EN 62471: 2008**

**CN** 风险组:1  
灯具和灯具系统的光生物学安全性符合标准 **EN 62471: 2008**

**iGuzzini**

1.154.544.00

IS00766/05

**SOSTITUZIONE DEL LED**  
**REPLACING THE LED**  
**REPLACEMENT DE LA LED**  
**AUSTAUSCHEN DER LED**  
**VERVANGEN VAN DE LED**  
**REEMPLAZO DEL LED**  
**UDSKIFTNING AF LYSDIODE**  
**BYTE AV LYSDIOD**  
**UTSKIFTING AV DEN LYSEMITTERENDE DIODEN**  
**ЗАМЕНА СИДа**  
**发光二极管替换**

**I N.B.:** Per la sostituzione del LED contattare l'azienda iGuzzini.

**GB N.B.:** For information on LED replacement please contact iGuzzini.

**F N.B.:** Pour procéder au remplacement de la LED, adressez-vous à la société iGuzzini.

**D N.B.:** Bezüglich des Austausches der LED kontaktieren Sie bitte die Firma iGuzzini.

**NL N.B.:** Voor het vervangen van de LED neemt u contact op met het bedrijf iGuzzini.

**E NOTA:** Para sustituir el LED llame a la empresa iGuzzini.

**DK N.B.:** For udskiftning af lysdioden, skal man kontakte iGuzzini.

**N N.B.:** For informasjon om skifte av LED, vennligst ta kontakt med iGuzzini.

**S OBS!** För byte av lysdioden, kontakta företaget iGuzzini.

**RUS ПРИМЕЧАНИЕ:**Для замены СИДов обращайтесь в компанию iGuzzini.

**CN 注意:** 如需LED更换的信息, 请联系iGuzzini.

**I** Gruppo di rischio 1, secondo norma **EN 62471: 2008**  
**GB** Risk Group: 1, in compliance with Standard **EN 62471: 2008**  
**FR** Groupe de risque 1, suivant la norme **EN 62471 : 2008**  
**DE** Risikogruppe 1, gemäß Vorschrift **EN 62471: 2008**  
**NL** Risicogroep 1, volgens de norm **EN 62471: 2008**  
**E** Grupo de riesgo 1, según norma **EN 62471: 2008**  
**DK** Faregruppe 1 i henhold til standarden **EN 62471: 2008**  
**N** Risikogruppe 1, i henhold til forskriften **EN 62471: 2008**  
**S** Riskgrupp 1, enligt standard **EN 62471: 2008**  
**RUS** GROUP РИСК 1 В СООТВЕТСТВИИ СО **EN 62471: 2008**

**CN** 风险组:1  
灯具和灯具系统的光生物学安全性符合标准 **EN 62471: 2008**

**iGuzzini**

1.154.544.00

IS00766/05

**SOSTITUZIONE DEL LED**  
**REPLACING THE LED**  
**REPLACEMENT DE LA LED**  
**AUSTAUSCHEN DER LED**  
**VERVANGEN VAN DE LED**  
**REEMPLAZO DEL LED**  
**UDSKIFTNING AF LYSDIODE**  
**BYTE AV LYSDIOD**  
**UTSKIFTING AV DEN LYSEMITTERENDE DIODEN**  
**ЗАМЕНА СИДа**  
**发光二极管替换**

**I N.B.:** Per la sostituzione del LED contattare l'azienda iGuzzini.

**GB N.B.:** For information on LED replacement please contact iGuzzini.

**F N.B.:** Pour procéder au remplacement de la LED, adressez-vous à la société iGuzzini.

**D N.B.:** Bezüglich des Austausches der LED kontaktieren Sie bitte die Firma iGuzzini.

**NL N.B.:** Voor het vervangen van de LED neemt u contact op met het bedrijf iGuzzini.

**E NOTA:** Para sustituir el LED llame a la empresa iGuzzini.

**DK N.B.:** For udskiftning af lysdioden, skal man kontakte iGuzzini.

**N N.B.:** For informasjon om skifte av LED, vennligst ta kontakt med iGuzzini.

**S OBS!** För byte av lysdioden, kontakta företaget iGuzzini.

**RUS ПРИМЕЧАНИЕ:**Для замены СИДов обращайтесь в компанию iGuzzini.

**CN 注意:** 如需LED更换的信息, 请联系iGuzzini.

**I** Gruppo di rischio 1, secondo norma **EN 62471: 2008**  
**GB** Risk Group: 1, in compliance with Standard **EN 62471: 2008**  
**FR** Groupe de risque 1, suivant la norme **EN 62471 : 2008**  
**DE** Risikogruppe 1, gemäß Vorschrift **EN 62471: 2008**  
**NL** Risicogroep 1, volgens de norm **EN 62471: 2008**  
**E** Grupo de riesgo 1, según norma **EN 62471: 2008**  
**DK** Faregruppe 1 i henhold til standarden **EN 62471: 2008**  
**N** Risikogruppe 1, i henhold til forskriften **EN 62471: 2008**  
**S** Riskgrupp 1, enligt standard **EN 62471: 2008**  
**RUS** GROUP РИСК 1 В СООТВЕТСТВИИ СО **EN 62471: 2008**

**CN** 风险组:1  
灯具和灯具系统的光生物学安全性符合标准 **EN 62471: 2008**

**iGuzzini**

2.509.216.00  
IS05718/01

استبدال الضوء LED  
SOSTITUZIONE DEL LED  
REPLACING THE LED  
REEMPLAZO DEL LED

تنبیه: لاستبدال الضوء LED اتصل بشركة iGuzzini .

I N.B.: Per la sostituzione del LED contattare l'azienda iGuzzini.

GB N.B.: For information on LED replacement please contact iGuzzini.

E NOTA: Para sustituir el LED llame a la empresa iGuzzini.

فئة الخطر 1 . حسب مقاييس EN 62471: 2008 .

I Gruppo di rischio 1, secondo norma EN 62471: 2008

GB Risk Group: 1, in compliance with Standard EN 62471: 2008

E Grupo de riesgo 1, según norma EN 62471: 2008

iGuzzini

2.509.216.00  
IS05718/01

استبدال الضوء LED  
SOSTITUZIONE DEL LED  
REPLACING THE LED  
REEMPLAZO DEL LED

تنبیه: لاستبدال الضوء LED اتصل بشركة iGuzzini .

I N.B.: Per la sostituzione del LED contattare l'azienda iGuzzini.

GB N.B.: For information on LED replacement please contact iGuzzini.

E NOTA: Para sustituir el LED llame a la empresa iGuzzini.

فئة الخطر 1 . حسب مقاييس EN 62471: 2008 .

I Gruppo di rischio 1, secondo norma EN 62471: 2008

GB Risk Group: 1, in compliance with Standard EN 62471: 2008

E Grupo de riesgo 1, según norma EN 62471: 2008

iGuzzini

2.509.216.00  
IS05718/01

استبدال الضوء LED  
SOSTITUZIONE DEL LED  
REPLACING THE LED  
REEMPLAZO DEL LED

تنبیه: لاستبدال الضوء LED اتصل بشركة iGuzzini .

I N.B.: Per la sostituzione del LED contattare l'azienda iGuzzini.

GB N.B.: For information on LED replacement please contact iGuzzini.

E NOTA: Para sustituir el LED llame a la empresa iGuzzini.

فئة الخطر 1 . حسب مقاييس EN 62471: 2008 .

I Gruppo di rischio 1, secondo norma EN 62471: 2008

GB Risk Group: 1, in compliance with Standard EN 62471: 2008

E Grupo de riesgo 1, según norma EN 62471: 2008

iGuzzini

2.509.216.00  
IS05718/01

استبدال الضوء LED  
SOSTITUZIONE DEL LED  
REPLACING THE LED  
REEMPLAZO DEL LED

تنبیه: لاستبدال الضوء LED اتصل بشركة iGuzzini .

I N.B.: Per la sostituzione del LED contattare l'azienda iGuzzini.

GB N.B.: For information on LED replacement please contact iGuzzini.

E NOTA: Para sustituir el LED llame a la empresa iGuzzini.

فئة الخطر 1 . حسب مقاييس EN 62471: 2008 .

I Gruppo di rischio 1, secondo norma EN 62471: 2008

GB Risk Group: 1, in compliance with Standard EN 62471: 2008

E Grupo de riesgo 1, según norma EN 62471: 2008

iGuzzini

2.509.216.00  
IS05718/01

استبدال الضوء LED  
SOSTITUZIONE DEL LED  
REPLACING THE LED  
REEMPLAZO DEL LED

تنبیه: لاستبدال الضوء LED اتصل بشركة iGuzzini .

I N.B.: Per la sostituzione del LED contattare l'azienda iGuzzini.

GB N.B.: For information on LED replacement please contact iGuzzini.

E NOTA: Para sustituir el LED llame a la empresa iGuzzini.

فئة الخطر 1 . حسب مقاييس EN 62471: 2008 .

I Gruppo di rischio 1, secondo norma EN 62471: 2008

GB Risk Group: 1, in compliance with Standard EN 62471: 2008

E Grupo de riesgo 1, según norma EN 62471: 2008

iGuzzini

- I Istruzioni per le operazioni di servizio per l'apparecchio di illuminazione**  
**GB Instructions on luminaire service operations**  
**F Instructions pour les opérations de service du luminaire**  
**D Wartungsanleitung für die Leuchte**  
**NL Instructies voor de onderhoudsoperaties op de verlichtingsarmatuur**  
**E Instrucciones para las operaciones de servicio del aparato de alumbrado**  
**DK Anvisninger i serviceindgreb på belysningsarmatur**  
**N Anvisninger for betjening av lysapparatet**  
**S Instruktioner för användning av belysningsanordningen**  
**RUS Инструкции по эксплуатации осветительного прибора**  
**CN 照明装置检修操作说明**

**Sostituire la lampada parzialmente esausta**  
 Replace the partly exhausted lamp  
 Remplacer la lampe partiellement épuisée  
 Die teilweise erschöpfte Lampe austauschen  
 Vervang de gedeeltelijk lege lamp  
 Sustituir la lámpara parzialmente agotada  
 Udskift den delvist udtjente pære  
 Skifte ut den delvis utbrente lyspæren  
 Byt ut den delvis förbrukade lampan  
 Замена частично отработанной лампочки  
 更换部分老化的灯泡



**Spegnimento**  
 Switch it off  
 Extinction  
 Ausschaltung  
 Uitschakeling  
 Apagado  
 Slukning  
 Slukking  
 Släckning  
 Выключение  
 关灯

**Interrompere l'alimentazione dell'apparecchio**  
 Cut the power supply to the luminaire  
 Couper l'alimentation du luminaire  
 Stromversorgung der Leuchte unterbrechen  
 Onderbreek de voeding van het apparaat  
 Interrumpir la alimentación del aparato  
 Afbryd armaturets strømforsyning  
 Avbryt strømtilførselen til apparatet  
 Koppla från anordningens strömförsörjning  
 Отключить электропитание прибора  
 中断装置供电



**Aprire l'apparecchio**  
 Open the fixture  
 Ouvrir le luminaire  
 Das Gerät öffnen  
 Open het apparaat  
 Abrir el aparato  
 Åbn armaturet  
 Åpne apparatet  
 Öppna anordningen  
 Раскрыть прибор  
 打开装置

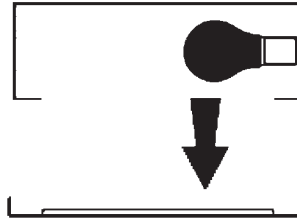

**Rimuovere la lampada esausta**  
 Remove the exhausted lamp  
 Retirer la lampe épuisée  
 Die alte Lampe entnehmen  
 Verwijder de lege lamp  
 Quitar la lámpara agotada  
 Tag den udtjente pære ud  
 Fjerne den utbrente lyspæren  
 Ta bort den förbrukade lampan  
 Вынуть старую лампочку  
 取出老化的灯泡

**Portarla in un centro di riciclaggio**  
 Carry it to a recycling centre  
 La porter dans une déchetterie pour son recyclage  
 Ordnungsgemäß entsorgen  
 Breng de lamp naar een recyclingcentrum  
 Llevarla a un centro de reciclaje  
 Aflever den på en genbrugsstation  
 Lever den til en miljøstasjon  
 Lämna in den till en återvinningsanläggning  
 Сдать ее в пункт приема утильсырья  
 将其送往回收中心

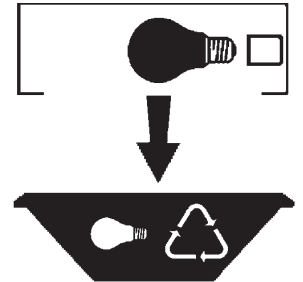

**Inserire la nuova lampada**  
 Introduce the new lamp  
 Installer la lampe neuve  
 Die neue Lampe einsetzen  
 Doe de nieuwe lamp op zijn plek  
 Montar la nueva lámpara  
 Sæt den nye pære i  
 Sette i den nye pæren  
 Sätt i den nya lampan  
 Вставить новую лампочку  
 装入新灯泡

**Inserire la nuova lampada nel portalampada**  
 Fit the new lamp into the socket  
 Installer la nouvelle lampe dans le support de lampe  
 Die neue Lampe in den Sockel einsetzen  
 Doe de nieuwe lamp in de lamphouder  
 Montar la nueva lámpara en el portalámpara  
 Sæt den nye pære i fatningen  
 Sette den nye pæren inn i lampeholderen  
 Sätt i den nya lampan i lamphållaren  
 Вставить новую лампочку в патрон  
 将新灯泡插入灯泡架中



**Riposizionare ottica**  
 Re-place the optic  
 Remettre l'optique à sa place  
 Die Optik wieder einsetzen  
 Doe de optiek weer op zijn plaats  
 Volver a montar la óptica  
 Sæt den optiske enhed på plads  
 Innstille linsen  
 Flytta om optiken  
 Отрегулировать линзы  
 重新定位光头



**Effettuare prova di funzionamento**  
 Perform operative test  
 Procéder à un essai de fonctionnement  
 Eine Funktionsprüfung durchführen  
 Controleer de correcte werking  
 Hacer una prueba de funcionamiento  
 Afprøv funktionen  
 Prøve om den fungerer  
 Utför funktionstest  
 Выполнить проверку исправности работы  
 执行功能测试

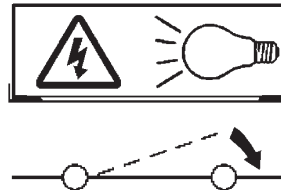

**I Istruzioni per la pulizia dell'apparecchio di illuminazione**  
**GB Instructions on luminaire cleaning operations**  
**F Instructions pour le nettoyage du luminaire**  
**D Anweisungen zur Reinigung der Leuchte**  
**NL Instructies voor de reiniging van de verlichtingsarmatuur**  
**E Instrucciones para limpiar el aparato de alumbrado**  
**DK Anvisninger i rengøring af belysningsarmaturet**  
**N Anvisninger for rengjøring av lysapparatet**  
**S Instruktioner för rengöring av belysningsanordningen**  
**RUS Инструкции по чистке осветительного прибора**  
**CN 照明装置清洁说明**

**Pulire l'apparecchio**  
**Clean the fixture**  
**Nettoyer le luminaire**  
**Das Gerät reinigen**  
**Reinig het apparaat**  
**Limpiar el aparato**  
**Rengør armaturet**  
**Rengjøre apparatet**  
**Rengör anordningen**  
**Чистка прибора**  
**清洁装置**

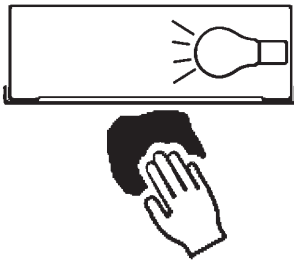

**Spegnimento**  
**Switch it off**  
**Extinction**  
**Ausschaltung**  
**Uitschakeling**  
**Apagado**  
**Slukning**  
**Slukking**  
**Släckning**  
**Выключение**  
**关灯**

**Interrompere l'alimentazione dell'apparecchio**  
**Cut the power supply to the luminaire**  
**Couper l'alimentation du luminaire**  
**Stromversorgung der Leuchte unterbrechen**  
**Onderbreek de voeding van het apparaat**  
**Interrumpir la alimentación del aparato**  
**Afbryd armaturets strømforstyrning**  
**Avbryt strømtilførselen til apparatet**  
**Koppla från anordningens strömförsörjning**  
**Отключить электропитание прибора**  
**中断装置供电**



**Spolverare l'ottica esterna**  
**Remove dust from the external optic**  
**Dépoussiérer l'optique extérieure**  
**Die externe Optik abstauben**  
**Stof de externe optiek af**  
**Quitar el polvo de la óptica exterior**  
**Tør støvet af den udvendige optiske enhed**  
**Fjerne støv fra den eksterne lysenheden**  
**Damma av den yttre optiken**  
**Вытереть пыль с внешней стороны линз**  
**为外侧光头掸尘**

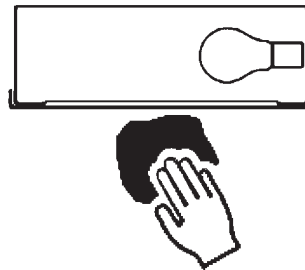

**Lavare l'ottica esterna**  
**Wash the external optic**  
**Laver l'optique extérieure**  
**Die externe Optik waschen**  
**Was de externe optiek**  
**Lavar la óptica exterior**  
**Vask den udvendige optiske enhed**  
**Vaske den eksterne lysenheden**  
**Rengör den yttre optiken**  
**Вымыть линзы с внешней стороны**  
**清洁外光头**

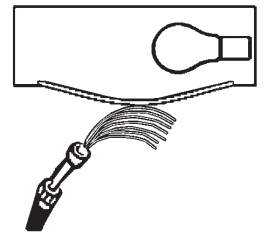

**Rimuovere l'ottica**  
**Remove the optic**  
**Retirer l'optique**  
**Die Optik abnehmen**  
**Verwijder de optiek**  
**Quitar la óptica**  
**Tag den optiske enhed af**  
**Fjerne lysenheden**  
**Ta bort optiken**  
**Снять линзы**  
**取下光头**

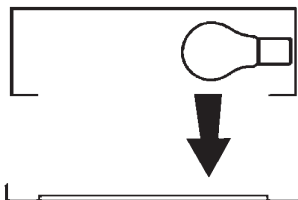

**Pulire la parte interna dell'apparecchio di illuminazione**  
**Clean the inside of the fixture**  
**Nettoyer l'intérieur du luminaire**  
**Die Innenseite der Leuchte reinigen**  
**Reinig de binnenzijde van de verlichtingsarmatuur**  
**Limpiar el interior del aparato de alumbrado**  
**Rengør belysningsarmaturets indvendige dele**  
**Rengjøre lysapparatet innvendig**  
**Rengör belysningsanordningen invändigt**  
**Протереть осветительный прибор изнутри**  
**清洁照明装置内部**



**Riposizionare ottica**  
**Re-place the optic**  
**Remettre l'optique à sa place**  
**Die Optik wieder einsetzen**  
**Doe de optiek weer op zijn plaats**  
**Volver a montar la óptica**  
**Sæt den optiske enhed på plads**  
**Innstille linsen**  
**Flytta om optiken**  
**Отрегулировать линзы**  
**重新定位光头**

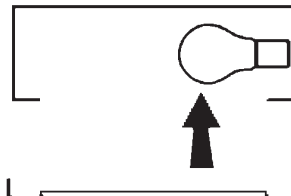

**Effettuare prova di funzionamento**  
**Perform operative test**  
**Procéder à un essai de fonctionnement**  
**Eine Funktionsprüfung durchführen**  
**Controleer de correcte werking**  
**Hacer una prueba de funcionamiento**  
**Afprøv funktionen**  
**Prøve om den fungerer**  
**Utför funktionstest**  
**Выполнить проверку исправности работы**  
**执行功能测试**



- I** Istruzioni per il fine vita e lo smaltimento dei componenti  
**GB** Instructions on end-of-life and component disposal  
**F** Instructions pour la gestion des composants en fin de vie et leur mise au rebut  
**D** Anweisungen zur Entsorgung der Leuchtenkomponenten  
**NL** Instructies voor het verwijderen van de armatuur en het recyclen van de onderdelen  
**E** Instrucciones para el final de vida y la eliminación los componentes  
**DK** Anvisninger i udtjent armatur og bortskaffelse af komponenter  
**N** Anvisninger for endt levetid og avfallsbehandling av delene  
**S** Instruktioner vid bortskaffning och kassering av komponenter  
**RUS** Инструкции по утилизации прибора и его комплектующих по окончании его срока службы  
**CN** 寿命期结束与零件废弃处置说明

<p>Spegnimento Switch it off Extinction Ausschaltung Uitschakeling Apagado Slukning Slukking Släckning Выключение 关灯</p> <p>Interrompere l'alimentazione dell'apparecchio Cut the power supply to the luminaire Couper l'alimentation du luminaire Stromversorgung der Leuchte unterbrechen Onderbreek de voeding van het apparaat Interrompirla alimentación del aparato Afbryd armaturets strømforsyning Avbryt strømtilførselen til apparatet Koppla från anordningens strömförsörjning Отключить электропитание прибора 中断装置供电</p> 	<p>Rimuovere la/e lampada/e per la dismissione Remove the lamp(s) for decommissioning Retirer la(les) lampe(s) pour sa(leur) mise au rebut Die Lampe/n ordnungsgemäß entsorgen Verwijder de lamp(en) voor het recyclen Quitar la(s) lámpara(s) para el desecho Tag pæren/pærerne ud til bortskaffelse Fjerne lampen/-e som skal kastes Ta bort lampan/-orna för bortskaffningen Вынуть лампочку/и для утилизации прибора 取出需要丢弃的灯泡</p> 	<p>Rimuovere la batteria per la dismissione Remove the battery for decommissioning Retirer la batterie pour sa mise au rebut Die Batterie ordnungsgemäß entsorgen Verwijder de batterij voor het recyclen Quitar la batería para el desecho Tag batteriet ud til bortskaffelse Fjerne batteriet som skal kastes Ta bort batteriet för bortskaffningen Вынуть батарейку для утилизации прибора 取出需要丢弃的电池</p> 	<p>Rimuovere l'apparecchio per la dismissione Remove the fixture for decommissioning Enlever le luminaire pour sa mise au rebut Das Gerät ordnungsgemäß entsorgen Verwijder het apparaat voor het recyclen Quitar el aparato para el desecho Tag armaturet ud til bortskaffelse Fjerne apparatet som skal kastes Ta bort anordningen för bortskaffningen Снять прибор для утилизации 取出需要丢弃的装置</p> 
---	--	--	--

<p>Inviare i materiali ad un centro di raccolta RAEE Send the materials to a WEEE collection centre Envoyer les matériaux dans une déchetterie DEEE Die Materialien in einem WEEE-Zentrum entsorgen Zend de materialen naar een recyclingscentrum voor de AEEA Enviar los materiales a un centro de recogida RAEE Afløver materialerne på et indsamlingscenter for elektronisk udstyr Sende materialene til en miljøstasjon for resirkulering av EE-avfall Skicka materialet till en RAEE uppsamlingscentral Сдать материалы в пункт приема утильсырья 将材料送往电气和电子垃圾回收中心</p> 			
--	--	--	--