

IPRO LED (MICRO)

ATTENZIONE:

LA SICUREZZA DELL'APPARECCHIO E' GARANTITA SOLO CON L'USO APPROPRIATO DELLE SEGUENTI ISTRUZIONI; PERTANTO E' NECESSARIO CONSERVARLE.

GB WARNING:

THE SAFETY OF THIS FIXTURE IS GUARANTEED ONLY IF YOU COMPLY WITH THESE INSTRUCTIONS; REMEMBER TO CONSERVE IN A SAFE PLACE.

F ATTENTION:

LA SECURITE DE L'APPAREIL N'EST GARANTIE QU'EN CAS D'UTILISATION CORRECTE DES INSTRUCTIONS SUIVANTES; IL FAUT PAR CONSEQUENT LES CONSERVER.

D ACHTUNG:

DIE SICHERHEIT DES GERÄTES WIRD NUR DURCH SACHGEMÄSSE BEFOLGUNG NACHSTEHENDER ANWEISUNGEN GEWÄHRLEISTET; IHRE AUFBEWAHRUNG IST DESHALB SEHR WICHTIG.

NL OPGELET:

DE VEILIGHEID VAN DI ATOESTEL IS SLECHTS DAN GEGARANDEERD ALS INDIEN DE VOLGENDE INSTRUCTIES STRIKT WORDEN TOEGEPAST: DAAROM MOET MEN ZE OOK BEWAREN.

E ATENCION:

LA SEGURIDAD DEL APARATO SE GARANTIZA SOLO CUMPLIENDO CUIDADOSAMENTE LAS SIGUIENTES INSTRUCCIONES; POR ELLO, ES NECESARIO CONSERVARLAS.

DK BEMÆRK:

SIKKERHEDEN VED BRUG AF ARMATURET KAN KUN GARANTERES, HVIS DISSE ANVISNINGER FØLGES; SØRG DERFOR FOR AT GEMME DEM.

N ADVARSEL:

SIKKERHETEN TIL DETTE APPARATET GARANTERES KUN HVIS DU OVERHOLDER DISSE INSTRUKSJONENE; HUSK Å OPPBEVARE DEM PÅ ET TRYGT STED.

S OBSERVERA!

UTRUSTNINGENS SÄKERHET KAN ENDAST GARANTERAS OM DESSA ANVISNINGAR RESPEKTERAS I DETALJ. SPARA DÄRFÖR DESSA ANVISNINGAR FÖR FRAMTIDA KONSULTATION.

RUS ВНИМАНИЕ:

МЫ ГАРАНТИРУЕМ БЕЗОПАСНУЮ ЭКСПЛУАТАЦИЮ ИЗДЕЛИЯ ТОЛЬКО ПРИ СОБЛЮДЕНИИ СЛЕДУЮЩИХ ИНСТРУКЦИЙ; С ЭТОЙ ЦЕЛЬЮ НЕОБХОДИМО СОХРАНИТЬ ДАННУЮ БРОШЮРУ.

CN 警告

为确保该装置安全, 请遵守操作指示; 并于安全场所放置。

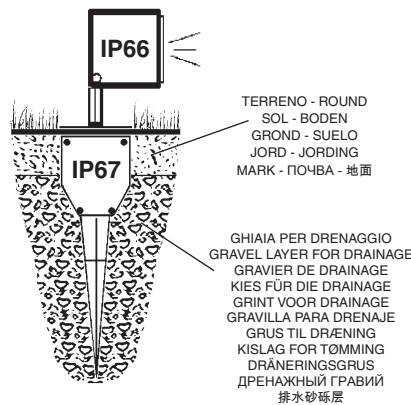
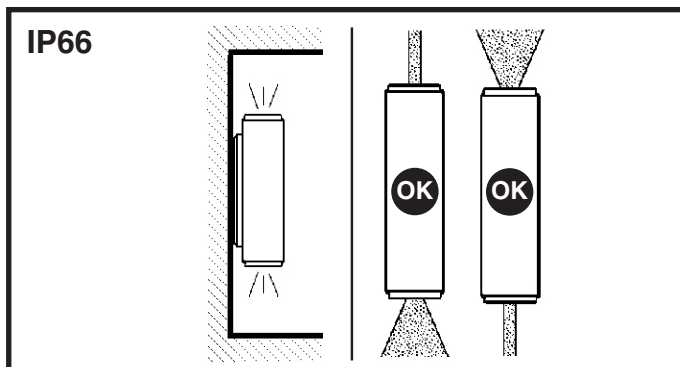
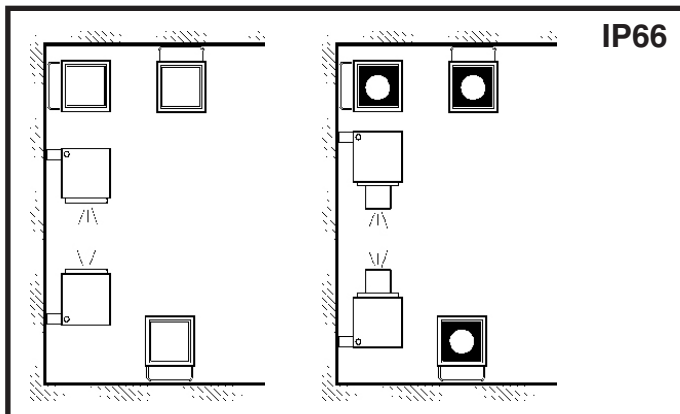
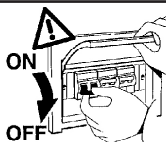

DIMENSIONI, PESO E SUPERFICIE DI MASSIMO INGOMBRO, DELLA COMPOSIZIONE COMPLETA DI ACCESSORI.

MAXIMUM SIZE, WEIGHT AND AREA OF THE COMPOSITION COMPLETE WITH AND ACCESSORIES.

DIMENSIONS, POIDS ET SURFACE MAXIMUM D'ENCOMBREMENT DE LA COMPOSITION AVEC ACCESSOIRES.

ABMESSUNGEN, GEWICHT UND GRÖßTE FLÄCHE FÜR DIE KOMPLETT MIT ZUBEHÖR KOMPOSITION.

MAXIMUM AFMETINGEN, GEWICHT EN OPPERVLAKTE VAN DE COMPOSITIE, COMPLEET MET ACCESSOIRES.

DIMENSIONES, PESO Y SUPERFICIE MAXIMA DE OCUPACION, DEL CNJUNTO EQUIPADO CON ACCESORIOS.

MAKS. MÅL, VÆGT OG OVERFLADE AF DEN SAMLEDE INSTALLATION INKL. TILBEHØR.

MAKSIMAL STØRRELSE, VEKT OG OMRÅDE PÅ SAMMENSETNINGEN MED TILBEHØR.

MÅTT, VIKT OCH MAX. YTTRE MÅTT FÖR UTFÖRANDET FÖRSETT MED TILLBEHÖR.

РАЗМЕРЫ, ВЕС И МАКСИМАЛЬНО ЗАНИМАЕМАЯ ПЛОЩАДЬ КОНСТРУКЦИИ, УКОМПЛЕКТОВАННОЙ ВСПОМОГАТЕЛЬНЫМИ УСТРОЙСТВАМИ.

合成物最大尺寸、重量和面积, 包括附件。

ART.	PESO WEIGHT POIDS GEWICHT GEWICHT PESO VÆGT VEKT VIKT BEC 重量 (Kg)	Dimensioni - Dimensions Dimensions - Abmessungen Afmetingen - Dimensiones - Mål - Mål - Mått Размеры 尺寸 b x h (m)	Superficie - Surface Surface - Oberfläche Oppervlak - Superficie Overflade - Overflate Yta Поверхность 面积 (mq)
BJ88 - BJ89 BJ90 - BJ91 BJ92 - BJ93 BJ94 - BJ95 BJ96 - BJ97 BJ98 - BJ99 BK00 - BK01 BK02 - BK03 BK04 - BK05 BK06 - BK07 BK08 - BK09 BK10 - BK11 BK12 - BK13 BK14 - BK15 BK16 - BK17	0,260	0,05 x 0,05	0,003

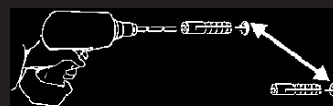

art. BJ88 - BJ89 - BJ90 - BJ91
BJ92 - BJ93 - BJ94 - BJ95
BJ96 - BJ97 - BJ98
BJ99 - BK00 - BK01

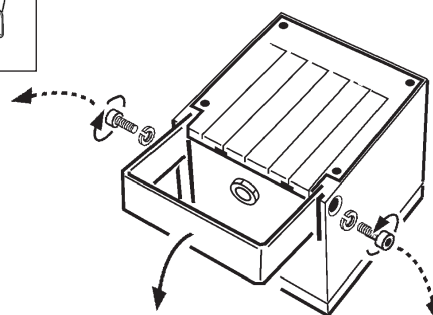

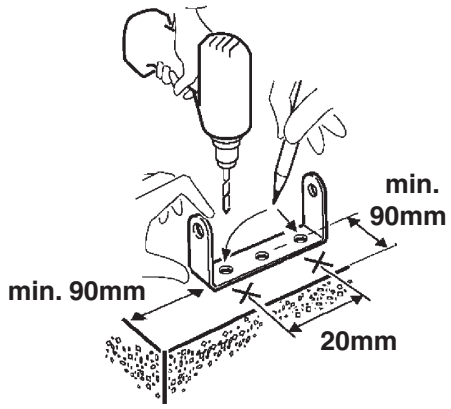

Ø2,9-3,5mm

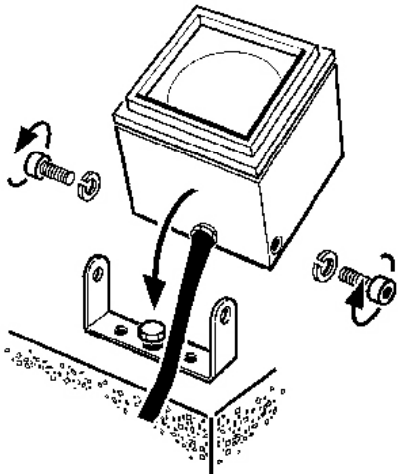
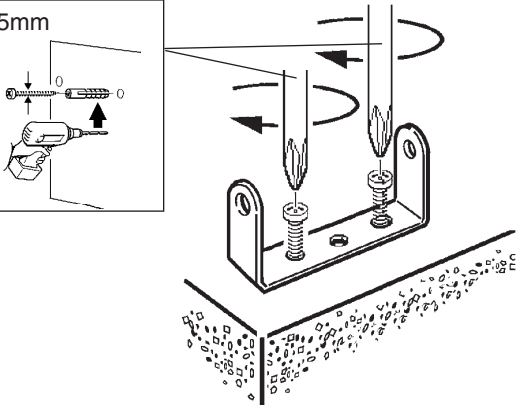

art. BK08 - BK09 - BK10
BK11 - BK12 - BK13

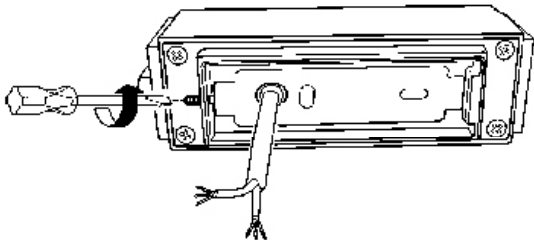

15mm 48mm

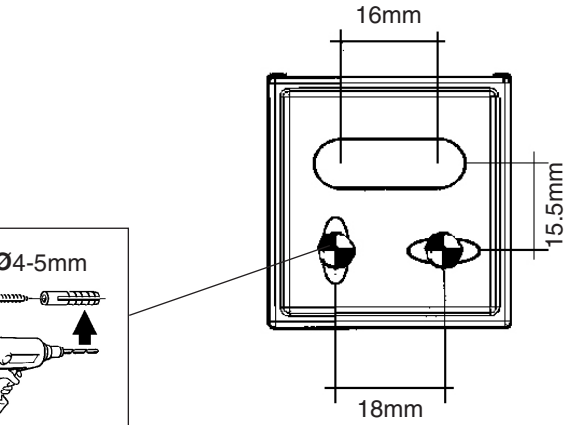
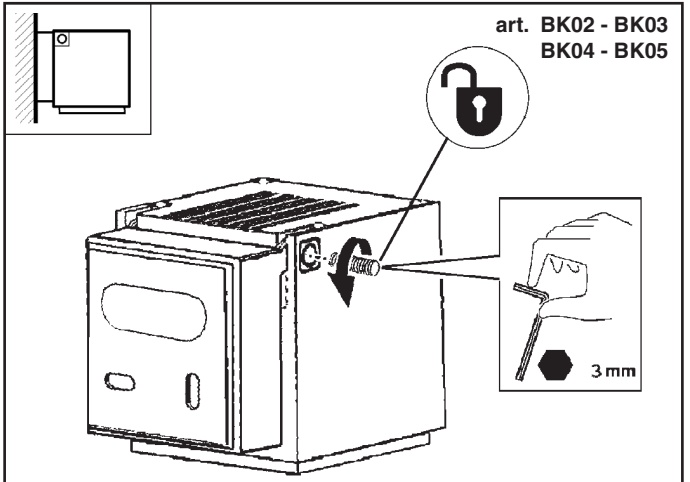
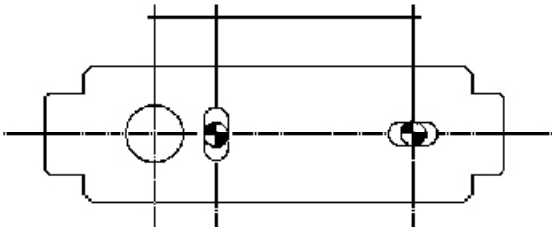

art. BK06
BK07

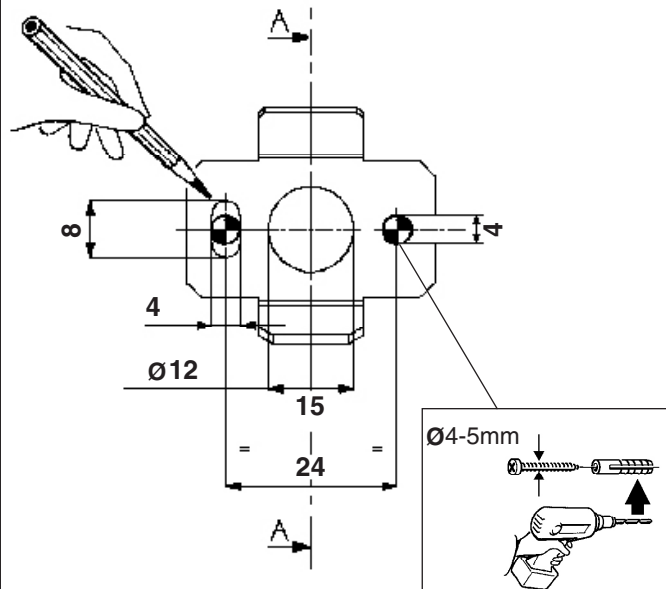
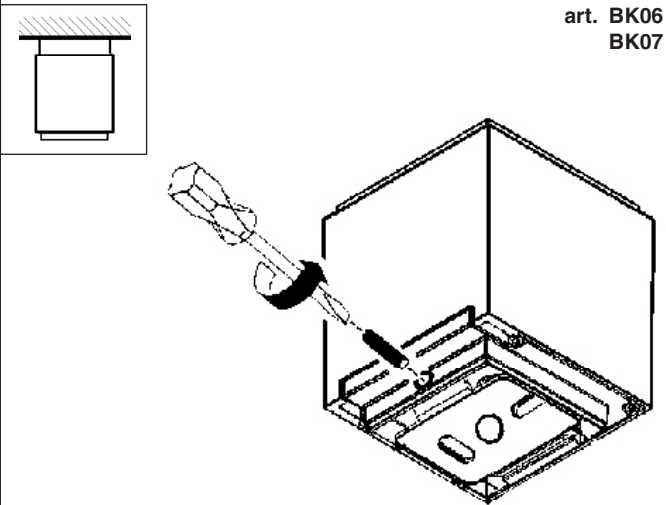

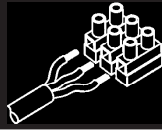

500 mA

art. BJ88 - BJ89 - BJ94
BJ95 - BJ96 - BJ97
BJ98 - BJ99

500 mA
700 mA

art. BJ90 - BJ91 - BJ92
BJ93 - BK00 - BK01

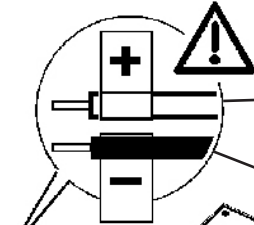

MARRONE BRUN
BROWN BRUN
MARRON BRUN
BRAUN КОРИЧНЕВЫЙ
BRUIN 棕色
MARRÓN

BLU BLÀ
BLUE BLÀ
BLEU BLÀ
BLAU СИНИЙ
BLAUW 蓝色
AZUL

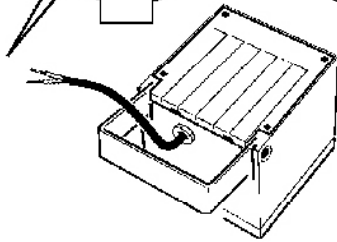

art. BK08 - BK09 - BK10
BK11 - BK12 - BK13

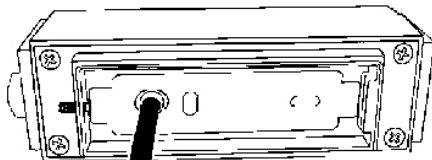

220/240V

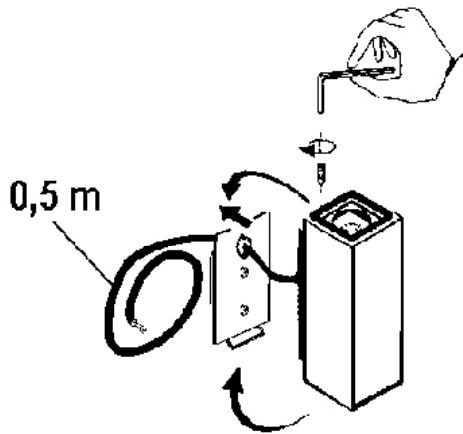
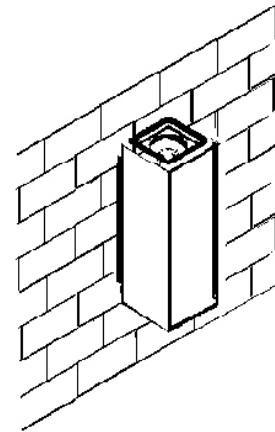
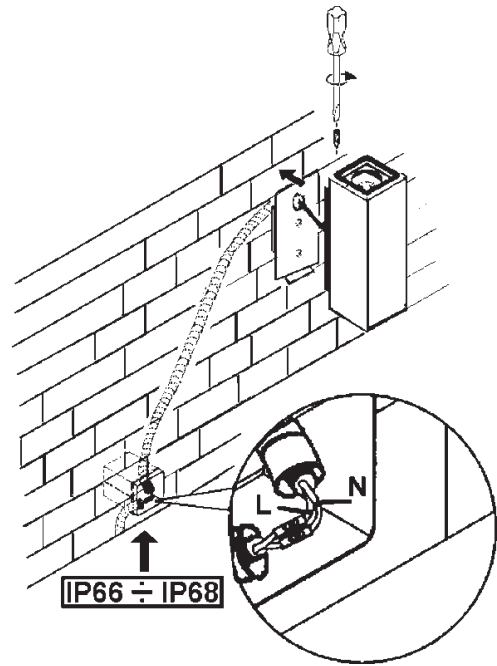
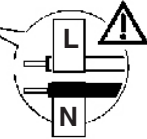

0,5 m

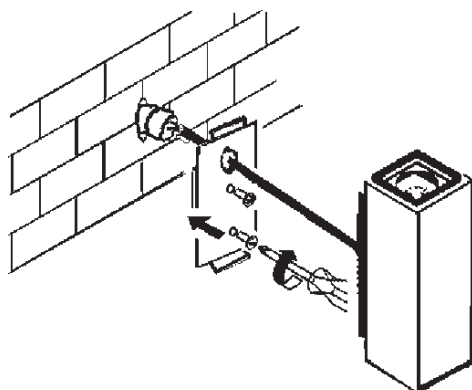

500 mA

art. BK02 - BK03
BK06 - BK07

500 mA
700 mA

art. BK04 - BK05

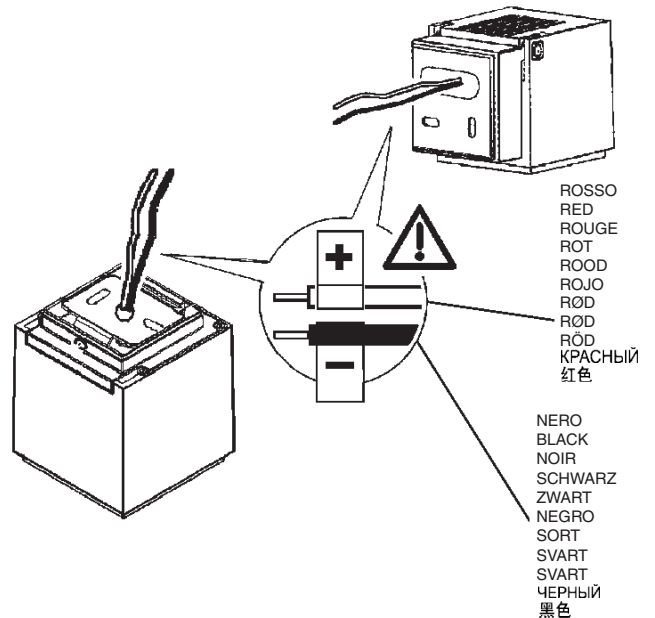

ROSSO
RED
ROUGE
ROT
ROOD
ROJO
RØD
RØD
RØD
КРАСНЫЙ
红色

NERO
BLACK
NOIR
SCHWARZ
ZWART
NEGRO
SORT
SVART
SVART
ЧЕРНЫЙ
黑色

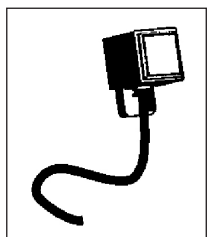
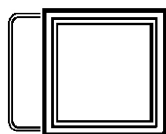

art.9582

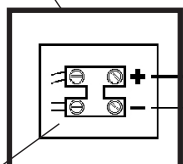

ALIMENTATORE
 BALLAST
 BALLAST
 VORSCHALTGERÄT
 VOORSCHAKELAPPARAAT
 ALIMENTADOR
 STRØMFORSYNINGSENHED
 BALLAST
 STRØMFORSYNINGSA-
 NORDNING
 БЛОК ПИТАНИЯ
 电源
 art.
 BZ98 (6W)
 BZ99 (12W)
 BZA0 (20W)
 MXF9 (17W)

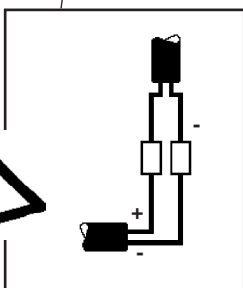

MARRONE - BROWN
 MARRON - BRAUN
 BRUIN - MARRÓN
 BRUN - BRUN
 BRUN - КОРИЧНЕВЫЙ
 棕色 (+)

BLU - BLUE
 BLEU - BLAU
 BLAUW - AZUL
 BLÁ - BLÁ
 BLÁ - СИНИЙ
 蓝色 (-)

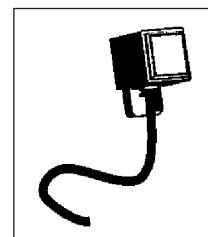
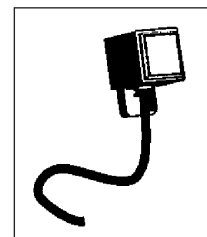
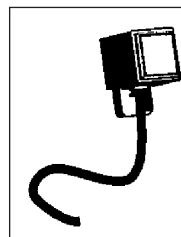
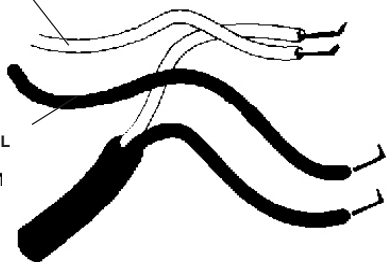

art.9582

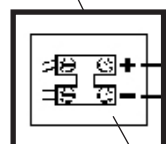

ALIMENTATORE
 BALLAST
 BALLAST
 VORSCHALTGERÄT
 VOORSCHAKELAPPARAAT
 ALIMENTADOR
 STRØMFORSYNINGSENHED
 BALLAST
 STRØMFORSYNINGSA-
 NORDNING
 БЛОК ПИТАНИЯ
 电源
 art.
 BZ98 (6W)
 BZ99 (12W)
 BZA0 (20W)
 MXF9 (17W)

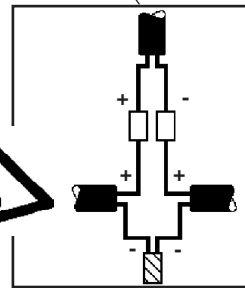

MARRONE - BROWN
 MARRON - BRAUN
 BRUIN - MARRÓN
 BRUN - BRUN
 BRUN - КОРИЧНЕВЫЙ
 棕色 (+)

BLU - BLUE
 BLEU - BLAU
 BLAUW - AZUL
 BLÁ - BLÁ
 BLÁ - СИНИЙ
 蓝色 (-)

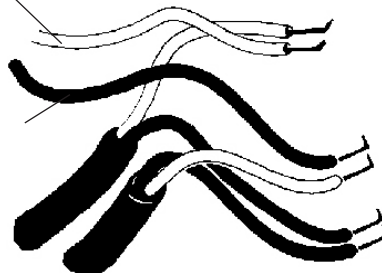

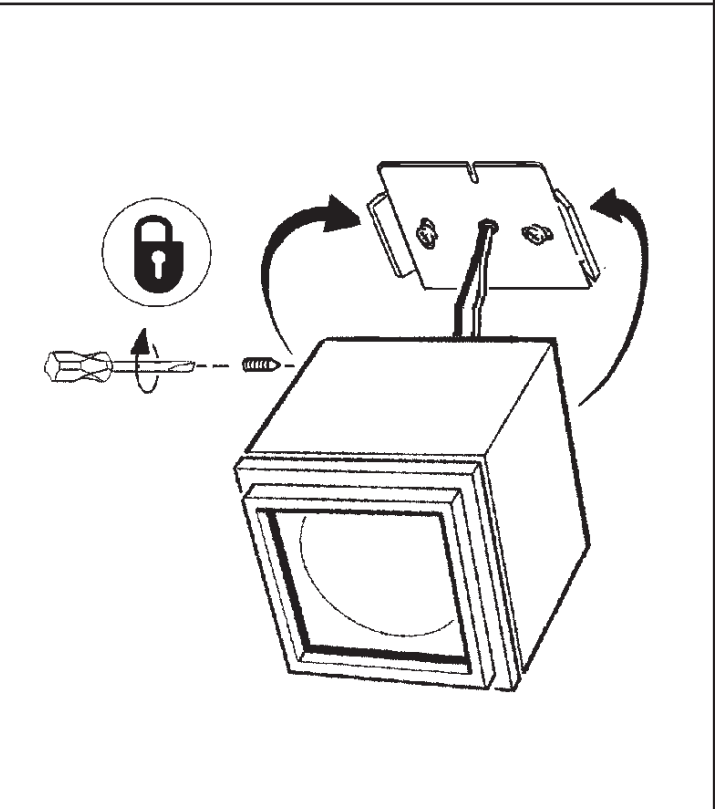
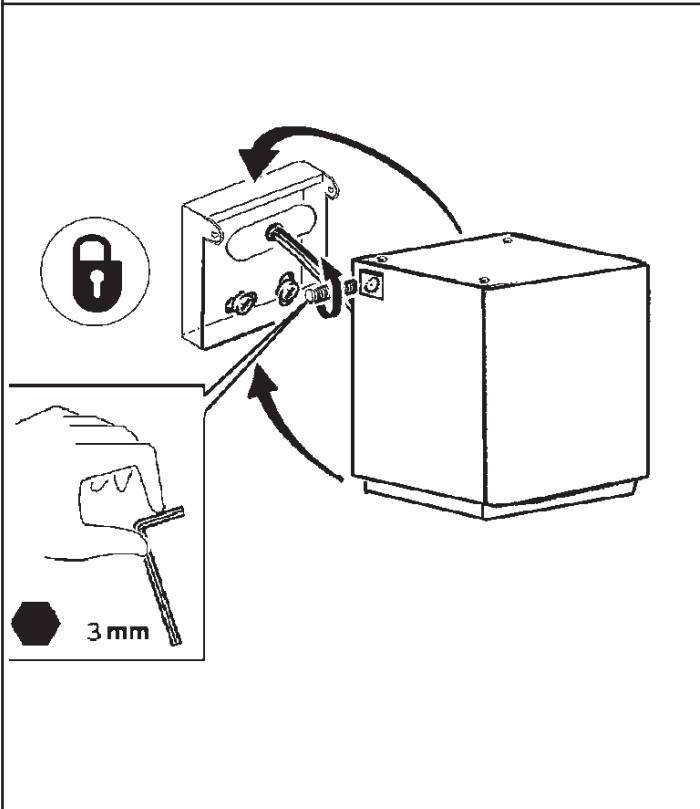
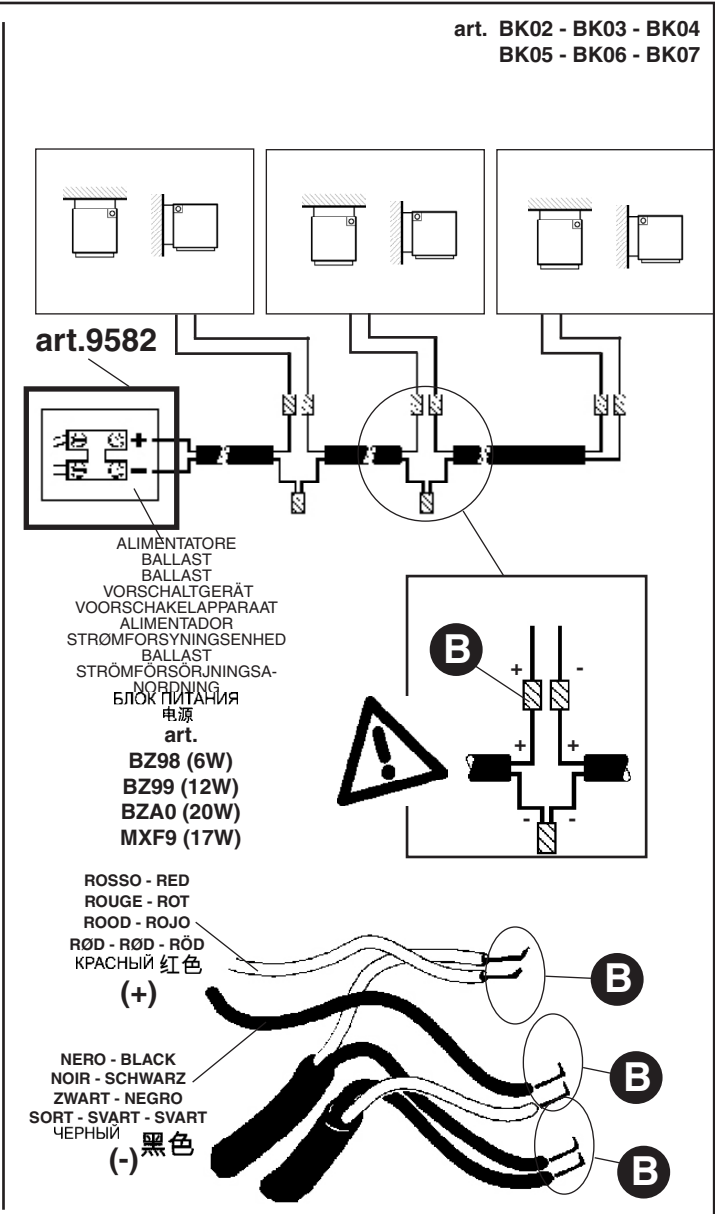
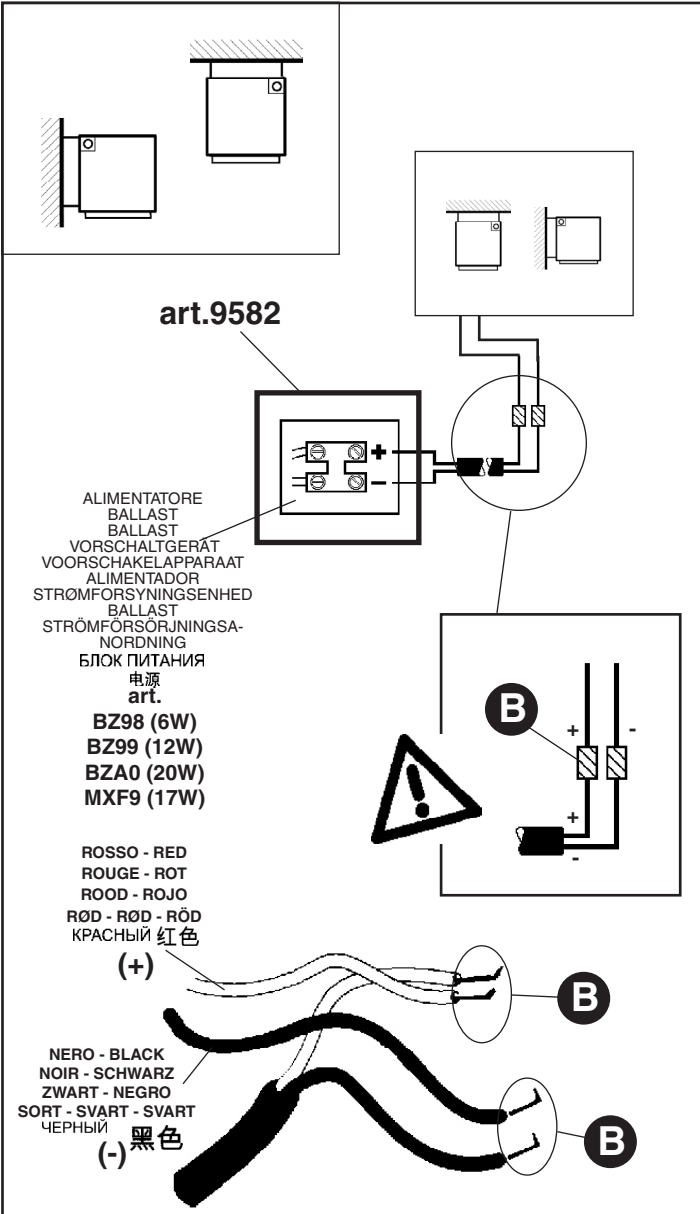

art. 9581

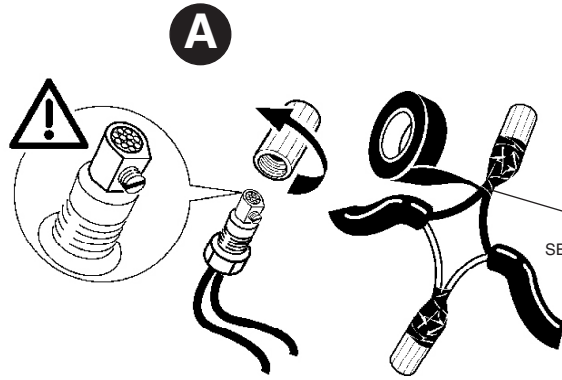
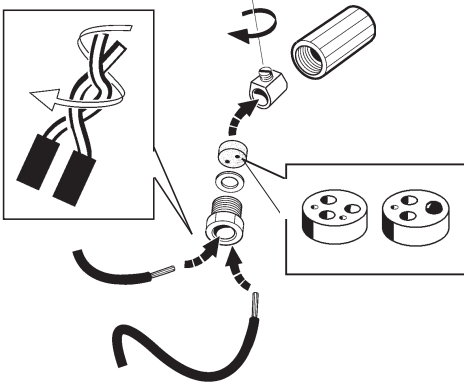

NASTRO AUTOAGGLOMERANTE
 SELF-VULCANISING TAPE
 RUBAN AUTO-SOUDABLE
 SELBSTHAFTBAND - (Klebefilm SCOTCH 23 3M)
 ZELFFUSERENDE TAPE
 CINTA AUTOAGLOMERANTE
 (SCOTCH 23 3M)
 SELVKLÆBENDE BÅND
 SELVVULKANISERENDE TAPE
 SJÄLVBINDANDE BAND
 САМОПЛАСТИФИЦИРУЮЩАЯ ЛЕНТА
 自硫化带

STAGNARE - COAT WITH TIN
 ETAMER - VERZINNEN
 -VERTINNEN - ESTANAR -
 FORSEGLE - LÖD
 ЛУЖЕНЫЕ 锡焊

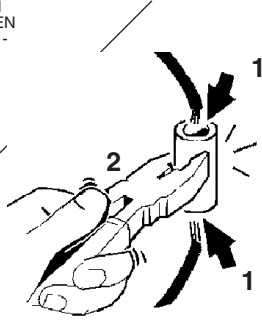

B

NASTRO AUTOAGGLOMERANTE
 SELF-VULCANISING TAPE
 RUBAN AUTO-SOUDABLE
 SELBSTHAFTBAND - (Klebefilm
 SCOTCH 23 3M)
 ZELFFUSERENDE TAPE
 CINTA AUTOAGLOMERANTE
 (SCOTCH 23 3M)
 SELVKLÆBENDE BÅND
 SELVVULKANISERENDE TAPE
 SJÄLVBINDANDE BAND
 САМОПЛАСТИФИЦИРУЮЩАЯ ЛЕНТА
 自硫化带

art. BZK7

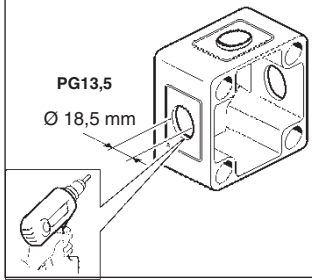
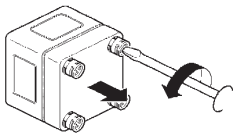

ALIMENTAZIONE
 POWER SUPPLY
 ALIMENTATION
 ZUFUHR
 VOEDING
 ALIMENTACION
 STRÖMFORSYNING
 STRÖMFORSYNING
 ELFÖRSÖRJNING
 ЭЛЕКТРОПИТАНИЕ
 电源

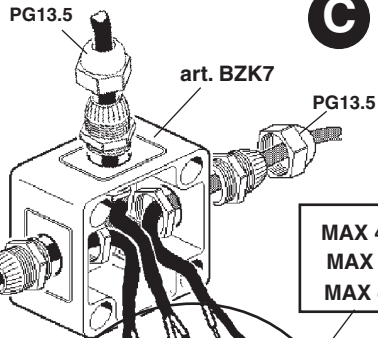

MAX 4 mm
 MAX 32 A
 MAX 400V

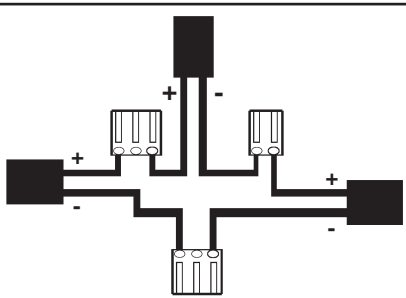
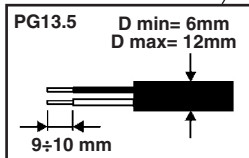

art. BZK6

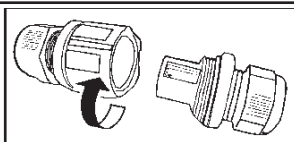
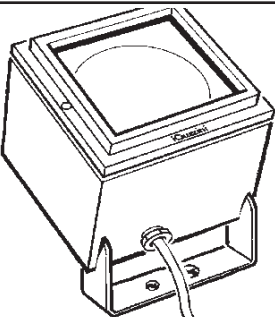

D



MAX 2,5 mm²

D (mm)	
6,5 ÷ 8 mm	
8 ÷ 9 mm	
9 ÷ 13 mm	

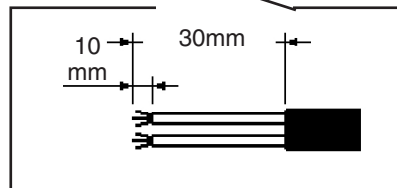
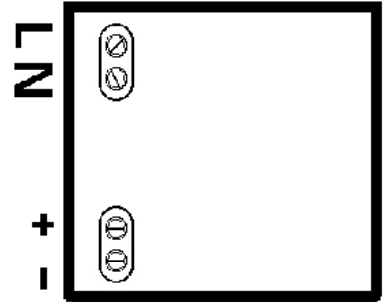
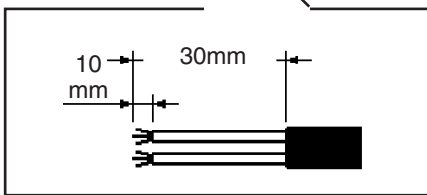
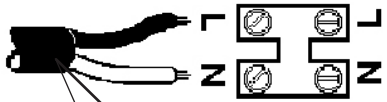
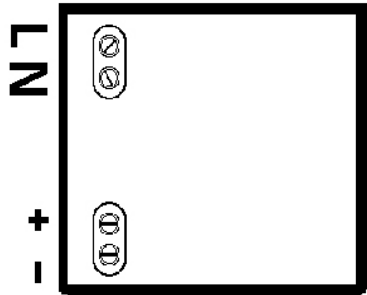
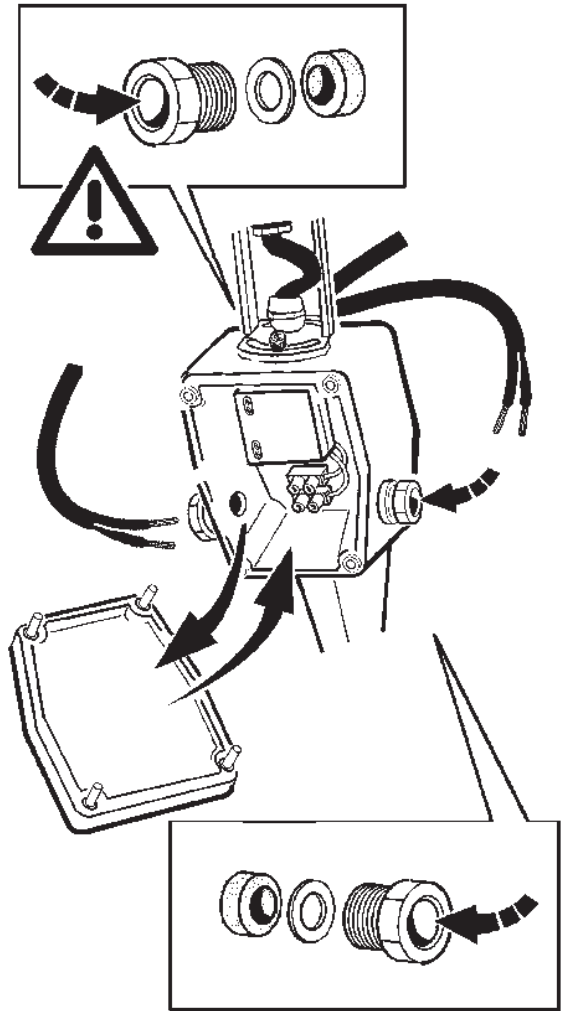
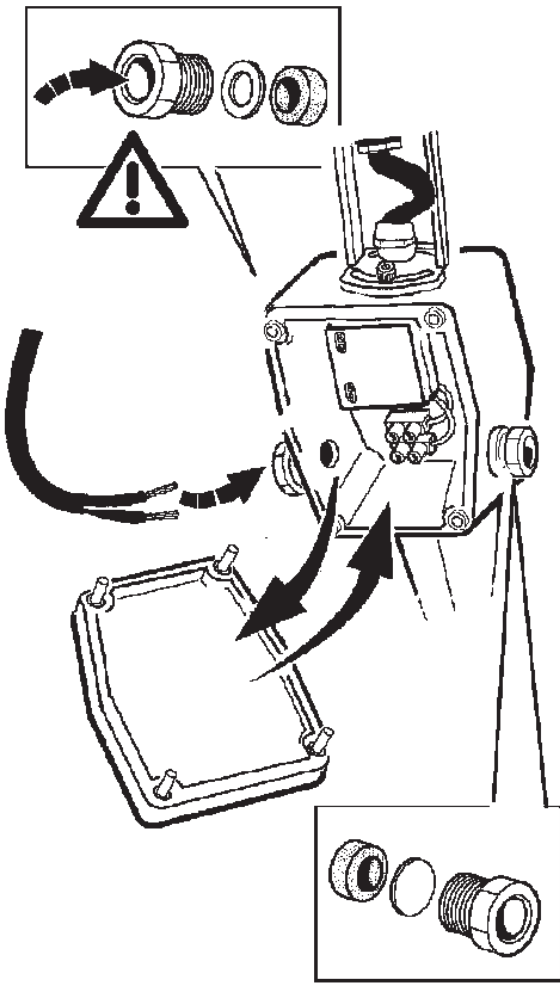

ART.	fattore di potenza power factor facteur de puissance Leistungsfaktor vermogensfactor factor de potencia effektfaktor effektfaktor effektfaktor фактор мощности 功率因数	corrente assorbita absorbed current courant absorbé Stromaufnahme stroomopname corriente absorbida absorberet strøm absorberet strøm tillförd ström поглщаемая мощность 电源电流 (A)
BK08 - BK09 BK10 - BK11 BK12 - BK13 BK14 - BK15 BK16 - BK17	0,35	0,08

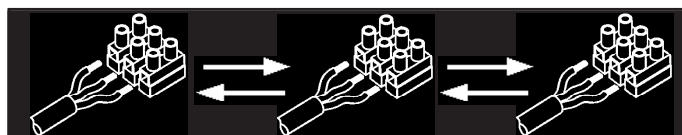

ART.	(W)	Sezione Section Section Querschnitt Doorsnede Sección Snit Avsnitt Tvärsnitt ЛАМПА 安装区域 mm ²	ALIMENTATORE BALLAST BALLAST VORSCHALTGERÄT VOORSCHAKELAPARAAT ALIMENTADOR STRÖMFÖRSYNINGSENHED BALLAST STRÖMFÖRSYNINGSANORDNING БЛОК ПИТАНИЯ 电源	<table border="1"> <tr> <th colspan="2">art. BZ98 (6W) 500 mA</th> <th colspan="2">art. BZ99 (12W) 500 mA</th> <th colspan="2">art. BZA0 (500 mA)</th> <th colspan="2">art. MXF9 (17W) 700 mA</th> </tr> <tr> <th>max N°</th> <th>L (m)</th> <th>max N°</th> <th>L (m)</th> <th>max N°</th> <th>L (m)</th> <th>max N°</th> <th>L (m)</th> </tr> </table>	art. BZ98 (6W) 500 mA		art. BZ99 (12W) 500 mA		art. BZA0 (500 mA)		art. MXF9 (17W) 700 mA		max N°	L (m)	max N°	L (m)	max N°	L (m)	max N°	L (m)																																					
art. BZ98 (6W) 500 mA		art. BZ99 (12W) 500 mA		art. BZA0 (500 mA)		art. MXF9 (17W) 700 mA																																																			
max N°	L (m)	max N°	L (m)	max N°	L (m)	max N°	L (m)																																																		
BJ90 - BJ91 BJ92 - BJ93 BK00 - BK01 BK04 - BK05	1,6 ÷ 2,2	1,5 mm ² 2,5mm ² 4 mm ²	/ / /	/ / /	/ / /	7 7 7	54 90 135																																																		
BJ88 - BJ89 BJ94 - BJ95 BJ96 - BJ97 BJ98 - BJ99 BK06 - BK07 BK02 - BK03	4,8	1,5 mm ² 2,5 mm ² 4 mm ²	<table border="1"> <tr> <td>1</td><td>110</td><td>2</td><td>221</td><td>3</td><td>300</td><td>/</td> </tr> <tr> <td>1</td><td>184</td><td>2</td><td>368</td><td>3</td><td>510</td><td>/</td> </tr> <tr> <td>1</td><td>276</td><td>2</td><td>553</td><td>3</td><td>750</td><td>/</td> </tr> </table>	1	110	2	221	3	300	/	1	184	2	368	3	510	/	1	276	2	553	3	750	/	<table border="1"> <tr> <td>2</td><td>221</td><td>3</td><td>300</td><td>/</td> </tr> <tr> <td>2</td><td>368</td><td>3</td><td>510</td><td>/</td> </tr> <tr> <td>2</td><td>553</td><td>3</td><td>750</td><td>/</td> </tr> </table>	2	221	3	300	/	2	368	3	510	/	2	553	3	750	/	<table border="1"> <tr> <td>3</td><td>300</td><td>/</td> </tr> <tr> <td>3</td><td>510</td><td>/</td> </tr> <tr> <td>3</td><td>750</td><td>/</td> </tr> </table>	3	300	/	3	510	/	3	750	/	<table border="1"> <tr> <td>7</td><td>54</td> </tr> <tr> <td>7</td><td>90</td> </tr> <tr> <td>7</td><td>135</td> </tr> </table>	7	54	7	90	7	135
1	110	2	221	3	300	/																																																			
1	184	2	368	3	510	/																																																			
1	276	2	553	3	750	/																																																			
2	221	3	300	/																																																					
2	368	3	510	/																																																					
2	553	3	750	/																																																					
3	300	/																																																							
3	510	/																																																							
3	750	/																																																							
7	54																																																								
7	90																																																								
7	135																																																								

I Le condizioni ottimali di funzionamento dell'apparecchio sono garantite soltanto per oscillazioni della tensione in uscita dall'alimentatore del $\pm 2\%$ rispetto al valore nominale. La conformità alla norma è garantita soltanto utilizzando trasformatori iGuzzini (art.: BZ98 - BZ99 - BZA0 - MXF9) od equivalenti di tipo SELV che rispondano alle vigenti norme C.E.I.

GB Optimum operating condition for the fitting is ensured only if the oscillations of the ballast output voltage are $\pm 2\%$ the nominal value. Compliance with the regulation is ensured only if either iGuzzini transformers (art.: BZ98 - BZ99 - BZA0 - MXF9) or equivalent transformers (SELV type) meeting the C.E.I. regulations in force are used.

F Les conditions optimales de fonctionnement de l'appareil ne sont assurées que pour des oscillations de la tension de sortie du ballast de $\pm 2\%$ par rapport à la valeur nominale. La conformité à la norme n'est assurée qu'en cas d'utilisation de transformateurs iGuzzini (réf.: BZ98 - BZ99 - BZA0 - MXF9) ou équivalents type SELV conformes aux normes C.E.I.

D Die optimalen Funktionsbedingungen der Leuchte sind nur bei Schwankungen der Vorschaltgeräte-Ausgangsspannung um $\pm 2\%$ im Vergleich zum Sollwert gewährleistet. Die Übereinstimmung mit den Vorschriften ist nur bei Verwendung von iGuzzini-Transformatoren (Art.: BZ98 - BZ99 - BZA0 - MXF9) oder gleichwertigen des Typs SELV, die den gültigen CEI-Bestimmungen entsprechen, gewährleistet.

NL De optimale condities voor de werking van het apparaat zijn alleen gegarandeerd voor uitgaande spanningsvariëaties van $\pm 2\%$ ten opzichte van de nominale waarde van het voorschakelapparaat. De conformiteit aan de norm wordt alleen gegarandeerd als u iGuzzini voorschakelapparaten gebruikt (art.: BZ98 - BZ99 - BZA0 - MXF9) of overeenkomstige, van het type SELV, die aan de geldende C.E.I. normen voldoen.

E Las condiciones de funcionamiento optimales del aparato se garantizan solamente con oscilaciones de la tensión de salida del alimentador de $\pm 2\%$ respecto al valor nominal. La conformidad a la norma se garantiza solamente con el uso de transformadores iGuzzini (art. BZ98 - BZ99 - BZA0 - MXF9) o equivalentes de tipo SELV que cumplen las normas vigentes C.E.I.

DK Armaturet kan kun fungere optimalt, hvis det maksimale udgangsspændingsudsving ligger mellem $\pm 2\%$ i forhold til den nominelle værdi. Opfyldelse af reglerne garanteres kun ved brug af transformatorer fra iGuzzini (art.: BZ98 - BZ99 - BZA0 - MXF9) eller lignende af typen SELV, der opfylder de gældende CEI-regler.

N Optimal driftsbetingelse for armaturen sikres kun hvis svingningene av ballastens utmatingspenninng er $\pm 2\%$ av nominell verdi. Overhold av regulasjonen sikres kun hvis enten iGuzzini-transformere (art. BZ98 - BZ99 - BZA0 - MXF9) eller tilsvarende transformere (SELV-type) som møter C.E.I.-s kravene som gjelder brukes.

S Utrustningens optimala driftförhållanden garanteras endast vid en matningsspänningsoscillation vid utgången på $\pm 2\%$ i förhållande till nominellt värde. Överensstämmelse med standard garanteras endast genom att använda transformatorer av typ iGuzzini (art.: BZ98 - BZ99 - BZA0 - MXF9) eller motsvarande av typ SELV som överensstämmer med gällande C.E.I.-standard.

RUS Оптимальные рабочие условия прибора гарантируются только в случае колебания напряжения на выходе из блока питания на $\pm 2\%$ по отношению к номинальному значению. Соответствие нормативу гарантируется только при использовании трансформаторов iGuzzini (арт. BZ98 - BZ99 - BZA0 - MXF9) или подобных типа SELV, отечающих требованиям действующих нормативов ЕЭС.

CN 仅在镇流器输出电压浮动度为正常值的 $\pm 2\%$ 时,能保证装置的最佳运行条件.仅在使用iGuzzini变压器(art. BZ98 - BZ99 - BZA0 - MXF9)或等效变压器(SELV类型)符合C.E.I.规定时,可保证符合标准.

I Per progetti d'impianto personalizzati l'azienda iGuzzini fornisce, previa documentazione necessaria, i dati relativi al numero dei prodotti installabili e la lunghezza dei cavi, in funzione dell'alimentatore e del tipo di cavo utilizzato.

GB For customised installation projects iGuzzini is able to supply - accompanied by the necessary documentation - the details of the number of installable products and the length of the cables based on the ballast and type of cable used.

FR Pour des projets d'installation personnalisés, veuillez transmettre la documentation nécessaire à l'entreprise iGuzzini, qui s'occupera d'indiquer le nombre de produits à installer ainsi que la longueur des câbles, en fonction du ballast et du type de câble utilisés.

DE Für personalisierte Anlagenprojekte liefert das Unternehmen iGuzzini nach Vorlage der erforderlichen Dokumentation die Angaben bezüglich der Anzahl der installierbaren Leuchten sowie die Kabellänge in Abhängigkeit vom Vorschaltgerät und von der Art des verwendeten Kabels.

NL Na ontvangst van het benodigde documentatiemateriaal kan het bedrijf iGuzzini bij gepersonaliseerde installatie-ontwerpen informatie verschaffen betreffende het aantal installeerbare producten en de lengte van de kabels voor het voorschakelapparaat, aan de hand van het type kabel wat gebruikt zal worden.

E Para proyectos personalizados y previo conocimiento de la documentación necesaria, iGuzzini puede suministrar datos sobre el número de productos a instalar y la longitud de los cables en función de alimentador y tipo de cable utilizado.

DK Ved skræddersyede anlæg fremsender iGuzzini dokumentation med alle oplysninger vedrørende antallet af produkter, der kan installeres, og kabellængde, alt efter typen af strømforsyning og kabel.

N For spesialtilpassede installasjonsprosjekter er iGuzzini i stand til å levere - sammen med den nødvendige dokumentasjonen - detaljene på installerbare produkter og lengden på kablene basert på ballast og type kabel som brukes.

S För kundpassade installationer tillhandahåller iGuzzini (efter nödvändig dokumentation) data angående antalet produkter som kan installeras och kabellängd, beroende på typen av strömförsörjningsanordning och kabel som används.

RUS Для индивидуальных проектов осветительных систем, после получения всей необходимой документации заказчика, Компания iGuzzini предоставляет сведения о количестве изделий, которые могут быть установлены, и о длине проводов в зависимости от блока питания и от типа используемого провода.

CN 对于iGuzzini公司个性化的装配系统设计,根据所使用的供电器材以及电线的种类,提供有关文件,安装的产品数据以及电线的长度.

SOSTITUZIONE DEL LED
REPLACING THE LED
REPLACEMENT DE LA LED
AUSTAUSCHEN DER LED
VERVANGEN VAN DE LED
REEMPLAZO DEL LED
UDSKIFTNING AF LYSDIODE
BYTE AV LYSDIOD
UTSKIFTNING AV DEN LYSEMITTERENDE DIODEN
ЗАМЕНА СИДА
发光二极管替换

I N.B.: Per la sostituzione del LED contattare l'azienda iGuzzini.
GB N.B.: For information on LED replacement please contact iGuzzini.
 F N.B.: Pour procéder au remplacement de la LED, adressez-vous à la société iGuzzini.
 D Ñ.B.: Bezüglich des Austausches der LED kontaktieren Sie bitte die Firma iGuzzini.
NL N.B.: Voor het vervangen van de LED neemt u contact op met het bedrijf iGuzzini.
 E **NOTA:** Para sustituir el LED llame a la empresa iGuzzini.
DK N.B.: For udskiftning af lysdioden, skal man kontakte iGuzzini.
 N N.B.: For informasjon om skifte av LED, vennligst ta kontakt med iGuzzini.
S **OBS!** För byte av lysdioden, kontakta företaget iGuzzini.
RUS **ПРИМЕЧАНИЕ:** Для замены СИДов обращайтесь в компанию iGuzzini.
CN **注意:** 如需LED更换的信息, 请联系iGuzzini.

Nella progettazione dell'impianto illuminotecnico ed elettrico, determinare le correnti massime ammissibili, considerando i seguenti fattori:
 - 16A: corrente nominale ammessa dalle morsettiere (BJ88 - BJ89 - BJ90 - BJ91 - BJ92 - BJ93 - BJ94 - BJ95 - BJ96 - BJ97 - BJ98 - BJ99 - BK00 - BK01 - BK02 - BK03 - BK04 - BK05 - BK06 - BK07 - BK14 - BK15 - BK16 - BK17 - BK08 - BK09 - BK10 - BK11 - BK12 - BK13);
 - coefficiente di sicurezza per tenere conto delle sovratensioni e contemporaneità;
 - corrente nominale assorbita dai singoli art.
 E' buona norma evitare di far lavorare i conduttori dei cavi ai massimi valori.

When planning the lighting and electrical system, determine the maximum permitted current, taking into account the following factors:
 - 16A: the nominal current permitted by terminal blocks (BJ88 - BJ89 - BJ90 - BJ91 - BJ92 - BJ93 - BJ94 - BJ95 - BJ96 - BJ97 - BJ98 - BJ99 - BK00 - BK01 - BK02 - BK03 - BK04 - BK05 - BK06 - BK07 - BK14 - BK15 - BK16 - BK17 - BK08 - BK09 - BK10 - BK11 - BK12 - BK13);
 - safety coefficient to allow for excess voltage and contemporaneity;
 - the nominal current absorbed by single art.
 It is recommended that the wires inside the cables are made to operate at the maximum values.

Lors de l'étude de projet de l'installation d'éclairage et de l'installation électrique, déterminer les courants maximaux admissibles en tenant compte des facteurs suivants :
 - 16A: courant maximal admis par les borniers (BJ88 - BJ89 - BJ90 - BJ91 - BJ92 - BJ93 - BJ94 - BJ95 - BJ96 - BJ97 - BJ98 - BJ99 - BK00 - BK01 - BK02 - BK03 - BK04 - BK05 - BK06 - BK07 - BK14 - BK15 - BK16 - BK17 - BK08 - BK09 - BK10 - BK11 - BK12 - BK13);
 - coefficient de sécurité tenant compte des surtensions et de la simultanéité;
 - courant nominal absorbé par les différents art.
 Il est conseillé de ne pas faire fonctionner les câbles aux valeurs maximales.

Bei der Planung einer Beleuchtungs- und Elektroanlage bestimmen Sie die zulässigen Höchstströme unter Berücksichtigung folgender Faktoren:
 - 16A: von den Klemmleisten zugelassener Nennstrom (BJ88 - BJ89 - BJ90 - BJ91 - BJ92 - BJ93 - BJ94 - BJ95 - BJ96 - BJ97 - BJ98 - BJ99 - BK00 - BK01 - BK02 - BK03 - BK04 - BK05 - BK06 - BK07 - BK14 - BK15 - BK16 - BK17 - BK08 - BK09 - BK10 - BK11 - BK12 - BK13);
 - Sicherheitskoeffizient zur Einbeziehung von Überspannung und Gleichzeitigkeit;
 - von den einzelnen art. aufgenommener Nennstrom.
 Es ist bewährte Praxis, die Leiter der Kabel möglichst nicht den Höchstwerten auszusetzen.

Bij het ontwerpen van de verlichtingstechnische en elektrische installatie moet u de maximaal toegestane stroomtoevoer vaststellen door rekening te houden met de volgende factoren:
 - 16A: nominale stroom toegestaan op klemmenstroken (BJ88 - BJ89 - BJ90 - BJ91 - BJ92 - BJ93 - BJ94 - BJ95 - BJ96 - BJ97 - BJ98 - BJ99 - BK00 - BK01 - BK02 - BK03 - BK04 - BK05 - BK06 - BK07 - BK14 - BK15 - BK16 - BK17 - BK08 - BK09 - BK10 - BK11 - BK12 - BK13);
 - veiligheidscoëfficiënt om rekening te houden met overspanning en gelijktijdigheid;
 - nominale opgenomen stroom van de enkele Art.
 We raden u aan de kabelgeleiders nooit op maximaal vermogen te laten functioneren.

Durante la proyectación de la instalación luminotécnica y eléctrica, determinar las corrientes máximas permitidas, en consideración de los factores siguientes:
 - 16A: corriente nominal permitida de las borneras (BJ88 - BJ89 - BJ90 - BJ91 - BJ92 - BJ93 - BJ94 - BJ95 - BJ96 - BJ97 - BJ98 - BJ99 - BK00 - BK01 - BK02 - BK03 - BK04 - BK05 - BK06 - BK07 - BK14 - BK15 - BK16 - BK17 - BK08 - BK09 - BK10 - BK11 - BK12 - BK13);
 - coeficiente de seguridad para considerar sobretensiones y contemporaneidades;
 - corriente nominal absorbida por los art. individuales.
 Se aconseja evitar que los conductores de cables trabajen con valores máximos.

I projekteringen af det belysningstekniske og elektriske anlæg, skal man undersøge den maks. tilladte strømstyrke, idet man tager højde for følgende:
 - 16A: nominal tilladte strømstyrke fra klemrækkerne (BJ88 - BJ89 - BJ90 - BJ91 - BJ92 - BJ93 - BJ94 - BJ95 - BJ96 - BJ97 - BJ98 - BJ99 - BK00 - BK01 - BK02 - BK03 - BK04 - BK05 - BK06 - BK07 - BK14 - BK15 - BK16 - BK17 - BK08 - BK09 - BK10 - BK11 - BK12 - BK13);
 - sikkerhedskoefficient for at sikre mod overspænding og samtidighed
 - nominal absorberet strømstyrke på de enkelte dele
 Man bør undgå at udsætte ledningerne for maks. belastning.

RUS При расчете светотехнической системы и электропроводки определите максимальный допустимый ток с учетом следующих факторов:
 - 16А: номинальный допустимый ток, доступный в клеммных колодках;
 (BJ88 - BJ89 - BJ90 - BJ91 - BJ92 - BJ93 - BJ94 - BJ95 - BJ96 - BJ97 - BJ98 - BJ99 - BK00 - BK01 - BK02 - BK03 - BK04 - BK05 - BK06 - BK07 - BK14 - BK15 - BK16 - BK17 - BK08 - BK09 - BK10 - BK11 - BK12 - BK13);
 - коэффициент безопасности для учета перенапряжения и одновременного включения;
 - номинальный ток, поглощаемый отдельными изделиями.
 Не следует подвергать провода кабелей рабочему режиму с максимальными значениями.

CN 设计电器、照明设备的时候必须参照下列数据, 确定允许的最大电流:
 - 16A: 接头允许的额定电流
 (BJ88 - BJ89 - BJ90 - BJ91 - BJ92 - BJ93 - BJ94 - BJ95 - BJ96 - BJ97 - BJ98 - BJ99 - BK00 - BK01 - BK02 - BK03 - BK04 - BK05 - BK06 - BK07 - BK14 - BK15 - BK16 - BK17 - BK08 - BK09 - BK10 - BK11 - BK12 - BK13);
 - 为监控电压与同时性的安全系数;
 - 每个组件的额定吸收电流。
 请避免让电缆的导体在最高数据下运行。

ORIENTAMENTO DEL VANO OTTICO - ADJUSTING THE POSITION OF THE OPTICAL ASSEMBLY
ORIENTATION DU GROUPE OPTIQUE - AUSRICHTEN DES LAMPENANSCHLUSSES
HET RICHTEN VAN HET VERLICHTINGSARMATUUR - ORIENTABILIDAD DE LA OPTICA
INDSTILLING AF DEN OPTISKE ENHED - ОРИЕНТАЦИЯ ЛАМПОВОГО ОТСЕКА
OPTISKE RUM 可调光的位置

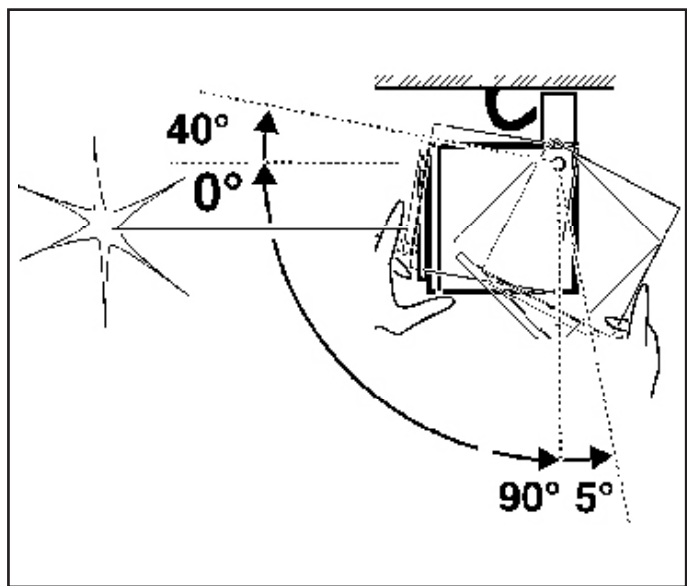
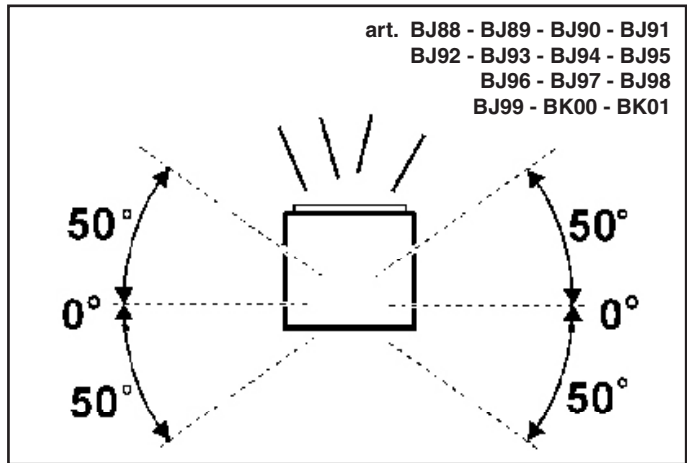

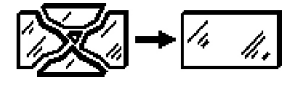

I In caso di rottura del vetro il prodotto non può essere utilizzato, contattare il costruttore per la sua sostituzione.
GB Should the glass break, the product cannot be used. Contact the manufacturer about its replacement.
 F En cas de cassure du verre, ne pas utiliser le produit et contacter aussitôt le fabricant pour son remplacement.
 D Im Falle einer Beschädigung des Glases darf das Produkt nicht verwendet werden. Setzen Sie sich bitte mit dem Hersteller in Verbindung, der für den Ersatz sorgen wird.
NL In geval het glas gebroken is kan het product niet worden gebruikt. Neem contact op met de fabrikant voor de vervanging van het glas.
 E En caso de ruptura del cristal no utilizar el producto y contactar el fabricante para la sustitución.
DK Hvis produktets glas ødelægges, kan det ikke anvendes. Kontakt forhandleren med henblik på udskiftning.
 N I tilfelle glasset går i stykker kan produktet ikke tas i bruk, kontakt produsenten for utskifting av det.
 S Om glaset går sönder kan inte produkten användas. Kontakta tillverkaren för att byta ut glaset.
RUS В случае разбивания стекла не используйте прибор, обратитесь к его производителю для замены.
CN 一旦玻璃破碎后产品将不能再使用, 须联系生产商予以更换。

N.B.: DURANTE L'INSTALLAZIONE DEL SISTEMA "IPRO" RISPETTARE SCRUPOLOSAMENTE LE NORME IMPIANTISTICHE NAZIONALI VIGENTI.

N.B.: WHEN INSTALLING THE "IPRO" SYSTEM, MAKE SURE ALL CURRENT NATIONAL REGULATIONS RELATING TO INSTALLATION ARE OBSERVED.

N.B.: LORS DE L'INSTALLATION DU SYSTÈME "IPRO" VEUILLEZ RESPECTER RIGOREUSEMENT LES NORMES EN VIGUEUR EN LA MATIÈRE DANS LE PAYS.

N.B.: BEACHTEN SIE BEI DER INSTALLATION DES SYSTEMS "IPRO" UNBEDINGT DIE IM LAND GELTENDEN ANLAGETECHNISCHEN VORSCHRIFTEN.

N.B.: BIJ HET INSTALLEREN VAN HET "IPRO" SYSTEEM MOET U DE GELDENDE NATIONALE INSTALLATIENORMEN STRIKT NALEVEN.

NOTA: DURANTE LA INSTALACIÓN DEL SISTEMA "IPRO" RESPETAR ESCRUPULOSAMENTE LAS NORMAS NACIONALES DE INSTALACIÓN EN VIGOR.

N.B.: UNDER INSTALLATION AF "IPRO" SYSTEMET SKAL MAN NØJE OVERHOLDE DE GÆLDENDE REGLER FOR DISSE ANLÆG.

N.B.: UNDER INSTALLASJON AV SYSTEMET "IPRO" MÅ DE NASJONALE ANLEGGSFORSKRIFTENE OVERHOLDES NØYE.

OBS! UNDER INSTALLATIONEN AV SYSTEMET "IPRO" SKA GÄLLANDE NATIONELLA INSTALLATIONSFÖRESKRIFTER RESPEKTERAS I DETALJ.

ПРИМЕЧАНИЕ: В ПРОЦЕССЕ МОНТАЖА СИСТЕМЫ " IPRO " СТРОГО СОБЛЮДАЙТЕ НАЦИОНАЛЬНЫЕ ДЕЙСТВУЮЩИЕ НОРМАТИВЫ ПО ЭЛЕКТРОПРОВОДКЕ.

注意: 在安装 " IPRO " 系统时请遵守设备的安装规定.

I L'altezza massima di installazione è di m 15.

GB The maximum installation height is 15 m.

F La hauteur maximum d'installation est de 15 m.

D Die maximale Installationshöhe beträgt 15 m.

NL De maximum hoogte van installeren is 15 m.

E La altura máx. de instalación es de 15 m.

DK Minimumshøjden ved installation er 15 m.

N Maksimal installasjonshøyde er 15 meter.

S Max. installationshöjd är 15 m.

RUS Максимальная высота установки 15 м.

CN 安装的最高高度是15米。

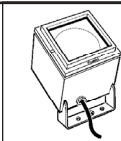

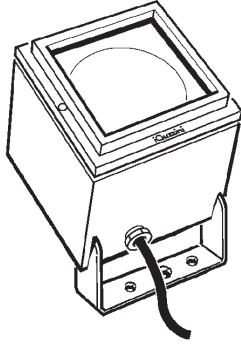

**iPRO LED
(MICRO)**

تحذير :

لا يمكن ضمان سلامة هذا الجهاز إلا إذا التزمت بهذه التعليمات. يجب حفظها في مكان آمن.

ATTENZIONE:

LA SICUREZZA DELL'APPARECCHIO E' GARANTITA SOLO CON L'USO APPROPRIATO DELLE SEGUENTI ISTRUZIONI; PERTANTO E' NECESSARIO CONSERVARLE.

WARNING:

THE SAFETY OF THIS FIXTURE IS GUARANTEED ONLY IF YOU COMPLY WITH THESE INSTRUCTIONS; REMEMBER TO CONSERVE IN A SAFE PLACE.

ATENCION:

LA SEGURIDAD DEL APARATO SE GARANTIZA SOLO CUMPLIENDO CUIDADOSAMENTE LAS SIGUIENTES INSTRUCCIONES; POR ELLO, ES NECESARIO CONSERVARLAS.

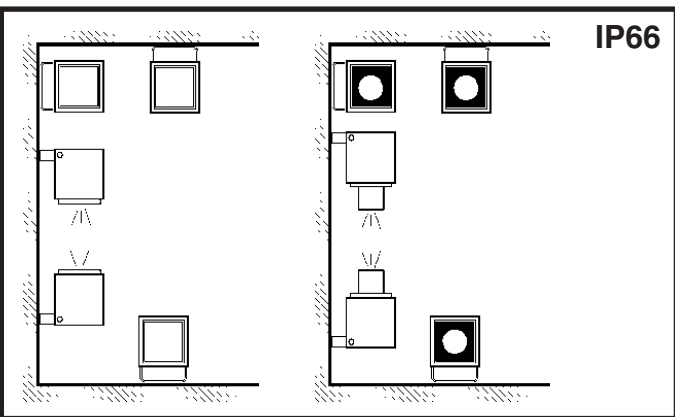
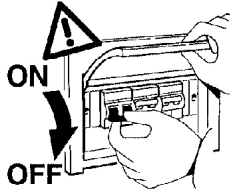

IP66

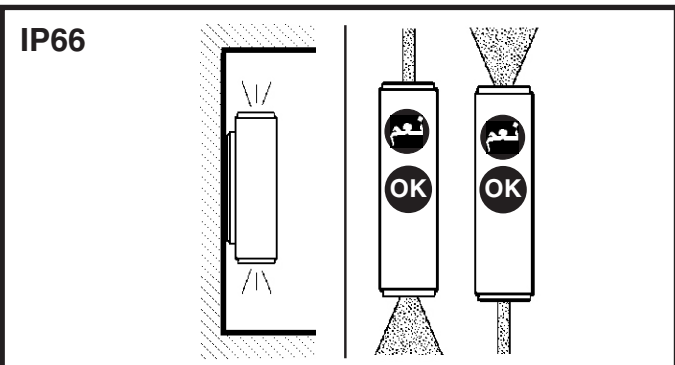

IP66

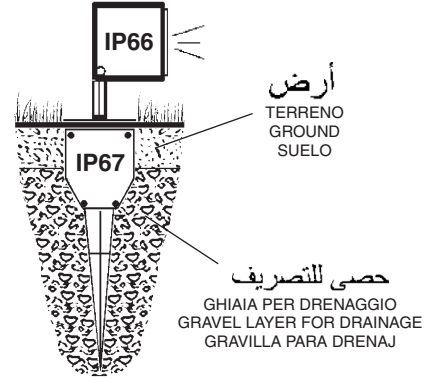

أقصى حجم ووزن ووسطح للتركيب بالملحقات

DIMENSIONI, PESO E SUPERFICIE DI MASSIMO INGOMBRO, DELLA COMPOSIZIONE COMPLETA DI ACCESSORI.

MAXIMUM SIZE, WEIGHT AND AREA OF THE COMPOSITION COMPLETE WITH AND ACCESSORIES.

DIMENSIONES, PESO Y SUPERFICIE MAXIMA DE OCUPACION, DEL CNJUNTO EQUIPADO CON ACCESORIOS.

الاصنف ART.	الوزن PESO WEIGHT PESO (Kg) كغم	الأبعاد Dimensioni Dimensions Dimensiones b x h (m) م	السطح Superficie Surface Superficie (mq) م ²
BJ88 - BJ89 BJ90 - BJ91 BJ92 - BJ93 BJ94 - BJ95 BJ96 - BJ97 BJ98 - BJ99 BK00 - BK01 BK02 - BK03 BK04 - BK05 BK06 - BK07 BK08 - BK09 BK10 - BK11 BK12 - BK13 BK14 - BK15 BK16 - BK17	0,260	0,05 x 0,05	0,003



art. الاصنف BJ88 - BJ89 - BJ90 - BJ91
BJ92 - BJ93 - BJ94 - BJ95
BJ96 - BJ97 - BJ98
BJ99 - BK00 - BK01

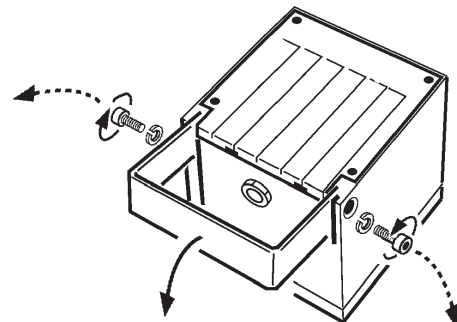

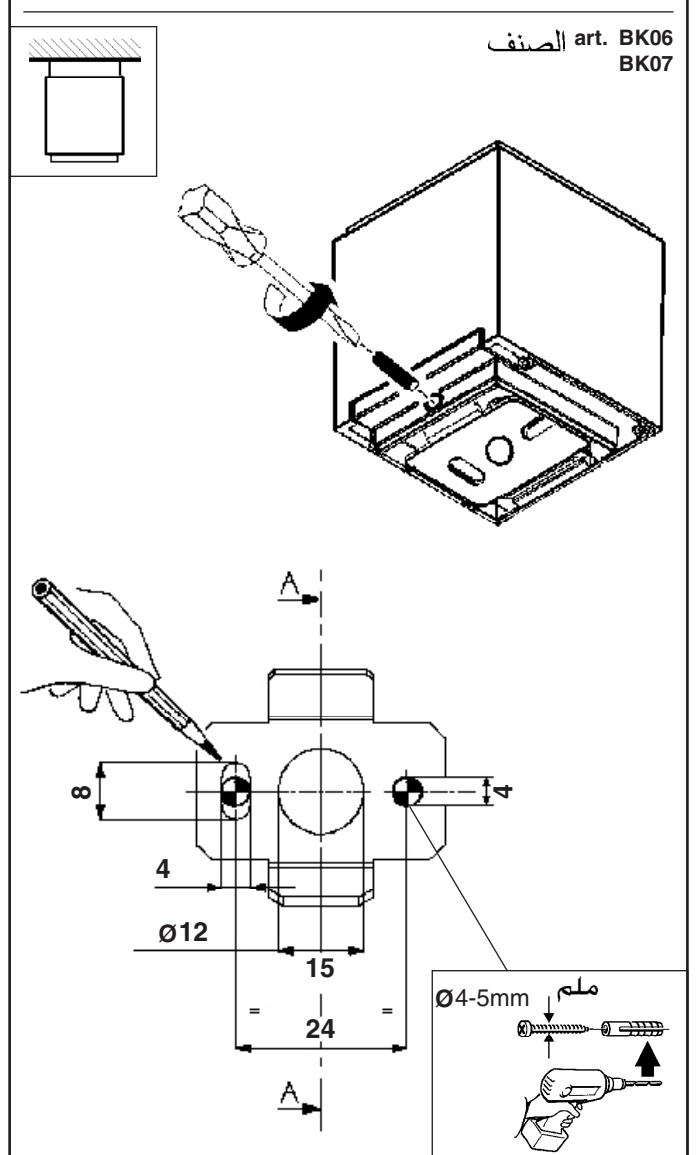
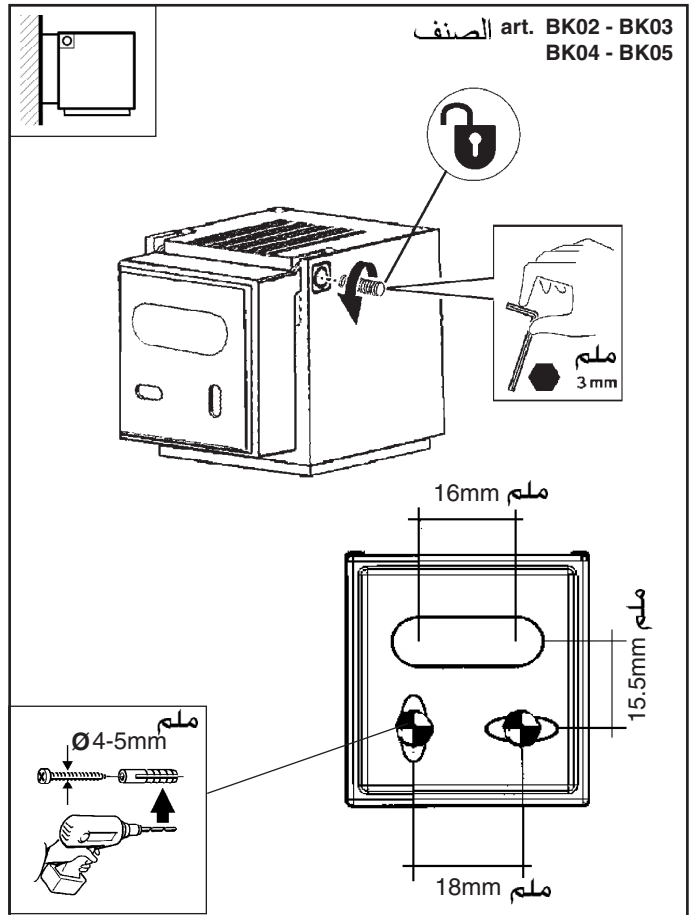
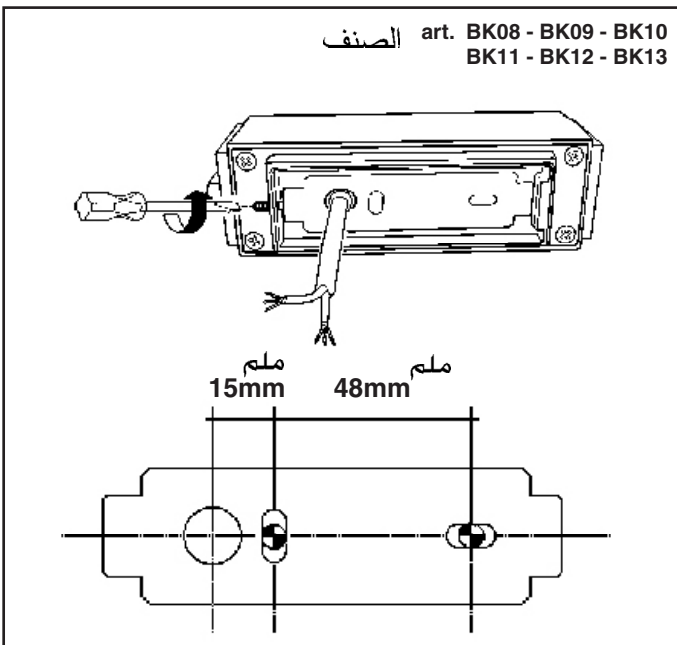
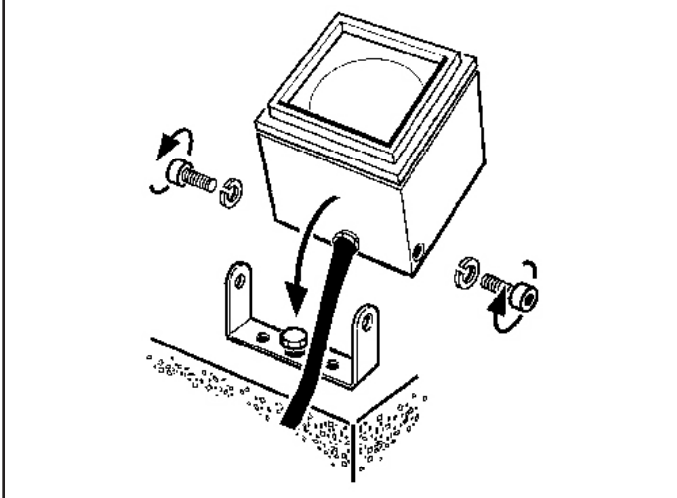
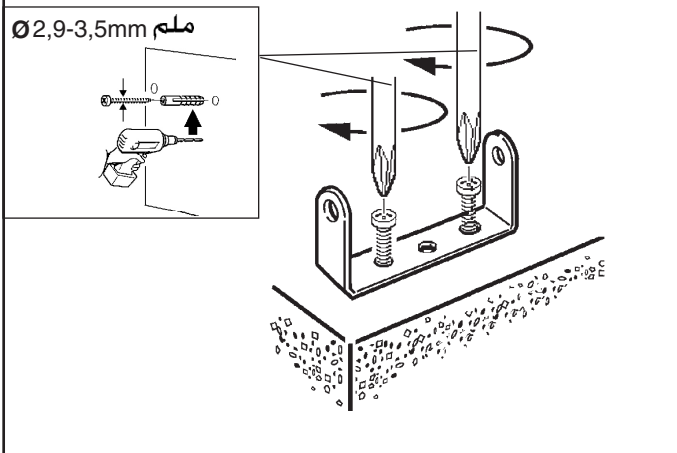
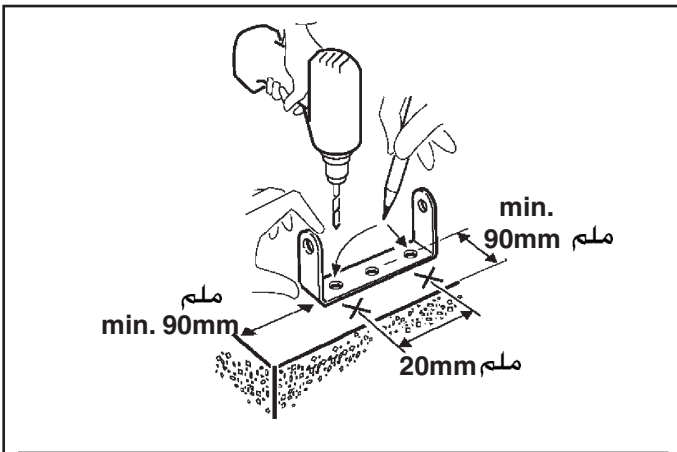

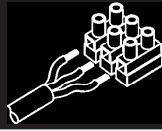

500 mA

art. BJ88 - BJ89 - BJ94
BJ95 - BJ96 - BJ97
BJ98 - BJ99

500 mA
700 mA

art. BJ90 - BJ91 - BJ92
BJ93 - BK00 - BK01

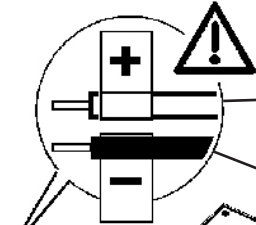

بني
MARRONE
BROWN
MARRÓN

أزرق
BLU
BLUE
AZUL

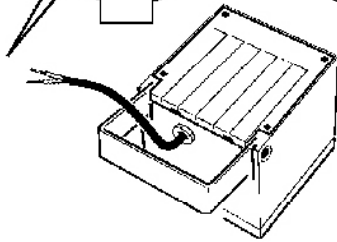

الصف art. BK08 - BK09 - BK10
BK11 - BK12 - BK13

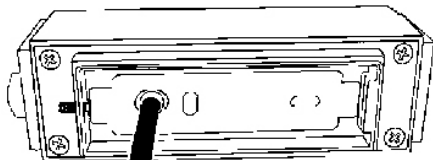

220/240V

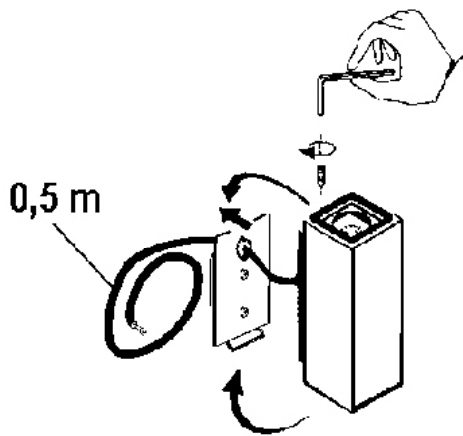
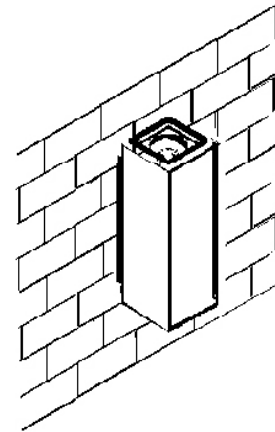
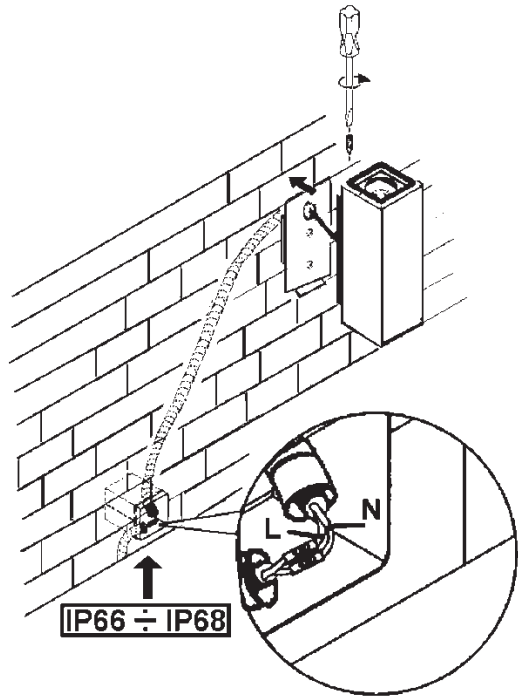
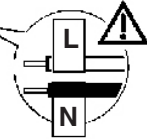

0,5 m

500 mA

art. BK02 - BK03
BK06 - BK07

500 mA
700 mA

art. BK04 - BK05

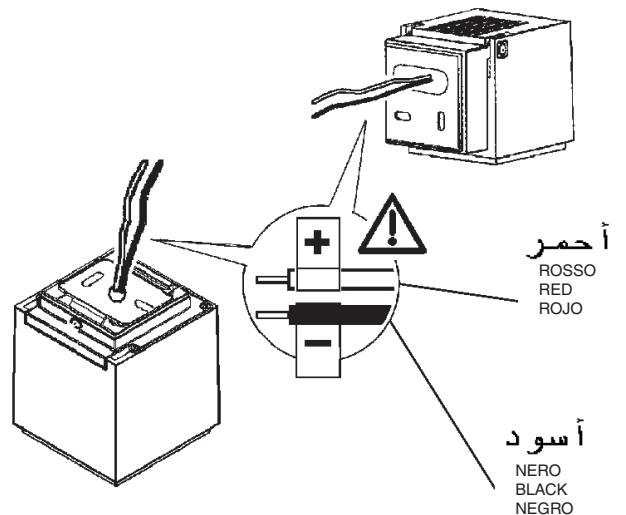

أحمر
ROSSO
RED
ROJO

أسود
NERO
BLACK
NEGRO

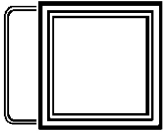

الصف art.9582

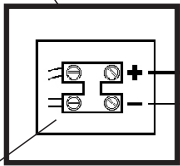
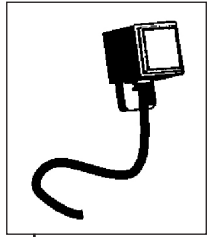

كبح
ALIMENTATORE
BALLAST
ALIMENTADOR

art.
BZ98 (6W)
BZ99 (12W)
BZA0 (20W)
MXF9 (17W)

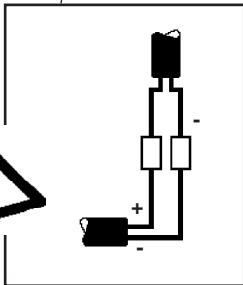

بني

MARRONE
BROWN
MARRÓN
(+)

أزرق
BLU
BLUE
AZUL
(-)

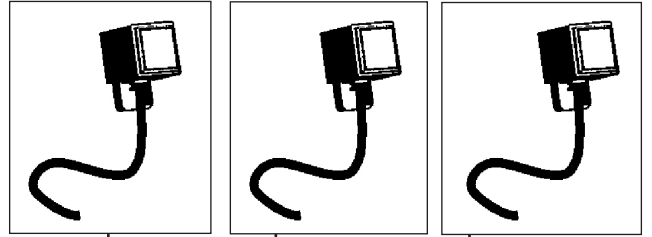
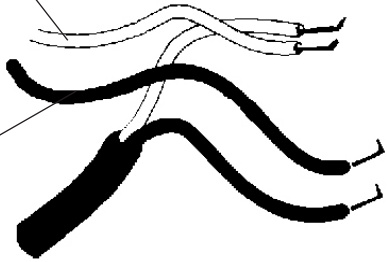

art.9582

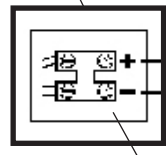

كبح
ALIMENTATORE
BALLAST
ALIMENTADOR

art.
BZ98 (6W)
BZ99 (12W)
BZA0 (20W)
MXF9 (17W)

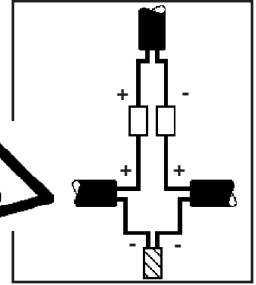

بني

MARRONE
BROWN
MARRÓN
(+)

أزرق
BLU
BLUE
AZUL
(-)

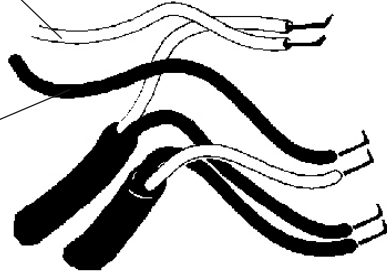

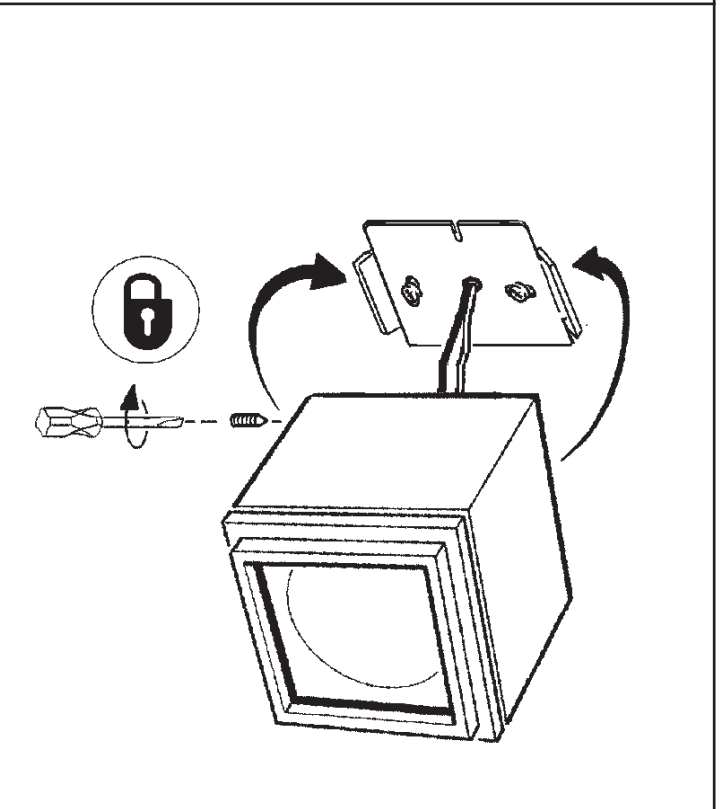
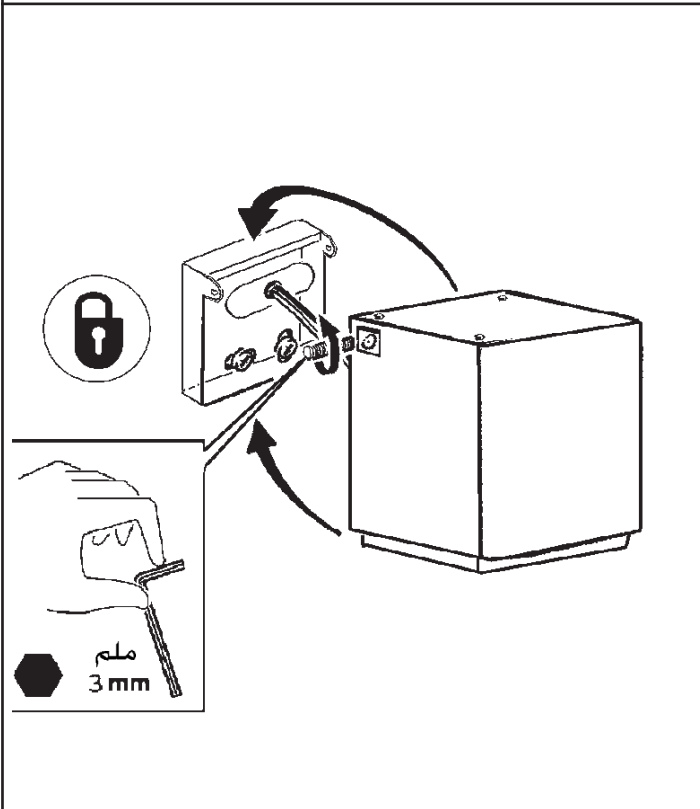
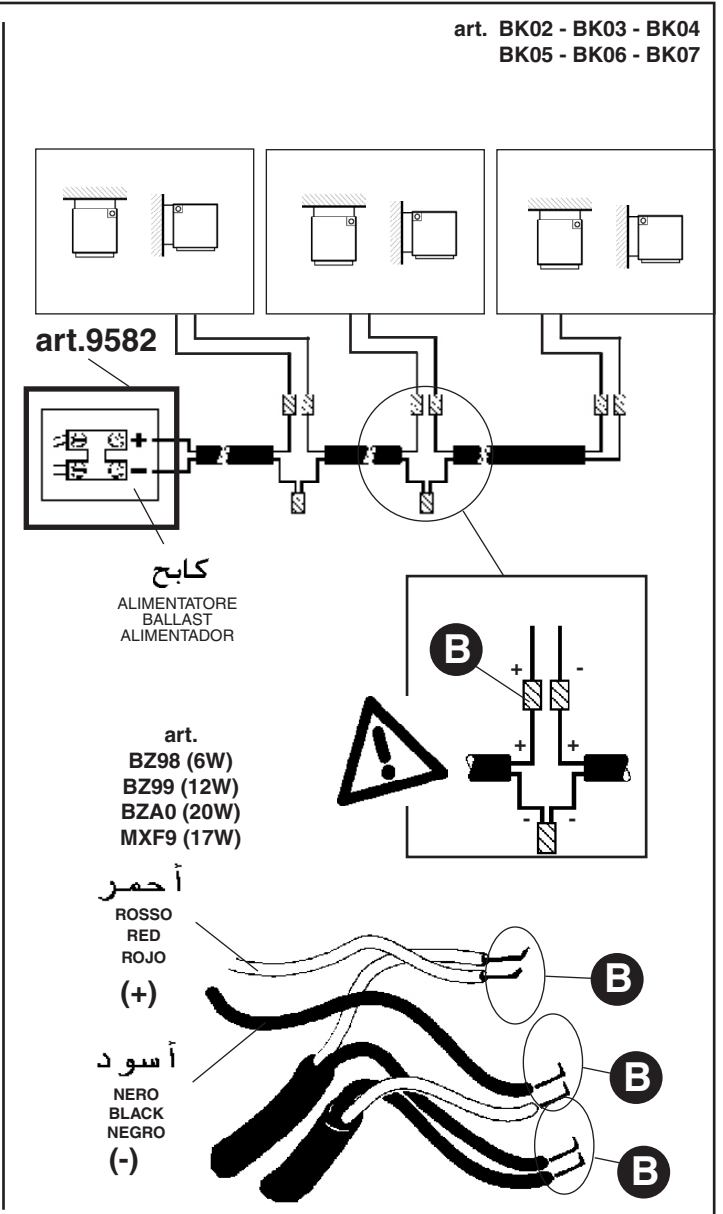
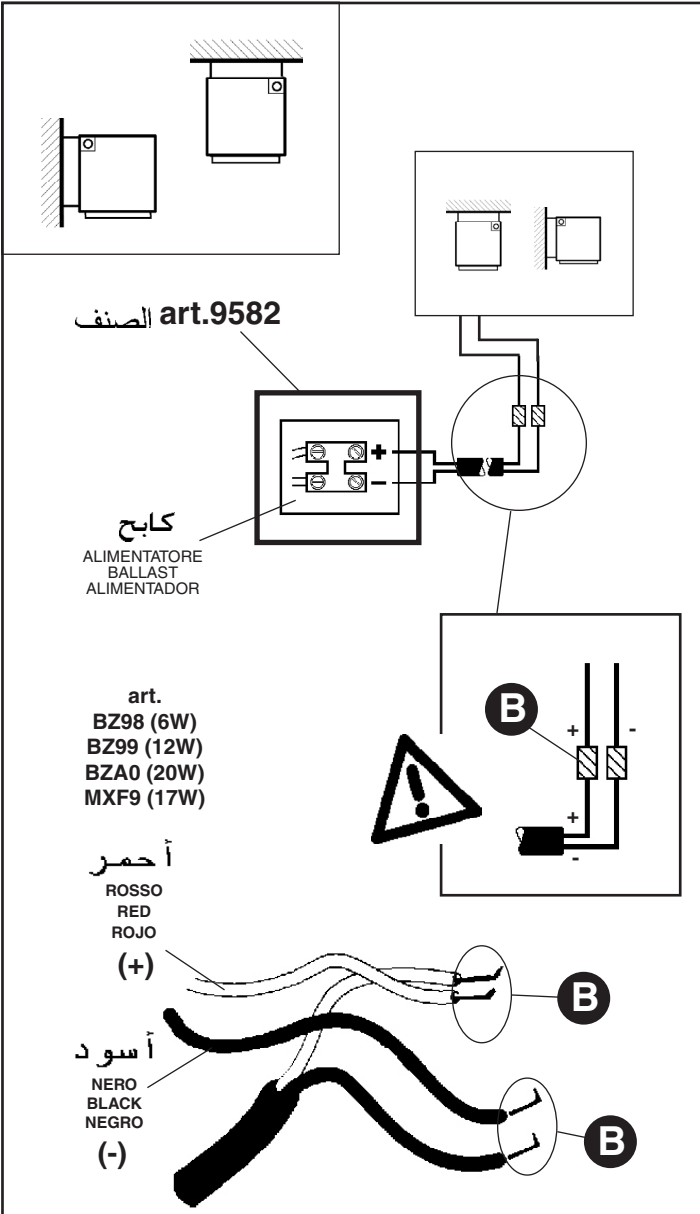

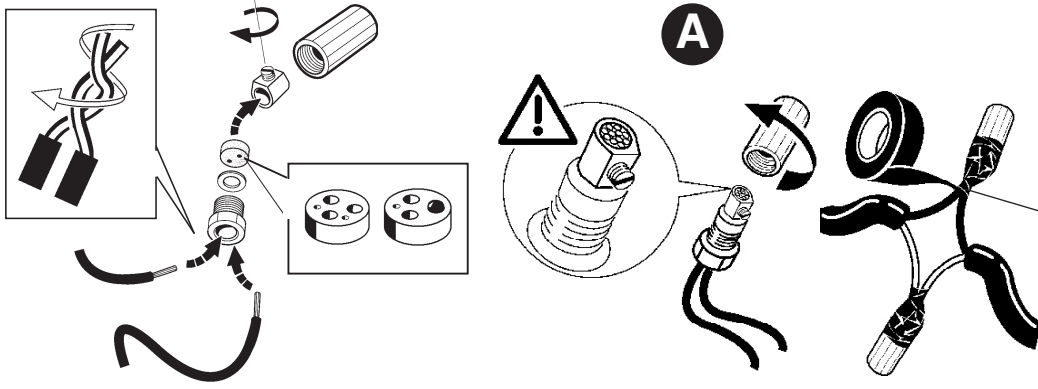

شريط يتكتل بشكل ذاتي
 NASTRO AUTOAGGLOMERANTE
 SELF-VULCANISING TAPE
 CINTA AUTOAGLOMERANTE
 (SCOTCH 23 3M)

ألحم
 STAGNARE
 WELD
 ESTANAR

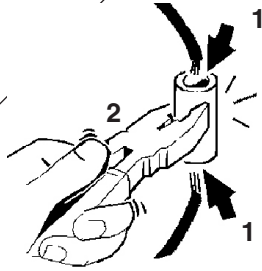

B

شريط يتكتل بشكل ذاتي
 NASTRO AUTOAGGLOMERANTE
 SELF-VULCANISING TAPE
 CINTA AUTOAGLOMERANTE
 (SCOTCH 23 3M)

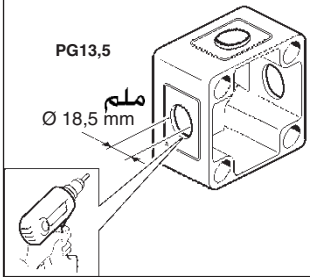
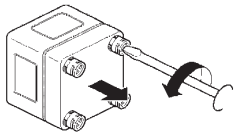

مصدر التيار
 ALIMENTAZIONE
 POWER SUPPLY
 CEBADOR

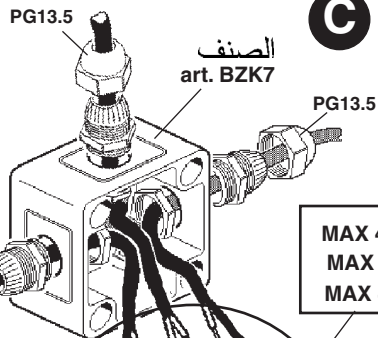

C

الصف art. BZK7

ملم 4 mm MAX
 32 A MAX
 400V MAX

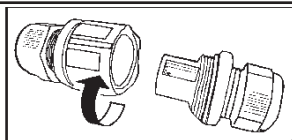
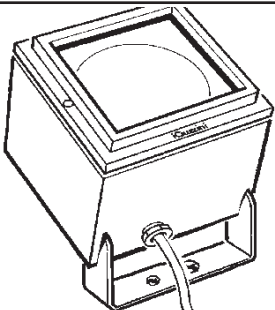
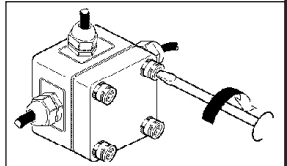
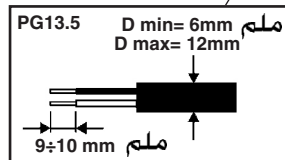
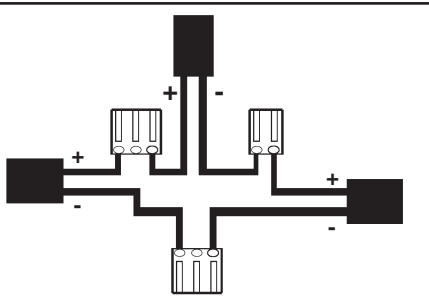

D

الصف art. BZK6

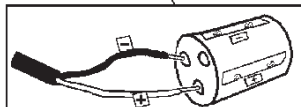
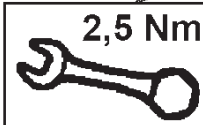

ملم 2,5 mm²

D (mm)	
6,5 ÷ 8 mm	
8 ÷ 9 mm	
9 ÷ 13 mm	

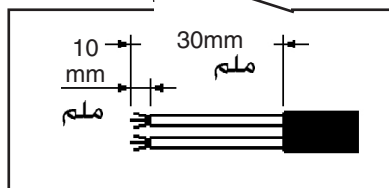
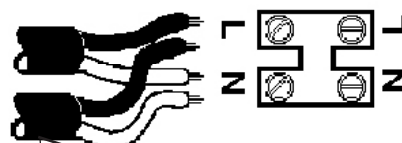
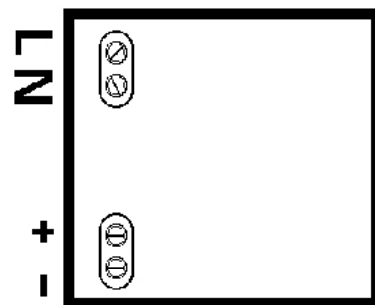
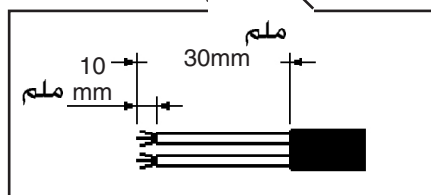
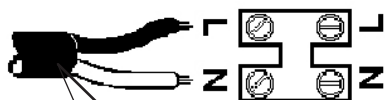
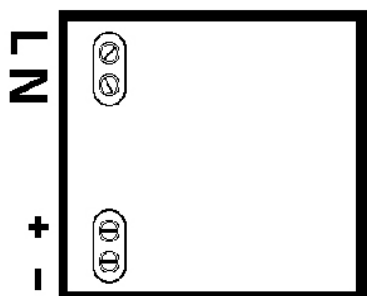
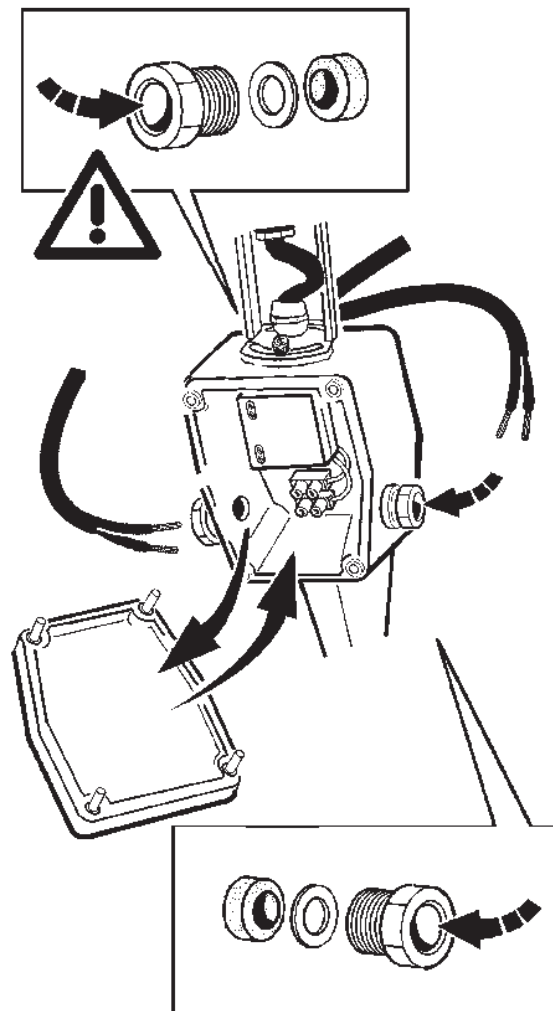
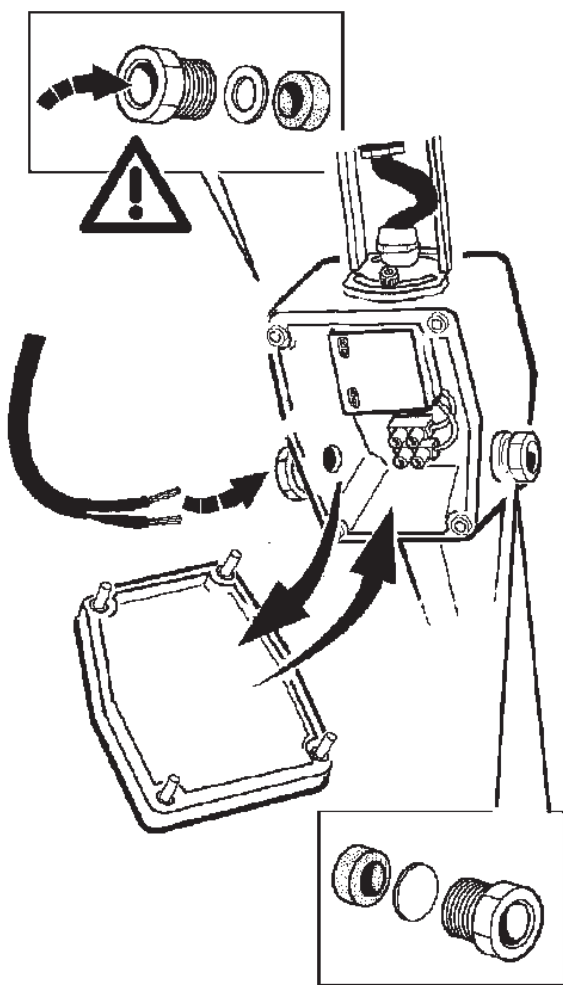

الصنف ART.	عامل القدرة fattore di potenza power factor factor de potencia	التيار الممتص corrente assorbita absorbed current corriente absorbida (A)
BK08 - BK09 BK10 - BK11 BK12 - BK13 BK14 - BK15 BK16 - BK17	0,35	0,08

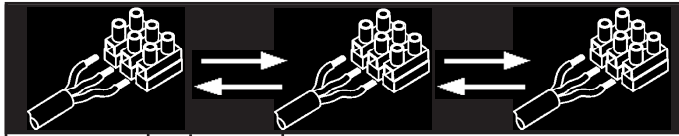

الصنف ART.	المقطع (W) Sezione Section Sección	كايح ALIMENTATORE BALLAST ALIMENTADOR							
	mm ²	art. BZ98 (6W) 500 mA		art. BZ99 (12W) 500 mA		art. BZA0 (20W) 500 mA		art. MXF9 (17W) 700 mA	
		max N°	L (m)	max N°	L (m)	max N°	L (m)	max N°	L (m)
BJ90 - BJ91 BJ92 - BJ93 BK00 - BK01 BK04 - BK05	1,6 ÷ 2,2	1,5 mm ²	/	/	/	/	/	7	54
		2,5 mm ²	/	/	/	/	/	7	90
		4 mm ²	/	/	/	/	/	7	135
BJ88 - BJ89 BJ94 - BJ95 BJ96 - BJ97 BJ98 - BJ99 BK06 - BK07 BK02 - BK03	4,8	1,5 mm ²	1	110	2	221	3	300	/
		2,5 mm ²	1	184	2	368	3	510	/
		4 mm ²	1	276	2	553	3	750	/

يتم ضمان عمل الجهاز بشكل جيد من خلال تأرجح فاطية التغذية الخارجة بنسبة $\pm 2\%$ مقارنة مع القيمة الاسمية.

يتم ضمان احترام المعايير السائدة فقط من خلال استعمال مهايئات من صنع شركة iGuzzini (سلع رقم (BZ98 - BZ99 - BZA0 - MXF9) أو ما يشابهها من نوع SELV المطابقة لمعايير مجموعة الدول الأوروبية C.E.I.

I Le condizioni ottimali di funzionamento dell'apparecchio sono garantite soltanto per oscillazioni della tensione in uscita dall'alimentatore del $\pm 2\%$ rispetto al valore nominale.
La conformità alla norma è garantita soltanto utilizzando trasformatori iGuzzini (art.: BZ98 - BZ99 - BZA0 - MXF9) od equivalenti di tipo SELV che rispondano alle vigenti norme C.E.I.

GB Optimum operating condition for the fitting is ensured only if the oscillations of the ballast output voltage are $\pm 2\%$ the nominal value.
Compliance with the regulation is ensured only if either iGuzzini transformers (art. BZ98 BZ99 - BZA0 - MXF9 or equivalent transformers (SELV type) meeting the C.E.I. regulations in force are used.

E Las condiciones de funcionamiento óptimas del aparato se garantizan solamente con oscilaciones de la tensión de salida del alimentador de $\pm 2\%$ respecto al valor nominal.
La conformidad a la norma se garantiza solamente con el uso de transformadores iGuzzini (art. BZ98 - BZ99 - BZA0 - MXF9) o equivalentes de tipo SELV que cumplen las normas vigentes C.E.I.

يضمن موفر الإضاءة الحديثة مزود لشركة iGuzzini بعد حصوله على الوثائق اللازمة. المعلومات تحفظ بعد المنتجات لغاية التركيب وضول الشبكات الكهربائية، هذه وحدة التغذية الكهربائية من نوع الكابل المتكامل.

I Per progetti d'impianto personalizzati l'azienda iGuzzini fornisce, previa documentazione necessaria , i dati relativi al numero dei prodotti installabili e la lunghezza dei cavi, in funzione dell'alimentatore e del tipo di cavo utilizzato.

GB For customised installation projects iGuzzini is able to supply - accompanied by the necessary documentation - details relating to the number of installable products and the length of the cables based on the ballast and type of cable used.

E Para proyectos personalizados y previo conocimiento de la documentación necesaria, iGuzzini puede suministrar datos sobre el número de productos a instalar y la longitud de los cables en función del alimentador y del tipo de cable utilizado.

استبدال الضوء

SOSTITUZIONE DEL LED
REPLACING THE LED
REEMPLAZO DEL LED

تنبيه: لاستبدال الضوء LED اتصل بشركة iGuzzini .

- I N.B.: Per la sostituzione del LED contattare l'azienda iGuzzini.
GB N.B.: For information on LED replacement please contact iGuzzini.
E NOTA: Para sustituir el LED llame a la empresa iGuzzini.

عند تصميم جهاز الإضاءة بالتمديدات الكهربائية يجب أخذ في الاعتبار العوامل التالية:

- 16 أمبير تيار اسمي مسموح به من قبل لومات أطراف التوصيل
BJ90 - BJ98 - BJ96 - BJ97 - BJ95 - BJ94 - BJ93 - BJ92 - BJ91
BJ99 - BJ98 - BJ97 - BJ96 - BJ95 - BJ94 - BJ93 - BJ92 - BJ91
BK08 - BK07 - BK06 - BK05 - BK04 - BK03 - BK02 - BK01 - BK00
BK13 - BK12 - BK11 - BK10 - BK09

- عامل الأمان للأمد بعين الاعتبار فيير الفاطية والترايس
- الفاطية الاسمية المخصصة من قبل المصنوع لتقوية.

منصح بعدم تشغيل موصلات الكابلات ضمن الحد الأقصى.

I Nella progettazione dell'impianto illuminotecnico ed elettrico, determinare le correnti massime ammissibili, considerando i seguenti fattori:

- 16A: corrente nominale ammessa dalle morsettiere (BJ88 - BJ89 - BJ90 - BJ91 - BJ92 - BJ93 - BJ94 - BJ95 - BJ96 - BJ97 - BJ98 - BJ99 - BK00 - BK01 - BK02 - BK03 - BK04 - BK05 - BK06 - BK07 - BK14 - BK15 - BK16 - BK17 - BK08 - BK09 - BK10 - BK11 - BK12 - BK13);
- coefficiente di sicurezza per tenere conto delle sovratensioni e contemporaneità;
- corrente nominale assorbita dai singoli art.

E' buona norma evitare di far lavorare i conduttori dei cavi ai massimi valori.

GB When planning the lighting and electrical system, determine the maximum permitted current, taking into account the following factors:

- 16A: the nominal current permitted by terminal blocks (BJ88 - BJ89 - BJ90 - BJ91 - BJ92 - BJ93 - BJ94 - BJ95 - BJ96 - BJ97 - BJ98 - BJ99 - BK00 - BK01 - BK02 - BK03 - BK04 - BK05 - BK06 - BK07 - BK14 - BK15 - BK16 - BK17 - BK08 - BK09 - BK10 - BK11 - BK12 - BK13);
- safety coefficient to allow for excess voltage and contemporaneity;
- the nominal current absorbed by single art.

It is recommended that the wires inside the cables are made to operate at the maximum values.

Durante la proyectación de la instalación luminotécnica y eléctrica, determinar las corrientes máximas permitidas, en consideración de los factores siguientes:

E - 16A: corriente nominal permitida de las borneras (BJ88 - BJ89 - BJ90 - BJ91 - BJ92 - BJ93 - BJ94 - BJ95 - BJ96 - BJ97 - BJ98 - BJ99 - BK00 - BK01 - BK02 - BK03 - BK04 - BK05 - BK06 - BK07 - BK14 - BK15 - BK16 - BK17 - BK08 - BK09 - BK10 - BK11 - BK12 - BK13);
- coeficiente de seguridad para considerar sobretensiones y contemporaneidades;
- corriente nominal absorbida por los art. individuales.
Se aconseja evitar que los conductores de cables trabajen con valores máximos.

ضبط موضع مجموعة العدسة

ORIENTAMENTO DEL VANO OTTICO
ADJUSTING THE POSITION OF THE OPTICAL ASSEMBLY
ORIENTABILIDAD DE LA OPTICA

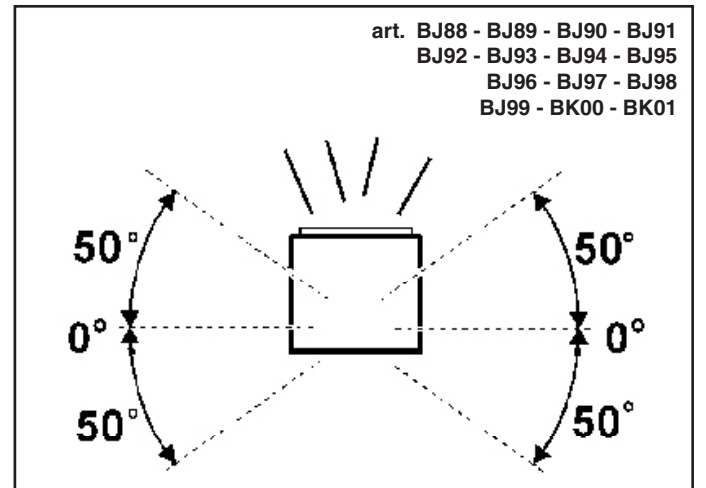

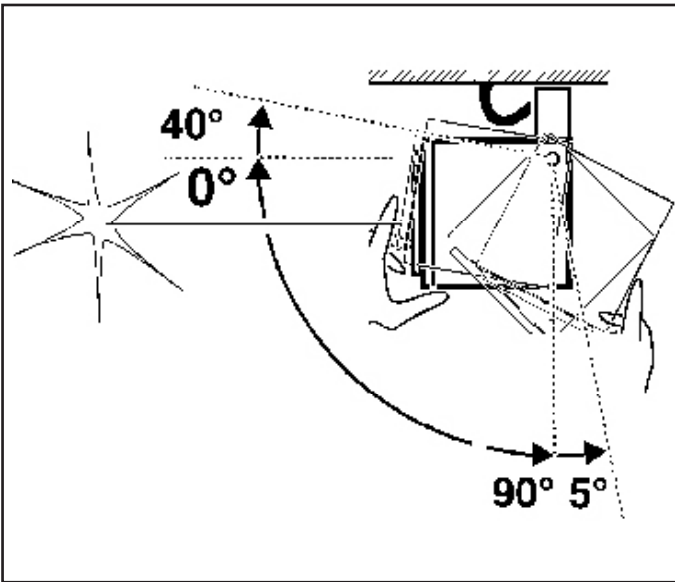

لا يمكن استعمال المنتج في حالة كسر الزجاج، وبالتالي يجب الاتصال بتصنيع لإستبداله. عن

I In caso di rottura del vetro il prodotto non può essere utilizzato, contattare il costruttore per la sua sostituzione.

GB Should the glass break, the product cannot be used and you should contact the manufacturer for its replacement.

E No utilizar el producto en caso de ruptura del vidrio y contactar el fabricante para la sustitución.

ملاحظة: ملاحظة: أثناء تركيب نظام "ipro" ، يجب التقيد بحرص بالنظم السائدة المتعلقة بالشبكة الكهربائية.

N.B.: DURANTE L'INSTALLAZIONE DEL SISTEMA "ipro" RISPETTARE SCRUPOLOSAMENTE LE NORME IMPIANTISTICHE NAZIONALI VIGENTI.

N.B.: WHEN INSTALLING THE "ipro" SYSTEM, MAKE SURE ALL CURRENT NATIONAL REGULATIONS RELATING TO INSTALLATION ARE OBSERVED.

NOTA: DURANTE LA INSTALACIÓN DEL SISTEMA "ipro" RESPETAR ESCRUPULOSAMENTE LAS NORMAS NACIONALES DE INSTALACIÓN EN VIGOR.

أقصى حد لارتفاع التركيب 15 متر.

I L'altezza massima di installazione è di m 15.

GB The maximum installation height is 15 m.

E La altura máx. de instalación es de 15 m.

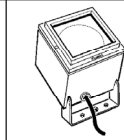

I PERIODO GIORNALIERO DI ACCENSIONE AMMESSO

iGuzzini

1.154.627.01
IS09175/01

GB ALLOWED DAILY OPERATION PERIOD

F DURÉE QUOTIDIENNE D'ALLUMAGE ADMISSIBLE

D ERLAUBTE TÄGLICHE EINSCHALTDAUER

NL DAGELIJKSE ONTSTEKINGSPERIODE TOEGESTAAN

E PERIODO DIARIO DE ENCENDIDO PERMITIDO

DK TILLADT TIDSRUM FOR DAGLIG TÆNDING

N TILLÄTT TENNINGSTID PR. DAG

S TILLÄTEN DAGLIG PERIOD SOM PRODUKTEN KAN VARA TÄND

RUS ЕЖЕДНЕВНАЯ ДОПУСТИМАЯ ПРОДОЛЖИТЕЛЬНОСТЬ РАБОТЫ

CN 允许的日常运营周期

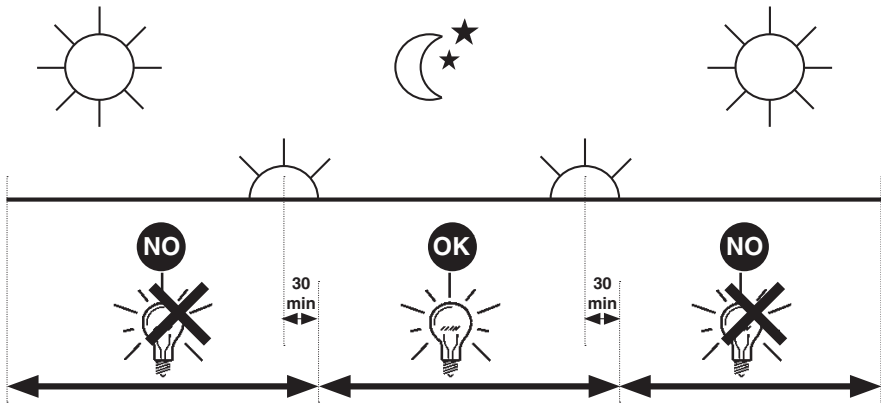

I PERIODO GIORNALIERO DI ACCENSIONE AMMESSO

iGuzzini

1.154.627.01
IS09175/01

GB ALLOWED DAILY OPERATION PERIOD

F DURÉE QUOTIDIENNE D'ALLUMAGE ADMISSIBLE

D ERLAUBTE TÄGLICHE EINSCHALTDAUER

NL DAGELIJKSE ONTSTEKINGSPERIODE TOEGESTAAN

E PERIODO DIARIO DE ENCENDIDO PERMITIDO

DK TILLADT TIDSRUM FOR DAGLIG TÆNDING

N TILLÄTT TENNINGSTID PR. DAG

S TILLÄTEN DAGLIG PERIOD SOM PRODUKTEN KAN VARA TÄND

RUS ЕЖЕДНЕВНАЯ ДОПУСТИМАЯ ПРОДОЛЖИТЕЛЬНОСТЬ РАБОТЫ

CN 允许的日常运营周期

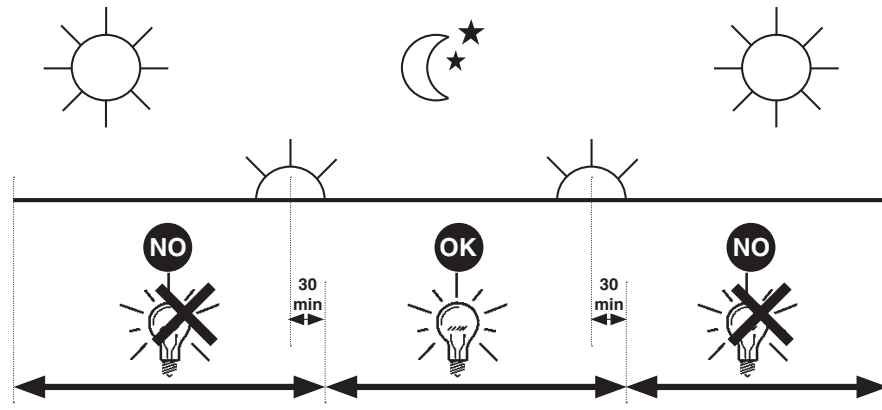

I PERIODO GIORNALIERO DI ACCENSIONE AMMESSO

iGuzzini

1.154.627.01
IS09175/01

GB ALLOWED DAILY OPERATION PERIOD

F DURÉE QUOTIDIENNE D'ALLUMAGE ADMISSIBLE

D ERLAUBTE TÄGLICHE EINSCHALTDAUER

NL DAGELIJKSE ONTSTEKINGSPERIODE TOEGESTAAN

E PERIODO DIARIO DE ENCENDIDO PERMITIDO

DK TILLADT TIDSRUM FOR DAGLIG TÆNDING

N TILLÄTT TENNINGSTID PR. DAG

S TILLÄTEN DAGLIG PERIOD SOM PRODUKTEN KAN VARA TÄND

RUS ЕЖЕДНЕВНАЯ ДОПУСТИМАЯ ПРОДОЛЖИТЕЛЬНОСТЬ РАБОТЫ

CN 允许的日常运营周期

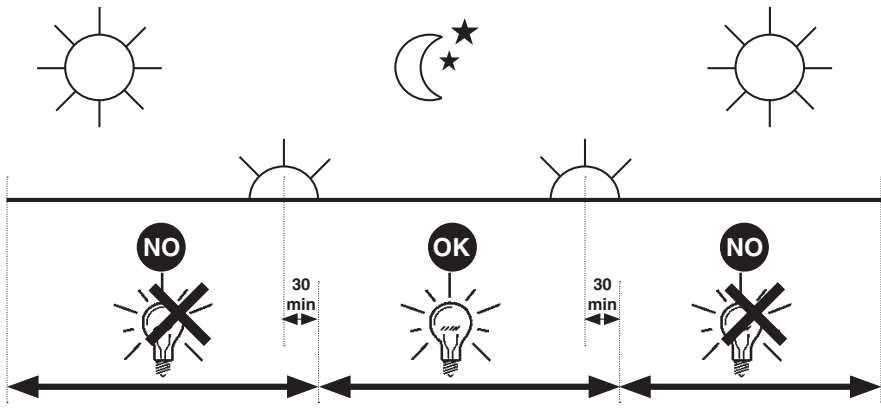

I PERIODO GIORNALIERO DI ACCENSIONE AMMESSO

iGuzzini

1.154.627.01
IS09175/01

GB ALLOWED DAILY OPERATION PERIOD

F DURÉE QUOTIDIENNE D'ALLUMAGE ADMISSIBLE

D ERLAUBTE TÄGLICHE EINSCHALTDAUER

NL DAGELIJKSE ONTSTEKINGSPERIODE TOEGESTAAN

E PERIODO DIARIO DE ENCENDIDO PERMITIDO

DK TILLADT TIDSRUM FOR DAGLIG TÆNDING

N TILLÄTT TENNINGSTID PR. DAG

S TILLÄTEN DAGLIG PERIOD SOM PRODUKTEN KAN VARA TÄND

RUS ЕЖЕДНЕВНАЯ ДОПУСТИМАЯ ПРОДОЛЖИТЕЛЬНОСТЬ РАБОТЫ

CN 允许的日常运营周期

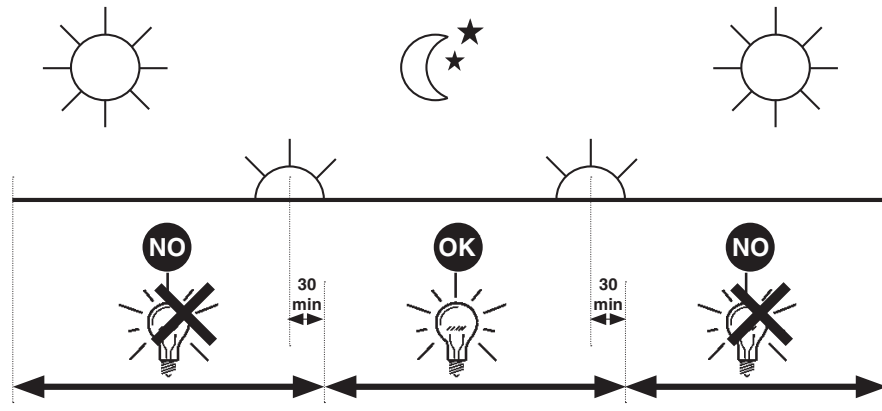

iGuzzini

2.509.386.00
ISO9176/01

الفترة الزمنية اليومية للتشغيل المسموح بها

- I PERIODO GIORNALIERO DI ACCENSIONE AMMESSO
- GB ALLOWED DAILY OPERATION PERIOD
- E PERIODO DIARIO DE ENCENDIDO PERMITIDO

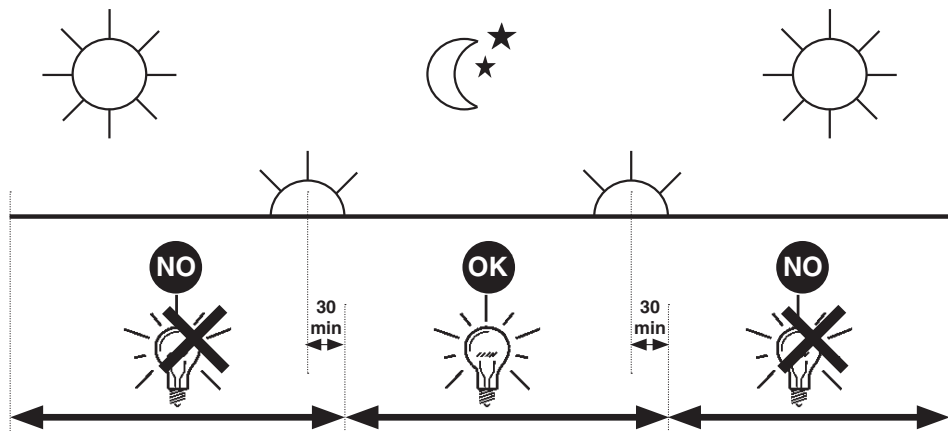

iGuzzini

2.509.386.00
ISO9176/01

الفترة الزمنية اليومية للتشغيل المسموح بها

- I PERIODO GIORNALIERO DI ACCENSIONE AMMESSO
- GB ALLOWED DAILY OPERATION PERIOD
- E PERIODO DIARIO DE ENCENDIDO PERMITIDO

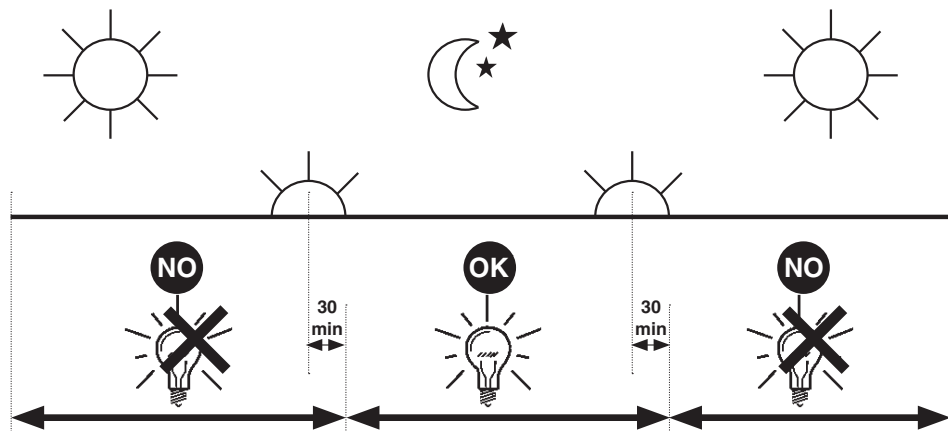

iGuzzini

2.509.386.00
ISO9176/01

الفترة الزمنية اليومية للتشغيل المسموح بها

- I PERIODO GIORNALIERO DI ACCENSIONE AMMESSO
- GB ALLOWED DAILY OPERATION PERIOD
- E PERIODO DIARIO DE ENCENDIDO PERMITIDO

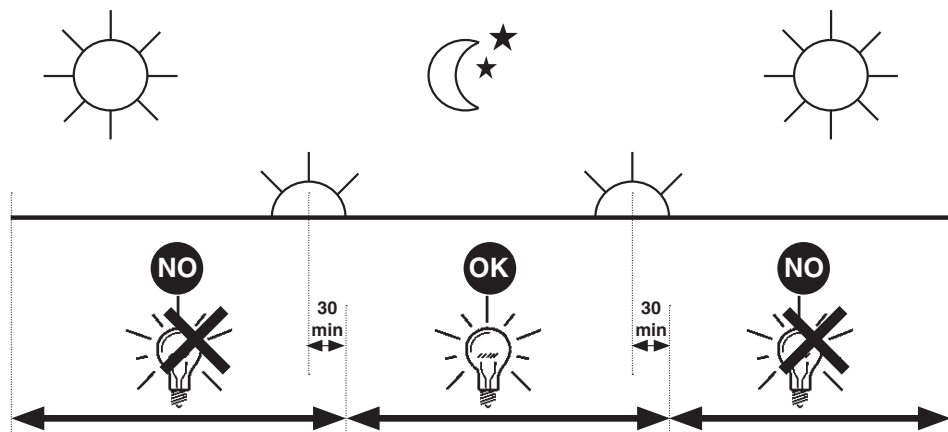

iGuzzini

2.509.386.00
ISO9176/01

الفترة الزمنية اليومية للتشغيل المسموح بها

- I PERIODO GIORNALIERO DI ACCENSIONE AMMESSO
- GB ALLOWED DAILY OPERATION PERIOD
- E PERIODO DIARIO DE ENCENDIDO PERMITIDO

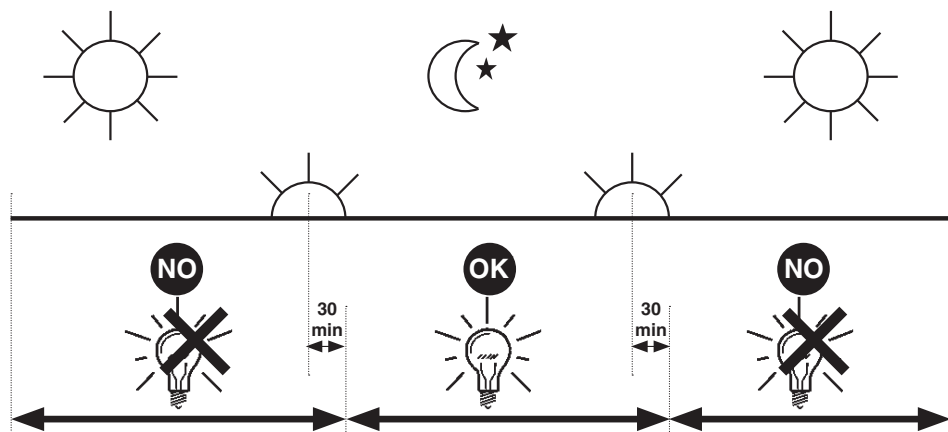

- I Istruzioni per le operazioni di servizio per l'apparecchio di illuminazione**
GB Instructions on luminaire service operations
F Instructions pour les opérations de service du luminaire
D Wartungsanleitung für die Leuchte
NL Instructies voor de onderhoudsoperaties op de verlichtingsarmatuur
E Instrucciones para las operaciones de servicio del aparato de alumbrado
DK Anvisninger i serviceindgreb på belysningsarmatur
N Anvisninger for betjening av lysapparatet
S Instruktioner för användning av belysningsanordningen
RUS Инструкции по эксплуатации осветительного прибора
CN 照明装置检修操作说明

Sostituire la lampada parzialmente esausta
 Replace the partly exhausted lamp
 Remplacer la lampe partiellement épuisée
 Die teilweise erschöpfte Lampe austauschen
 Vervang de gedeeltelijk lege lamp
 Sustituir la lámpara parzialmente agotada
 Udskift den delvist udtjente pære
 Skifte ut den delvis utbrente lyspæren
 Byt ut den delvis förbrukade lampan
 Замена частично отработанной лампочки
 更换部分老化的灯泡

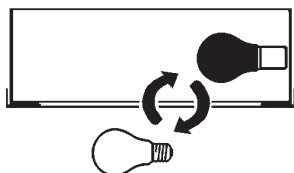

Spegnimento
 Switch it off
 Extinction
 Ausschaltung
 Uitschakeling
 Apagado
 Slukning
 Slukking
 Släckning
 Выключение
 关灯

Interrompere l'alimentazione dell'apparecchio
 Cut the power supply to the luminaire
 Couper l'alimentation du luminaire
 Stromversorgung der Leuchte unterbrechen
 Onderbreek de voeding van het apparaat
 Interrumpir la alimentación del aparato
 Afbryd armaturets strømforsyning
 Avbryte strømtilførselen til apparatet
 Koppla från anordningens strömförsörjning
 Отключить электропитание прибора
 中断装置供电

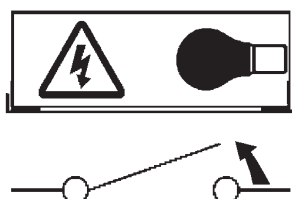

Aprire l'apparecchio
 Open the fixture
 Ouvrir le luminaire
 Das Gerät öffnen
 Open het apparaat
 Abrir el aparato
 Åbn armaturet
 Åpne apparatet
 Öppna anordningen
 Раскрыть прибор
 打开装置

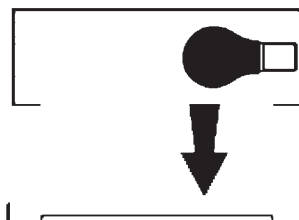

Rimuovere la lampada esausta
 Remove the exhausted lamp
 Retirer la lampe épuisée
 Die alte Lampe entnehmen
 Verwijder de lege lamp
 Quitar la lámpara agotada
 Tag den udtjente pære ud
 Fjerne den utbrente lyspæren
 Ta bort den förbrukade lampan
 Вынуть старую лампочку
 取出老化的灯泡

Portarla in un centro di riciclaggio
 Carry it to a recycling centre
 La porter dans une déchetterie pour son recyclage
 Ordnungsgemäß entsorgen
 Breng de lamp naar een recyclingcentrum
 Llevarla a un centro de reciclaje
 Aflever den på en genbrugsstation
 Lever den til en miljøstasjon
 Lämna in den till en återvinningsanläggning
 Сдать ее в пункт приема утильсырья
 将其送往回收中心

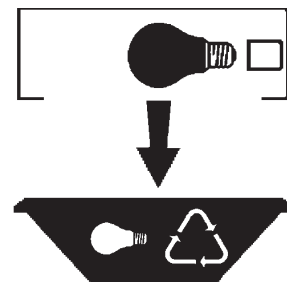

Inserire la nuova lampada
 Introduce the new lamp
 Installer la lampe neuve
 Die neue Lampe einsetzen
 Doe de nieuwe lamp op zijn plek
 Montar la nueva lámpara
 Sæt den nye pære i
 Sette i den nye pæren
 Sätt i den nya lampan
 Вставить новую лампочку
 装入新灯泡

Inserire la nuova lampada nel portalampada
 Fit the new lamp into the socket
 Installer la nouvelle lampe dans le support de lampe
 Die neue Lampe in den Sockel einsetzen
 Doe de nieuwe lamp in de lamphouder
 Montar la nueva lámpara en el portalámpara
 Sæt den nye pære i fatningen
 Sette den nye pæren inn i lampeholderen
 Sätt i den nya lampan i lamphållaren
 Вставить новую лампочку в патрон
 将新灯泡插入灯泡架中

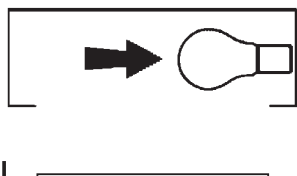

Riposizionare ottica
 Re-place the optic
 Remettre l'optique à sa place
 Die Optik wieder einsetzen
 Doe de optiek weer op zijn plaats
 Volver a montar la óptica
 Sæt den optiske enhed på plads
 Innstille linsen
 Flytta om optiken
 Отрегулировать линзы
 重新定位光头

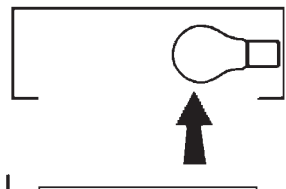

Effettuare prova di funzionamento
 Perform operative test
 Procéder à un essai de fonctionnement
 Eine Funktionsprüfung durchführen
 Controleer de correcte werking
 Hacer una prueba de funcionamiento
 Afprøv funktionen
 Prøve om den fungerer
 Utför funktionstest
 Выполнить проверку исправности работы
 执行功能测试

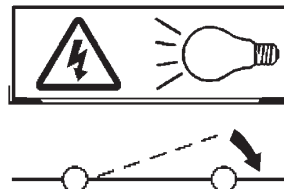

I Istruzioni per la pulizia dell'apparecchio di illuminazione
GB Instructions on luminaire cleaning operations
F Instructions pour le nettoyage du luminaire
D Anweisungen zur Reinigung der Leuchte
NL Instructies voor de reiniging van de verlichtingsarmatuur
E Instrucciones para limpiar el aparato de alumbrado
DK Anvisninger i rengøring af belysningsarmaturet
N Anvisninger for rengjøring av lysapparatet
S Instruktioner för rengöring av belysningsanordningen
RUS Инструкции по чистке осветительного прибора
CN 照明装置清洁说明

Pulire l'apparecchio
Clean the fixture
Nettoyer le luminaire
Das Gerät reinigen
Reinig het apparaat
Limpiar el aparato
Rengør armaturet
Rengjøre apparatet
Rengör anordningen
Чистка прибора
清洁装置

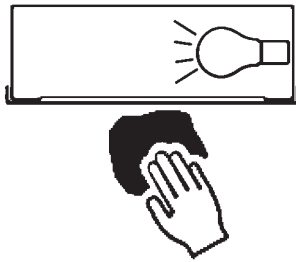

Spegnimento
Switch it off
Extinction
Ausschaltung
Uitschakeling
Apagado
Slukning
Slukking
Släckning
Выключение
关灯

Interrompere l'alimentazione dell'apparecchio
Cut the power supply to the luminaire
Couper l'alimentation du luminaire
Stromversorgung der Leuchte unterbrechen
Onderbreek de voeding van het apparaat
Interrumpir la alimentación del aparato
Afbryd armaturets strømforsyning
Avbryt strømtilførselen til apparatet
Koppla från anordningens strömförsörjning
Отключить электропитание прибора
中断装置供电



Spolverare l'ottica esterna
Remove dust from the external optic
Dépoussiérer l'optique extérieure
Die externe Optik abstauben
Stof de externe optiek af
Quitar el polvo de la óptica exterior
Tør støvet af den udvendige optiske enhed
Fjerne støv fra den eksterne lysenheten
Damma av den yttre optiken
Вытереть пыль с внешней стороны линз
为外侧光头掸尘

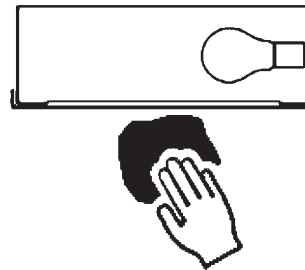

Lavare l'ottica esterna
Wash the external optic
Laver l'optique extérieure
Die externe Optik waschen
Was de externe optiek
Lavar la óptica exterior
Vask den udvendige optiske enhed
Vaske den eksterne lysenheten
Rengör den yttre optiken
Вымыть линзы с внешней стороны
清洁外光头

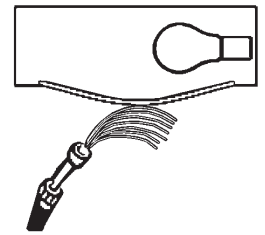

Rimuovere l'ottica
Remove the optic
Retirer l'optique
Die Optik abnehmen
Verwijder de optiek
Quitar la óptica
Tag den optiske enhed af
Fjerne lysenheten
Ta bort optiken
Снять линзы
取下光头

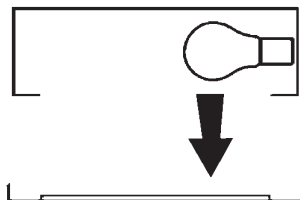

Pulire la parte interna dell'apparecchio di illuminazione
Clean the inside of the fixture
Nettoyer l'intérieur du luminaire
Die Innenseite der Leuchte reinigen
Reinig de binnenzijde van de verlichtingsarmatuur
Limpiar el interior del aparato de alumbrado
Rengør belysningsarmaturets indvendige dele
Rengjøre lysapparatet innvendig
Rengör belysningsanordningen invändigt
Протереть осветительный прибор изнутри
清洁照明装置内部



Riposizionare ottica
Re-place the optic
Remettre l'optique à sa place
Die Optik wieder einsetzen
Doe de optiek weer op zijn plaats
Volver a montar la óptica
Sæt den optiske enhed på plads
Innstille linsen
Flytta om optiken
Отрегулировать линзы
重新定位光头

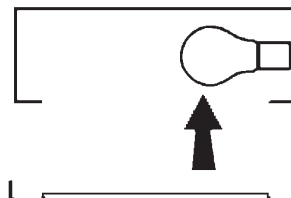

Effettuare prova di funzionamento
Perform operative test
Procéder à un essai de fonctionnement
Eine Funktionsprüfung durchführen
Controleer de correcte werking
Hacer una prueba de funcionamiento
Afprøv funktionen
Prøve om den fungerer
Utför funktionstest
Выполнить проверку исправности работы
执行功能测试

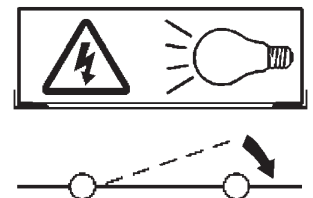

- I Istruzioni per il fine vita e lo smaltimento dei componenti**
GB Instructions on end-of-life and component disposal
F Instructions pour la gestion des composants en fin de vie et leur mise au rebut
D Anweisungen zur Entsorgung der Leuchtenkomponenten
NL Instructies voor het verwijderen van de armatuur en het recyclen van de onderdelen
E Instrucciones para el final de vida y la eliminación los componentes
DK Anvisninger i udtjent armatur og bortskaffelse af komponenter
N Anvisninger for endt levetid og avfallsbehandling av delene
S Instruktioner vid bortskaffning och kassering av komponenter
RUS Инструкции по утилизации прибора и его комплектующих по окончании его срока службы
CN 寿命期结束与零件废弃处置说明

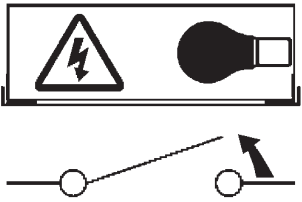
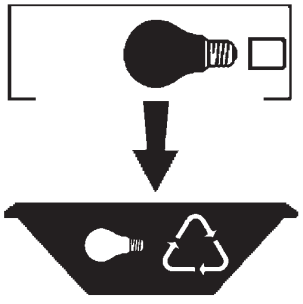
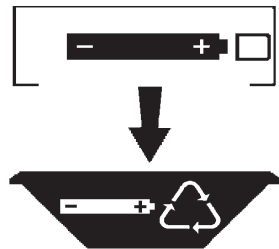
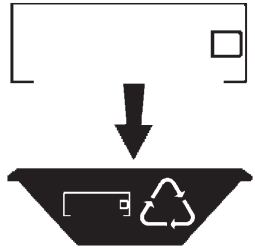
<p>Spegnimento Switch it off Extinction Ausschaltung Uitschakeling Apagado Slukning Slukking Släckning Выключение 关灯</p> <p>Interrompere l'alimentazione dell'apparecchio Cut the power supply to the luminaire Couper l'alimentation du luminaire Stromversorgung der Leuchte unterbrechen Onderbreek de voeding van het apparaat Interrompirla alimentación del aparato Afbryd armaturets strømforsyning Avbryt strømtilførselen til apparatet Koppla från anordningens strömförsörjning Отключить электропитание прибора 中断装置供电</p> 	<p>Rimuovere la/e lampada/e per la dismissione Remove the lamp(s) for decommissioning Retirer la(les) lampe(s) pour sa(leur) mise au rebut Die Lampe/n ordnungsgemäß entsorgen Verwijder de lamp(en) voor het recyclen Quitar la(s) lámpara(s) para el desecho Tag pæren/pærerne ud til bortskaffelse Fjerne lampen/-e som skal kastes Ta bort lampan/-orna för bortskaffningen Вынуть лампочку/и для утилизации прибора 取出需要丢弃的灯泡</p> 	<p>Rimuovere la batteria per la dismissione Remove the battery for decommissioning Retirer la batterie pour sa mise au rebut Die Batterie ordnungsgemäß entsorgen Verwijder de batterij voor het recyclen Quitar la batería para el desecho Tag batteriet ud til bortskaffelse Fjerne batteriet som skal kastes Ta bort batteriet för bortskaffningen Вынуть батарейку для утилизации прибора 取出需要丢弃的电池</p> 	<p>Rimuovere l'apparecchio per la dismissione Remove the fixture for decommissioning Enlever le luminaire pour sa mise au rebut Das Gerät ordnungsgemäß entsorgen Verwijder het apparaat voor het recyclen Quitar el aparato para el desecho Tag armaturet ud til bortskaffelse Fjerne apparatet som skal kastes Ta bort anordningen för bortskaffningen Снять прибор для утилизации 取出需要丢弃的装置</p> 
---	--	--	--

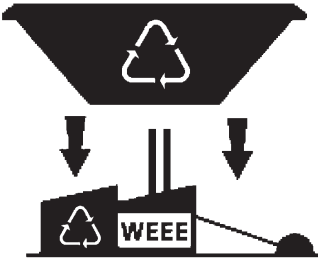
<p>Inviare i materiali ad un centro di raccolta RAEE Send the materials to a WEEE collection centre Envoyer les matériaux dans une déchetterie DEEE Die Materialien in einem WEEE-Zentrum entsorgen Zend de materialen naar een recyclingscentrum voor de AEEA Enviar los materiales a un centro de recogida RAEE Afløver materialerne på et indsamlingscenter for elektronisk udstyr Sende materialene til en miljøstasjon for resirkulering av EE-avfall Skicka materialet till en RAEE uppsamlingscentral Сдать материалы в пункт приема утильсырья 将材料送往电气和电子垃圾回收中心</p> 			
--	--	--	--