



ATTENZIONE:

LA SICUREZZA DELL'APPARECCHIO E' GARANTITA SOLO CON L'USO APPROPRIATO DELLE SEGUENTI ISTRUZIONI; PERTANTO E' NECESSARIO CONSERVARLE.

WARNING:

THE SAFETY OF THIS FIXTURE IS GUARANTEED ONLY IF YOU COMPLY WITH THESE INSTRUCTIONS; REMEMBER TO CONSERVE IN A SAFE PLACE.

ATTENTION:

LA SECURITE DEL'APPAREIL N'EST GARANTIE QU'ENCAS D'UTILISATION CORRECTE DES INSTRUCTIONS SUIVANTES; IL FAUT PAR CONSEQUENT LES CONSERVER.

ACHTUNG:

DIE SICHERHEIT DES GERÄTES WIRD NUR DURCH SACHGEMÄSSE BEFOLGUNG NACHSTEHENDER ANWEISUNGEN GEWÄHRLEISTET; IHRE AUFBEWAHRUNG IST DESHALB SEHR WICHTIG.

OPGELET:

DE VEILIGHEID VAN DIA TOESTEL IS SLECHTS DAN GEGARANDEERD ALS INDIEN DE VOLGENDE INSTRUCTIES STRIKT WORDEN TOEGEPAST; DAAROM MOET MEN ZE OOK BEWAREN.

ATENCION:

LA SEGURIDAD DEL APARATO SE GARANTIZA SOLO CUMPLIENDO CUIDADOSAMENTE LAS SIGUIENTES INSTRUCCIONES; POR ELLO, ES NECESARIO CONSERVARLAS.

BEMÆRK:

SIKKERHEDEN VED BRUG AF ARMATURET KAN KUN GARANTERES, HVIS DISSE ANVISNINGER FØLGES; SØRG DERFOR FOR AT GEMME DEM.

ADVARSEL:

SIKKERHETEN TIL DETTE APPARATET GARANTERES KUN HVIS DU OVERHOLDER DISSE INSTRUKSJONENE; HUSK Å OPPBEVARE DEM PÅ ET TRYGT STED.

OBSERVERA!

UTRUSTNINGENS SÄKERHET KAN ENDAST GARANTERAS OM DESSA ANVISNINGAR RESPEKTERAS I DETALJ. SPARA DÄRFÖR DESSA ANVISNINGAR FÖR FRAMTIDA KONSULTATION.

ВНИМАНИЕ:

МЫ ГАРАНТИРУЕМ БЕЗОПАСНУЮ ЭКСПЛУАТАЦИЮ ИЗДЕЛИЯ ТОЛЬКО ПРИ СОБЛЮДЕНИИ СЛЕДУЮЩИХ ИНСТРУКЦИЙ; С ЭТОЙ ЦЕЛЬЮ НЕОБХОДИМО СОХРАНИТЬ ДАННУЮ БРОШЮРУ.

警告:

为确保该装置安全，请遵守操作指示，并于安全场所放置。

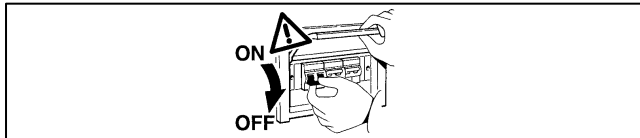

N.B.: DURANTE L'INSTALLAZIONE DEL SISTEMA "iRoll 65" RISPETTARE SCRUPOLOSAMENTE LE NORME IMPIANTISTICHE VIGENTI.

N.B.: WHEN INSTALLING THE SYSTEM "iRoll 65", STRICTLY COMPLY WITH ALL REGULATIONS ON INSTALLATION IN FORCE.

N.B.: LORS DE L'INSTALLATION DU SYSTÈME "iRoll 65" VEUILLEZ RESPECTER RIGOREUSEMENT LES NORMES EN VIGUEUR EN LA MATIÈRE.

NB: BEACHTEN SIE BEI DER INSTALLATION DES SYSTEMS "iRoll 65" GEWISSENHAFT DIE GÜLTIGEN BESTIMMUNGEN BEZÜGLICH DER ANLAGENTECHNIK.

N.B.: BIJ HET INSTALLEREN VAN HET iRoll 65 SYSTEEM MOET U DE GELDENDE INSTALLATIENORMEN STRIKT NALEVEN.

N.B.: DURANTE LA INSTALACIÓN DEL SISTEMA "iRoll 65" RESPETAR ESCRUPULOSAMENTE LAS NORMAS DE INSTALACIÓN VIGENTES.

N.B.: UNDER INSTALLATION AF "iRoll 65" SYSTEMET SKAL MAN NØJJE OVERHOLDE DE GÆLDENDE REGLER FOR DISSE ANLÆG.

N.B.: VED INSTALLASJON AV SYSTEMET "iRoll 65" SKAL ALLE FORSKRIFTER OM INSTALLASJON SOM GJELDER FØLGES STRENGT.

OBS! UNDER INSTALLATIONEN AV SYSTEMET "iRoll 65" SKA INSTALLATIONSFÖRESKRIFTERNA RESPEKTERAS I DETALJ.

ПРИМЕЧАНИЕ: В ПРОЦЕССЕ МОНТАЖА СИСТЕМЫ "iRoll 65" СТРОГО СОБЛЮДАЙТЕ ДЕЙСТВУЮЩИЕ НОРМАТИВЫ ПО ЭЛЕКТРОПРОВОДКЕ.

注意：安装 "iRoll 65" 系统时，请严格遵守所有现行安装规定。

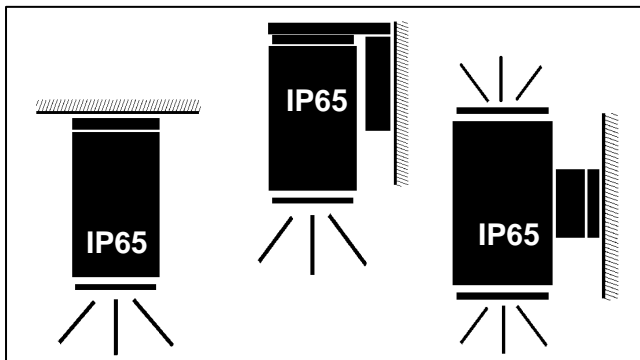

- I Posizioni d'installazione diverse da quelle indicate non sono consentite.
- GB Installation positions different to those indicated are not allowed.
- F Aucune autre position d'installation que celles indiquées n'est permise.
- D Andere als die angegebenen Positionen für die Installation sind nicht zugelassen.
- NL Het is niet toegestaan de apparaten op een andere manier te installeren dan aangegeven.
- E No se permiten posiciones de instalación diferentes de las indicadas.
- N Installasjonsstillinger bortsett fra de som angis, er ikke tillatt.
- DK Andre installationstyper og -positioner end de angivne er ikke tilladt.
- S Andra installationspositioner än de som föreskrivs är inte tillåtna.
- RUS Не допускается монтажное положение, отличное от указанного в настоящем тех. руководстве.
- CN 安装在与指定位置不同的地方是不被允许的。

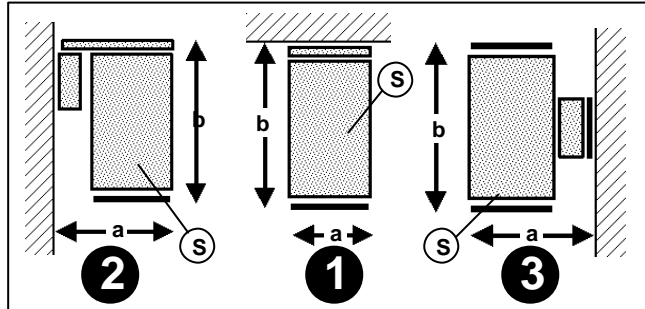
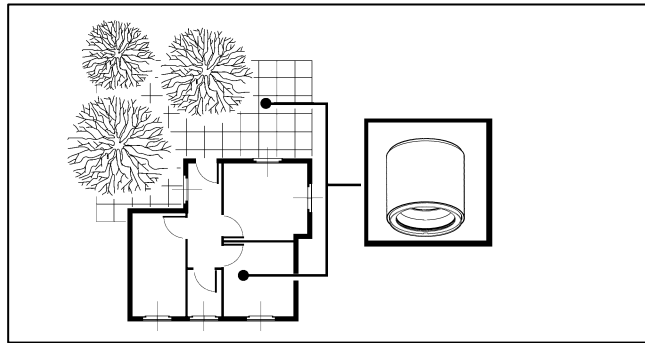

| ART | (KG) | a x b (mm) | (mq) |
|--|------|------------|--------|
| 1 BA79 - BA80 BA81 - BA82 BA83 - BA84 | 0,6 | 78 x 124 | 0,0095 |
| 2 BA85 - BA86 BA87 - BA88 BA89 - BA90 | 0,7 | 96 x 126 | 0,011 |
| 3 BA91 - BA92 BA93 - BA94 BA95 - BA96 | 0,9 | 117 x 134 | 0,013 |

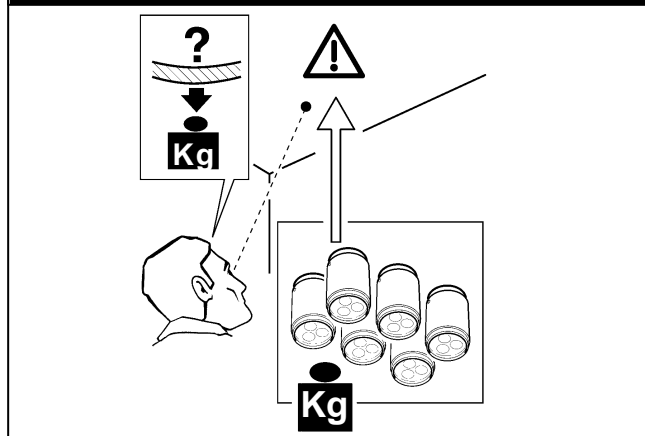

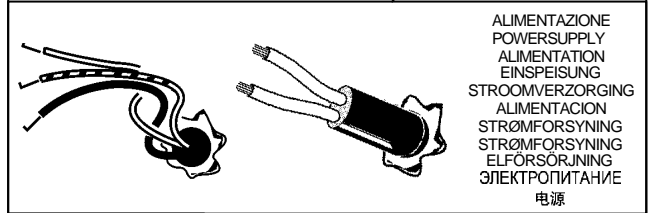
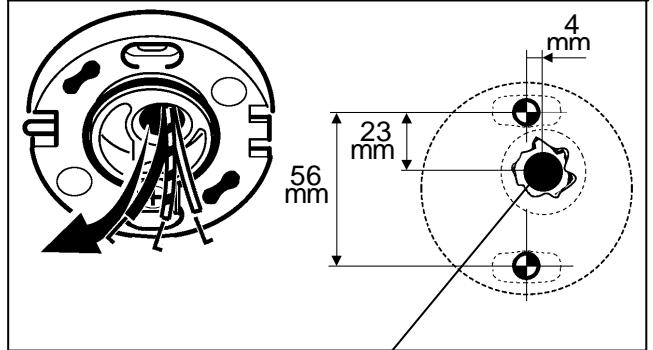
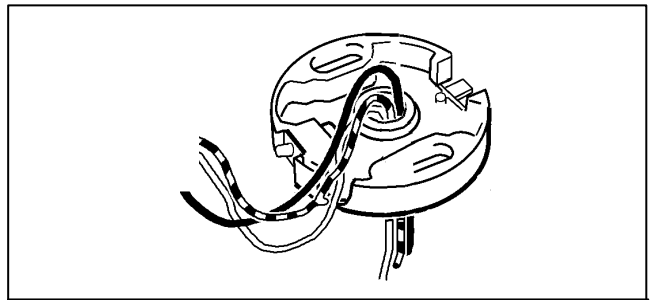
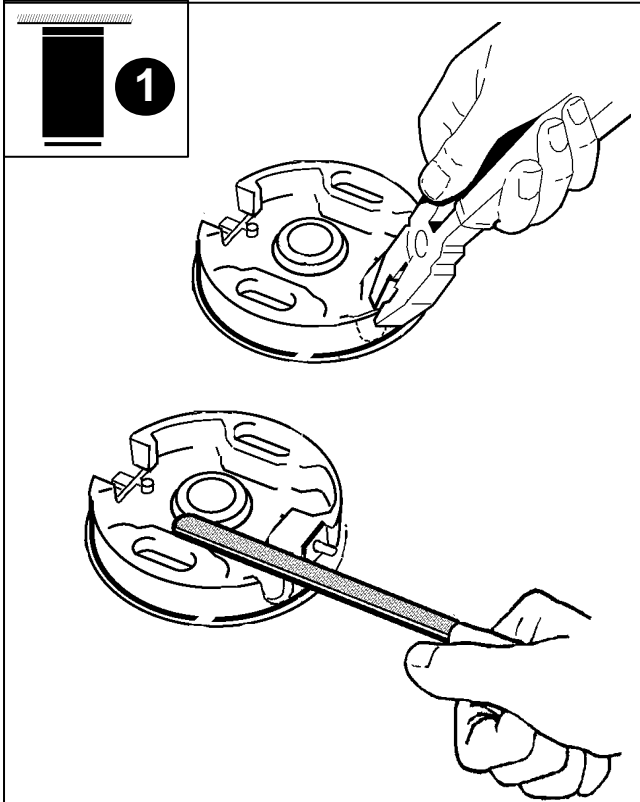
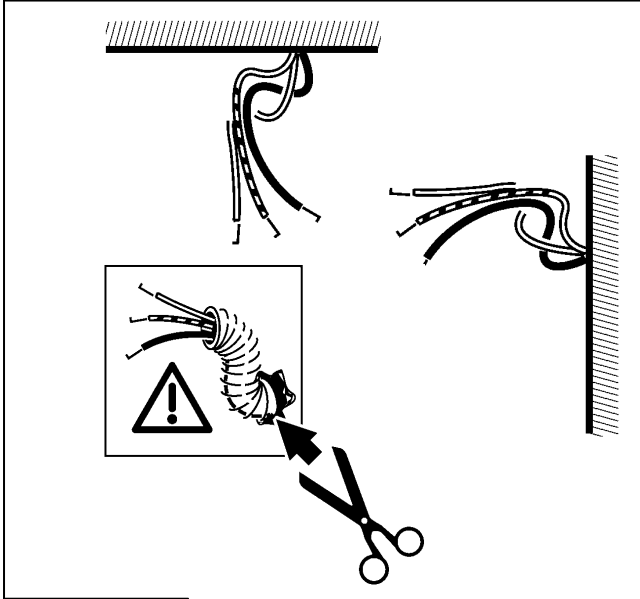
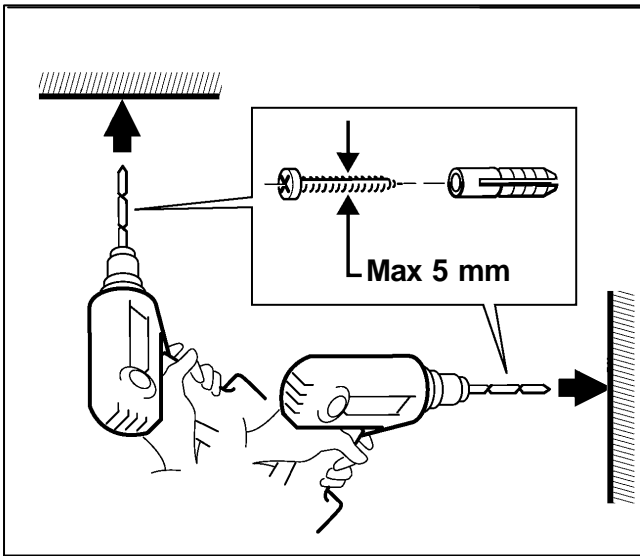

ALIMENTAZIONE
 POWERSUPPLY
 ALIMENTATION
 EINSPEISUNG
 STROOMVERZORGING
 ALIMENTACION
 STRØMFORSYNING
 STRØMFORSYNING
 ELFÖRSÖRJNING
 ЭЛЕКТРОПИТАНИЕ
 电源

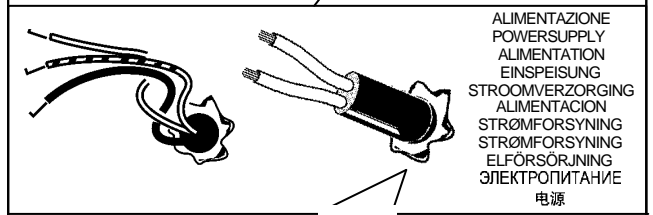
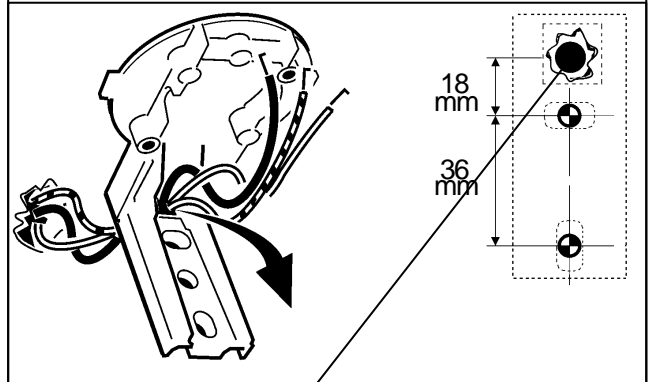
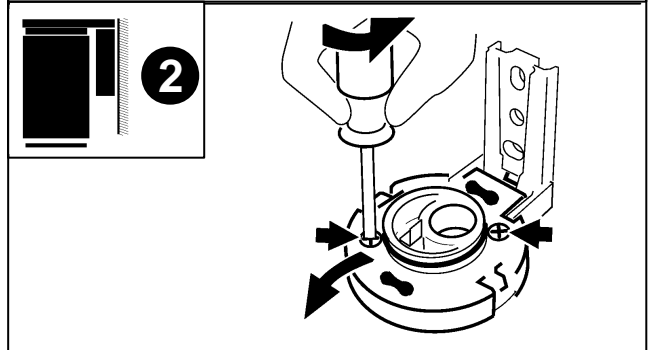

ALIMENTAZIONE
 POWERSUPPLY
 ALIMENTATION
 EINSPEISUNG
 STROOMVERZORGING
 ALIMENTACION
 STRØMFORSYNING
 STRØMFORSYNING
 ELFÖRSÖRJNING
 ЭЛЕКТРОПИТАНИЕ
 电源

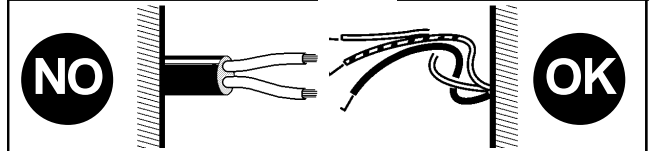

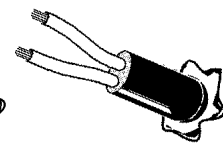
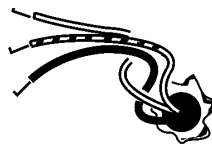
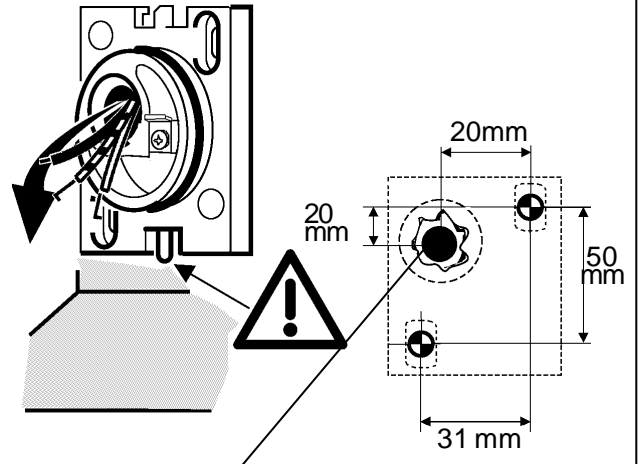
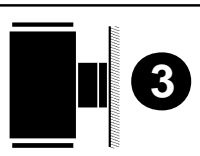
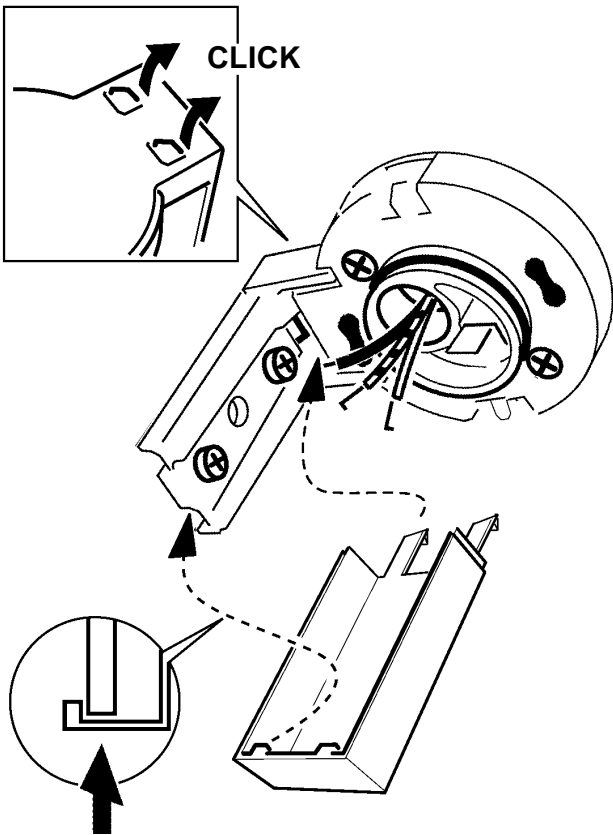
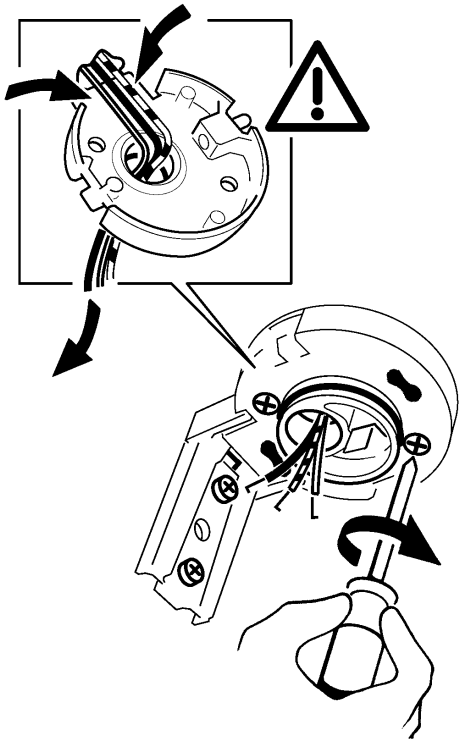

ALIMENTAZIONE
 POWERSUPPLY
 ALIMENTATION
 EINSPEISUNG
 STROOMVERZORGING
 ALIMENTACION
 STRØMFORSYNING
 STRØMFORSYNING
 ELFÖRSÖRJNING
 ЭЛЕКТРОПИТАНИЕ
 电源

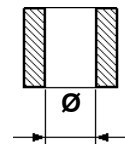
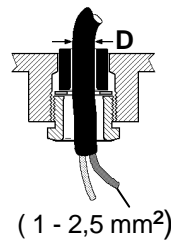
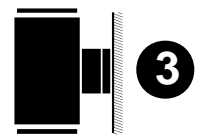
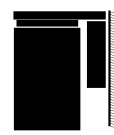
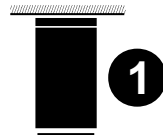

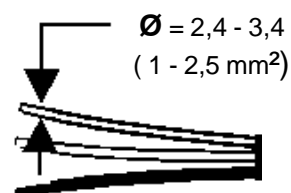
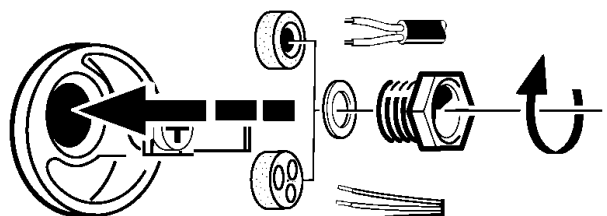

| D (mm) | Ø (mm) |
|-----------|-----------|
| 6,5 ÷ 9 | 8 |
| 9 ÷ 11,5 | 10,5 |

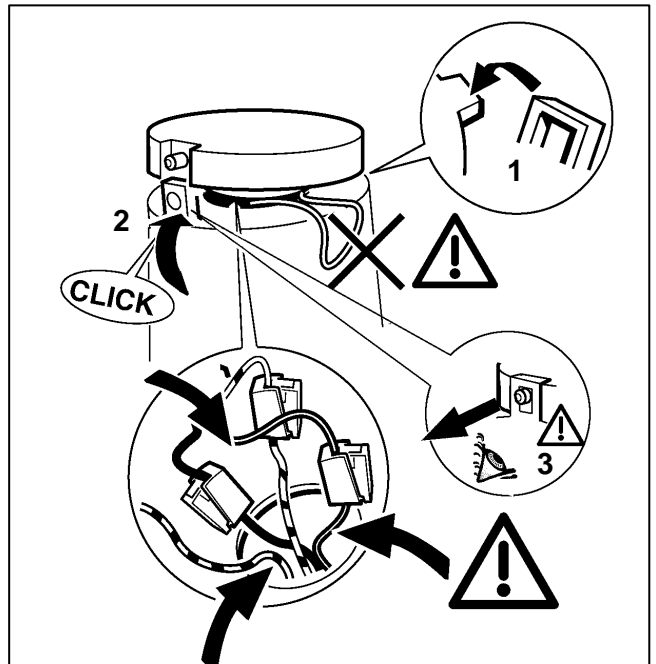
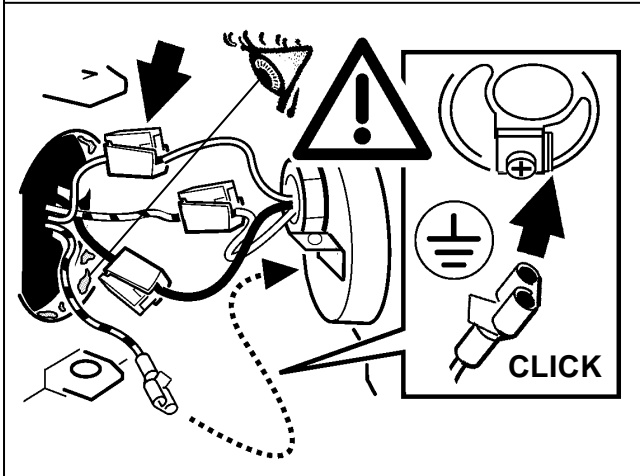
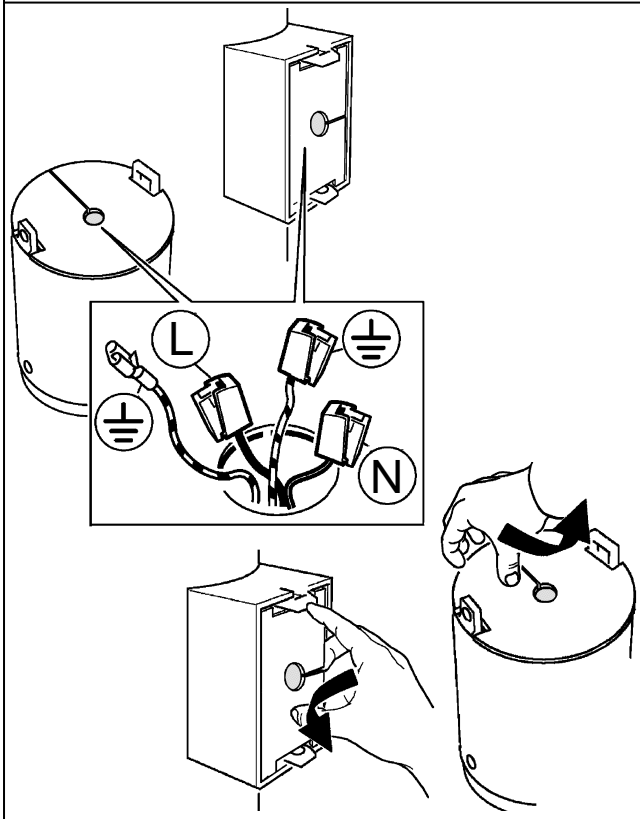
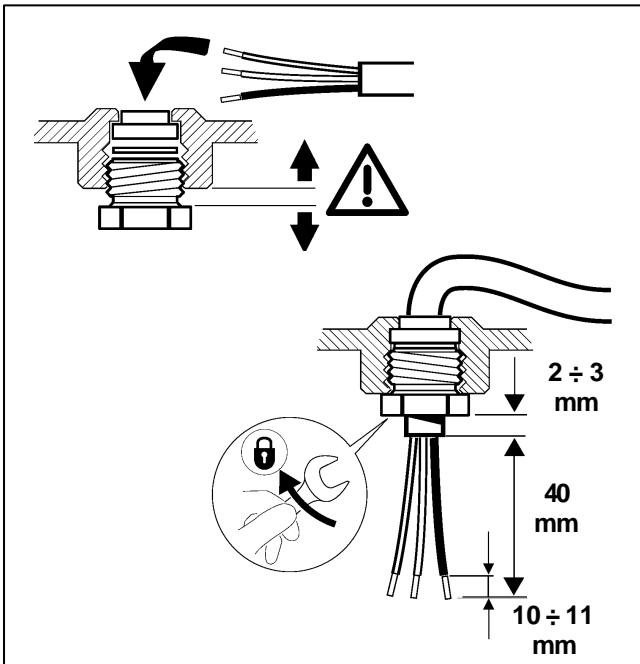



art. BZ17 - BZ18 - BZ19

| ART |  art. |  art. |  art. |
|--|---|---|---|
| BA79 - BA80 BA82 - BA83 BA85 - BA86 BA88 - BA89 BA91 - BA92 BA94 - BA95 | BZ17 | BZ19 | BZ18 |
| BA81 - BA84 BA87 - BA90 BA93 - BA96 | BZ17 | BZ19 | - |

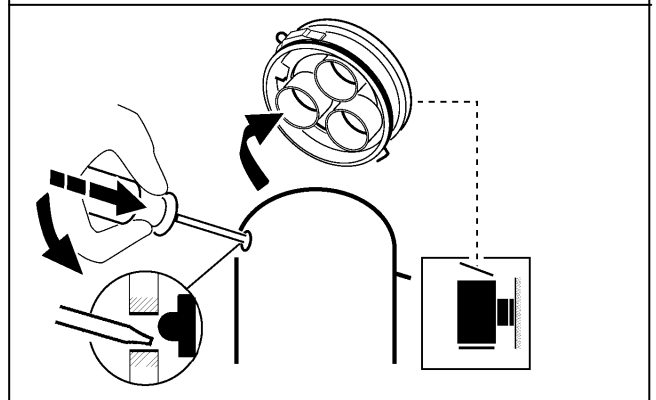
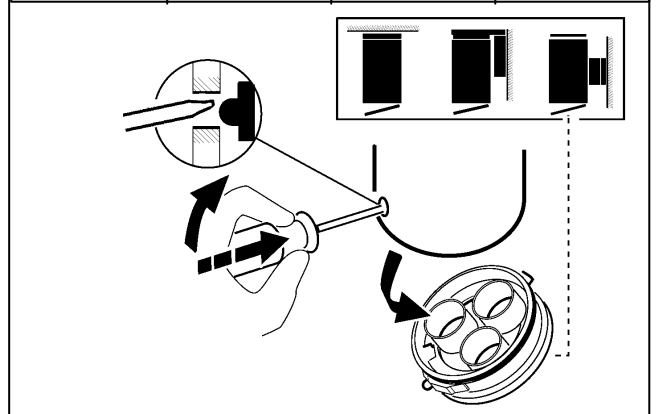

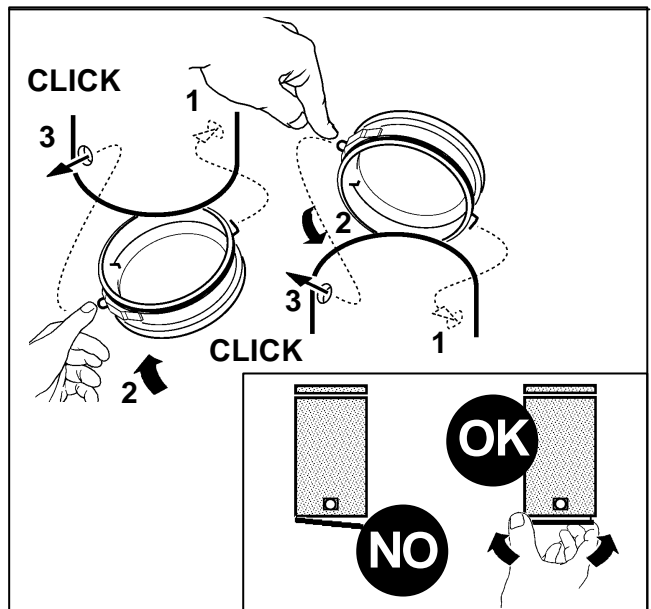
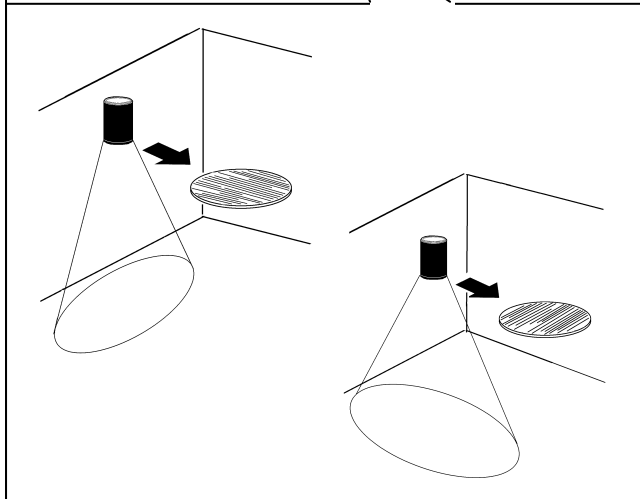
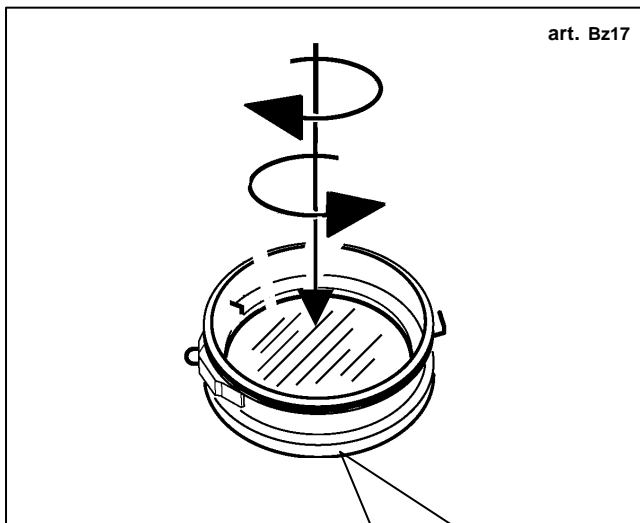
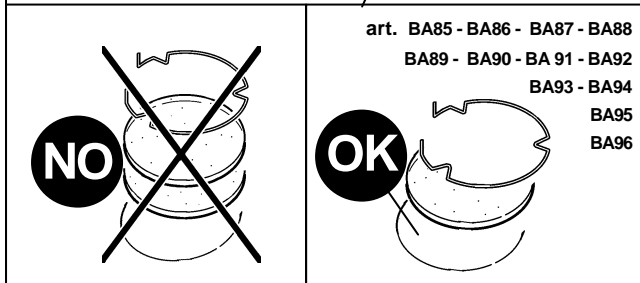
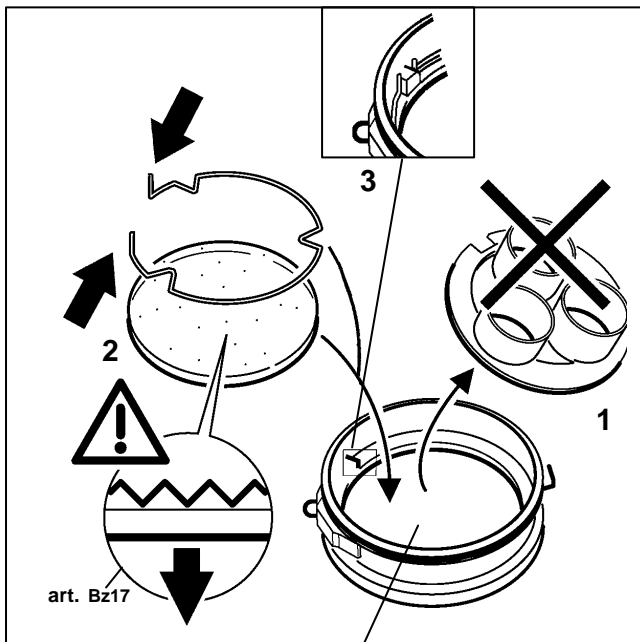

SOSTITUZIONE DEL LED
REPLACING THE LED
REPLACEMENT DE LA LED
AUSTAUSCHENDER LED
VERVANGEN VAN DE LED
REEMPLAZO DEL LED
UDSKIFTNING AF LYSDIODE
BYTJE AV LYSDIOD
UTSKIFTING AV DEN LYSSEMITTERENDE DIODEN
发光二极管替换

- I N.B.:** Per la sostituzione del LED contattare l'azienda iGuzzini.
- GB N.B.:** For information on LED replacement please contact iGuzzini.
- F N.B.:** Pour procéder au remplacement de la LED, adressez-vous à la société iGuzzini.
- D N.B.:** Bezüglich des Austausches der LED kontaktieren Sie bitte die Firma iGuzzini.
- NL N.B.:** Voor het vervangen van de LED neemt u contact op met het bedrijf iGuzzini.
- E NOTA:** Para sustituir el LED llame a la empresa iGuzzini.
- DK N.B.:** For udsiftning af lysdioden, skal man kontakte iGuzzini.
- N N.B.:** For informasjon om skifte av LED, vennligst ta kontakt med iGuzzini.
- S OBS!** För byte av lysdioden, kontakta företaget iGuzzini.
- RUS ПРИМЕЧАНИЕ:** Для замены СИДов обращайтесь в компанию iGuzzini.
- CN 注意:** 如需LED更换的信息, 请联系iGuzzini.

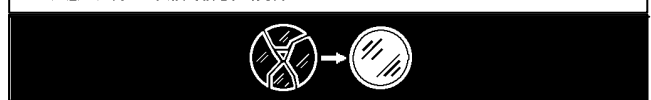

VETRO SODICO-CALCICO TEMPRATO
TEMPERED SODA-LIME GLASS
VERRE SODIQUE-CALCIQUE TEMPRÉ
NATRIUM-KALZIUM-GLAS
GETEMPERD NATRIUMKALKGLAS
CRISTAL SÓDICO-CALCÁREO TEMPLADO
HÆRDET NATRONKALKGLAS
TEMPERERT KALK-NATRON-GLASS
HÅRDAT KALK-SODAGLAS
ЗАКАЛЕННОЕ НАТРИЕВО-КАЛЬЦИЕВОЕ СТЕКЛО
钢化钙钠玻璃

- I** In caso di rottura del vetro il prodotto non può essere utilizzato, contattare il costruttore per la sua sostituzione.
- GB** Should the glass break, the product cannot be used and you should contact the manufacturer for its replacement.
- F** En cas d'endommagement de l'écran de protection le produit ne peut pas être utilisé, contactez le fabricant pour le remplacement.
- D** Falls das Glas kaputt sein sollte, kann das Produkt nicht verwendet werden. Kontaktieren Sie in dem Fall den Hersteller, um das Glas zu ersetzen.
- NL** Als het glas gebroken is kan het apparaat niet worden gebruikt en moet u zich tot de fabrikant wenden voor het vervangen van het glas.
- E** No utilizar el producto en caso de ruptura del vidrio y contactar el fabricante para la sustitución.
- DK** Hvis produktets glas ødelægges, kan det ikke anvendes. Kontakt forhandleren med henblik på udsiftning.
- N** Hvis glasset skulle knuses, kan ikke produktet brukes, og du må ta kontakt med produsenten for å få det skiftet.
- S** Om glaset går sönder kan inte produkten användas. Kontakta tillverkaren för att byta ut glaset.
- RUS** В случае разбивания стекла не используйте прибор, обратитесь к его производителю для замены. GB
- CN** 一旦玻璃破碎后产品将不能再使用, 须联系生产商予以更换.

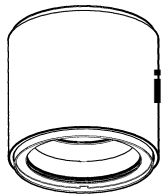

iRoll 65 corpo micro

تحذير:

لا يمكن ضمان سلامة هذا الجهاز إلا إذا التزمت بهذه التعليمات. يجب حفظها في مكان آمن.

ATTENZIONE:

LA SICUREZZA DELL'APPARECCHIO E GARANTITA SOLO CON L'USO APPROPRIATO DELLE SEGUENTI ISTRUZIONI; PERTANTO E' NECESSARIO CONSERVARLE.

WARNING:

THE SAFETY OF THIS FIXTURE IS GUARANTEED ONLY IF YOU COMPLY WITH THESE INSTRUCTIONS; REMEMBER TO CONSERVE IN A SAFE PLACE.

ATENCIÓN:

LA SEGURIDAD DEL APARATO SE GARANTIZA SOLO CUMPLIENDO CUIDADOSAMENTE LAS SIGUIENTES INSTRUCCIONES; POR ELLO, ES NECESARIO CONSERVARLAS.

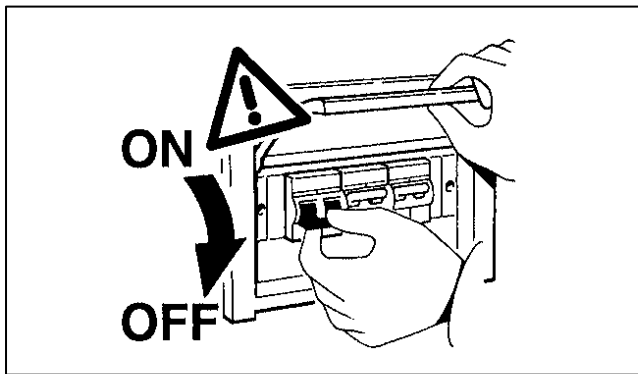

ملاحظة: ملاحظة: أثناء تركيب نظام "iRoll 65"، يجب النقيد بحرص بالنظم السائدة المتعلقة بالشبكة الكهربائية.

N.B.: DURANTE L'INSTALLAZIONE DEL SISTEMA "iRoll 65" RISPETTARE SCRUPOLOSAMENTE LE NORME IMPIANTISTICHE VIGENTI.

N.B.: WHEN INSTALLING THE SYSTEM "iRoll 65", STRICTLY COMPLY WITH ALL REGULATIONS ON INSTALLATION IN FORCE.

N.B.: DURANTE LA INSTALACIÓN DEL SISTEMA "iRoll 65" RESPETARE SCRUPULOSAMENTE LAS NORMAS DE INSTALACIÓN VIGENTES.

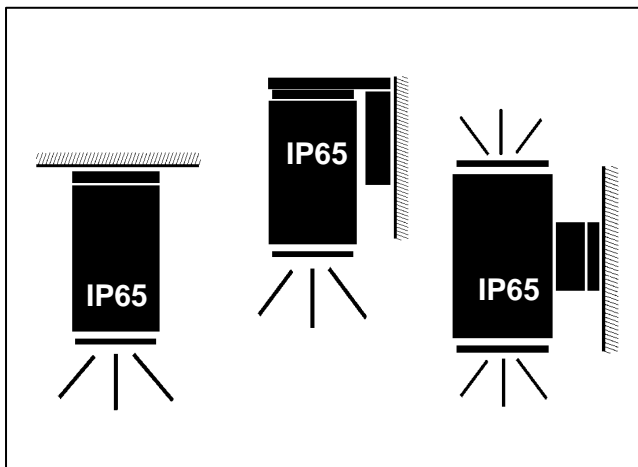

عر مواضع التركيب المختلفة عن المواضع المبينة غير مسموح بها.

I Posizioni d'installazione diverse da quelle indicate non sono consentite.

GB Installation positions different to those indicated are not allowed.

E No se permiten posiciones de instalación diferentes de las indicadas.

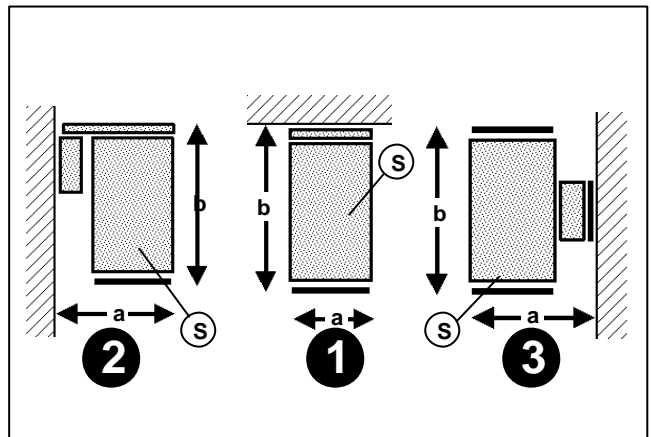
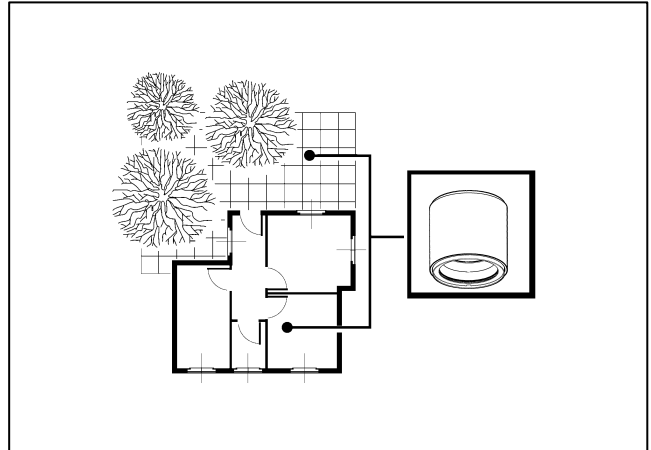

| الصفيف ART | الوزن (KG) | القياسات a x b (mm) | المساحة (mq) |
|--|---------------|---------------------------|-----------------|
| 1 BA79 - BA80 BA81 - BA82 BA83 - BA84 | 0,6 | 78 x 124 | 0,0095 |
| 2 BA85 - BA86 BA87 - BA88 BA89 - BA90 | 0,7 | 96 x 126 | 0,011 |
| 3 BA91 - BA92 BA93 - BA94 BA95 - BA96 | 0,9 | 117 x 134 | 0,013 |

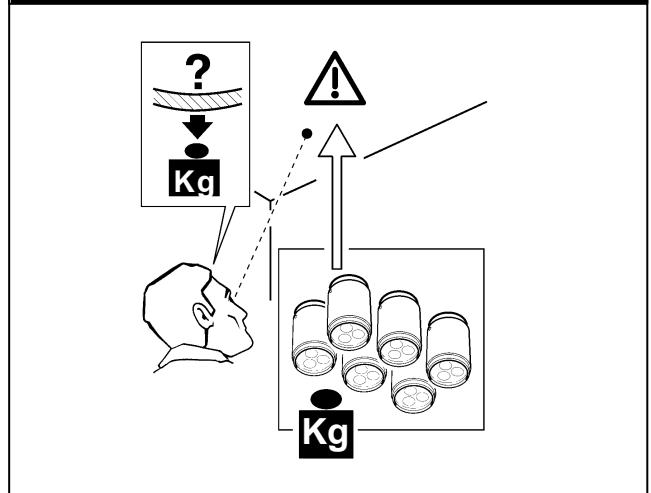
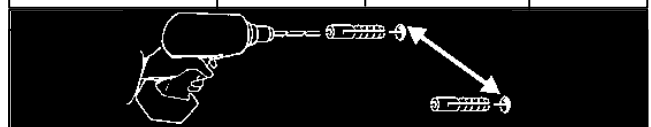

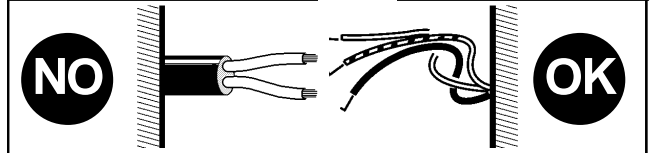
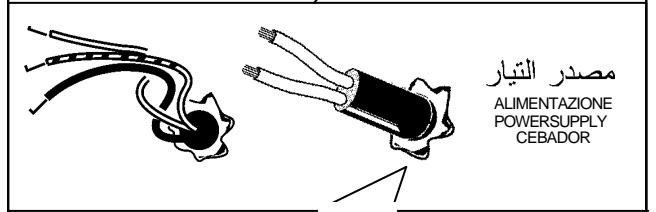
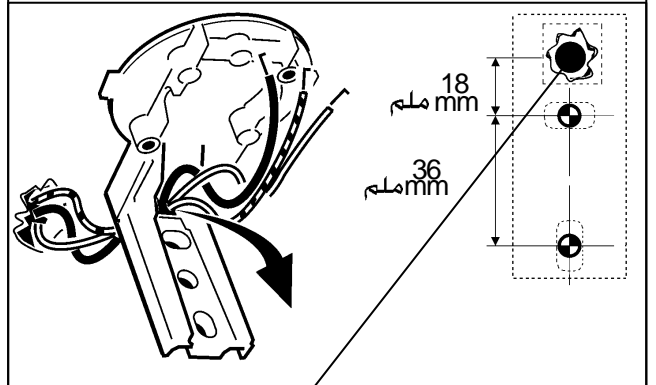
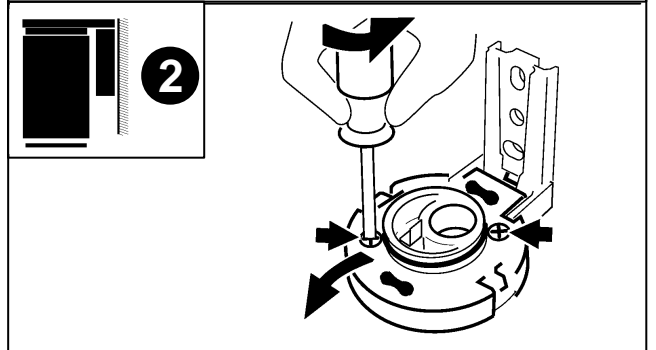
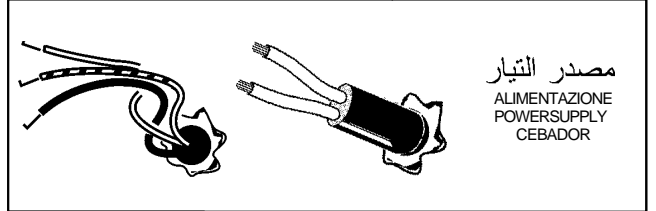
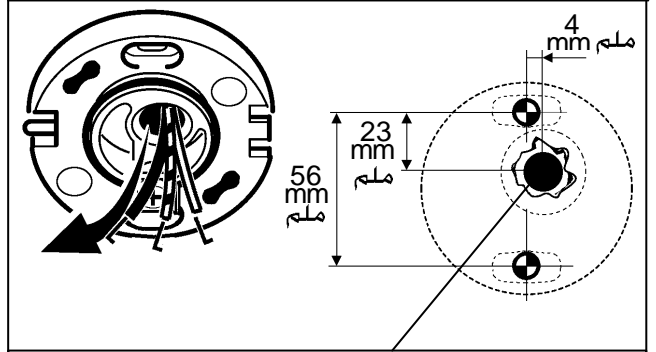
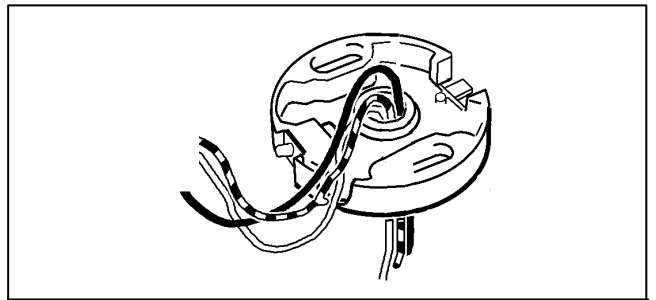
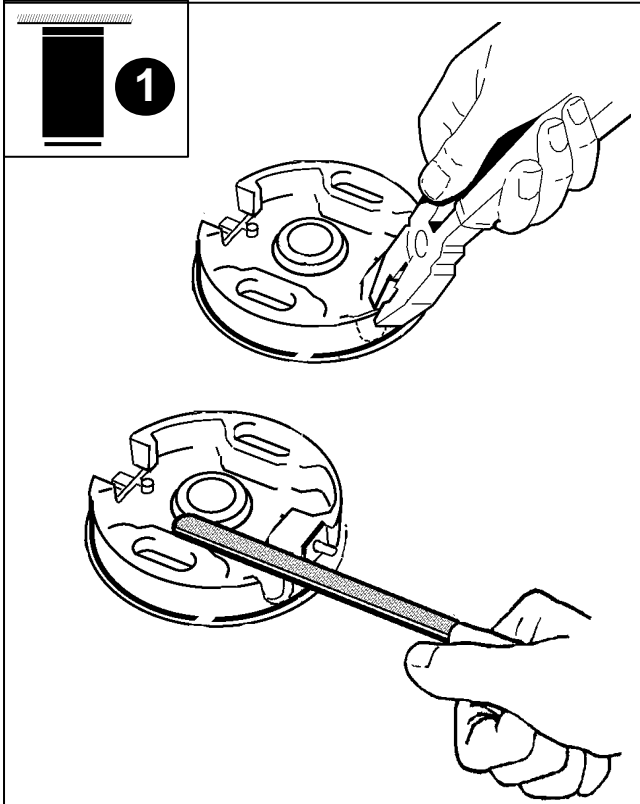
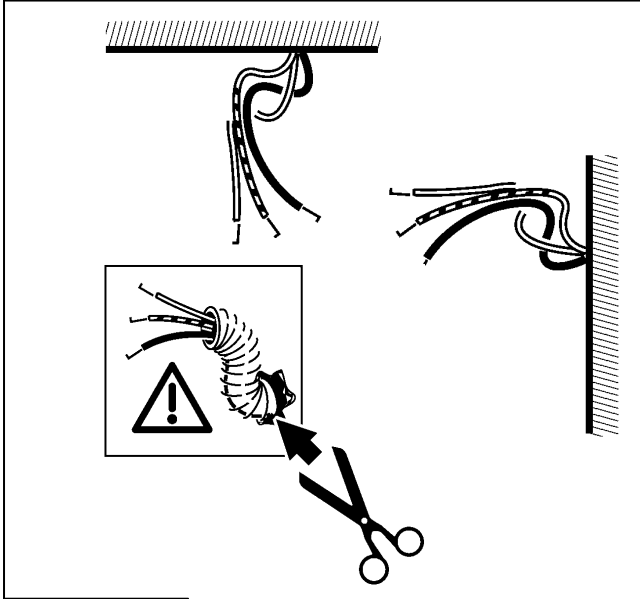
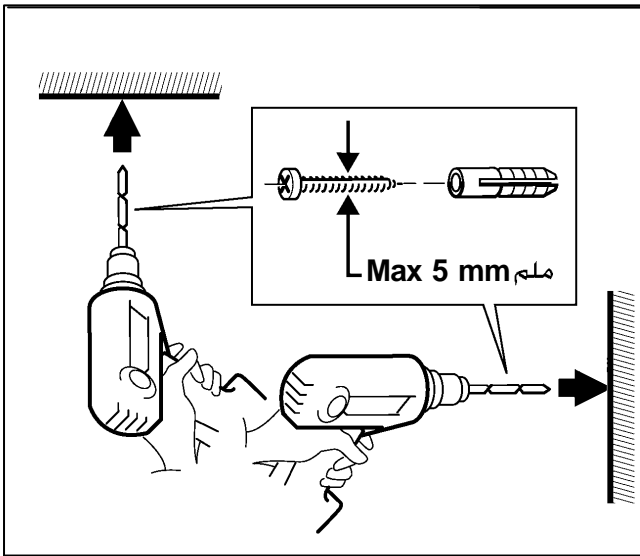

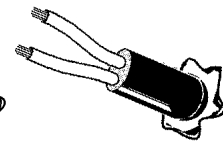
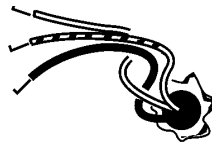
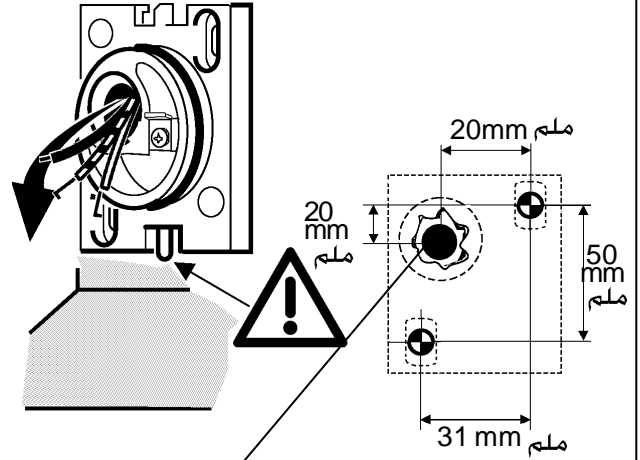
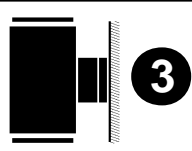
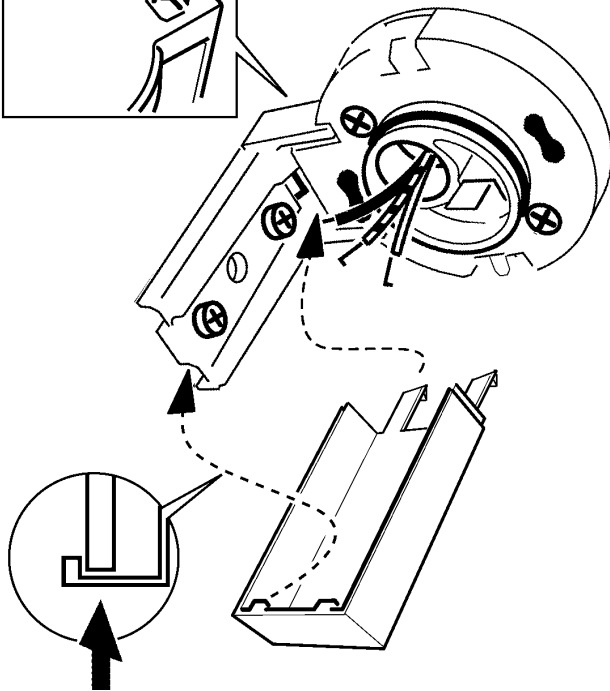
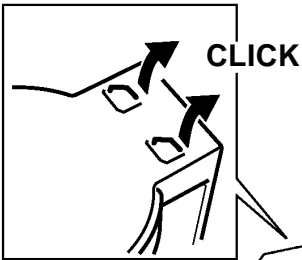
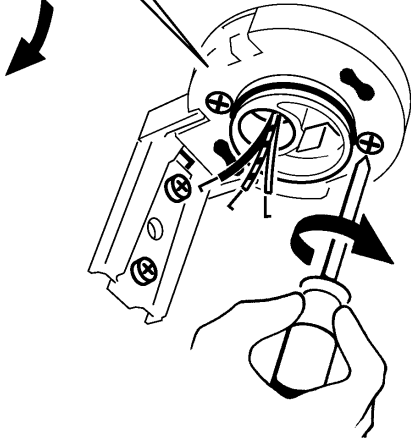
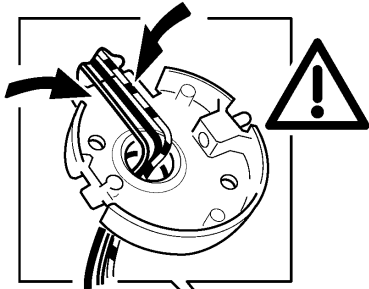

مصدر التيار
ALIMENTAZIONE
POWERSUPPLY
CEBADOR

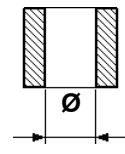
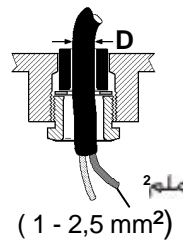
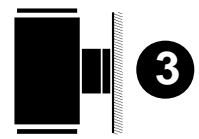
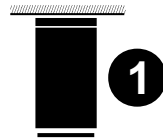

| D (mm) مم | Ø (mm) مم |
|-----------------|-----------------|
| 6,5 ÷ 9 | 8 |
| 9 ÷ 11,5 | 10,5 |

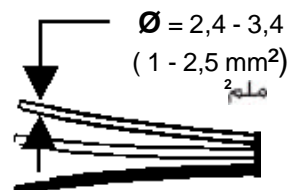
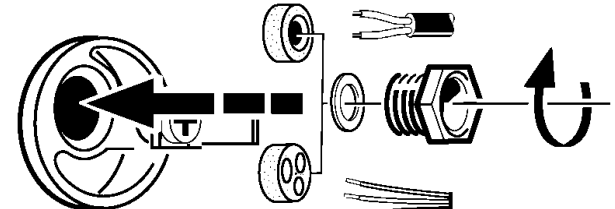

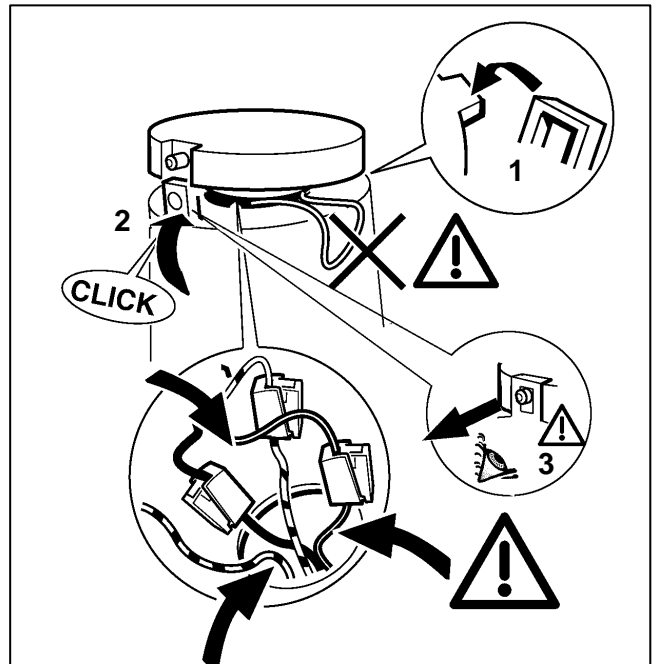
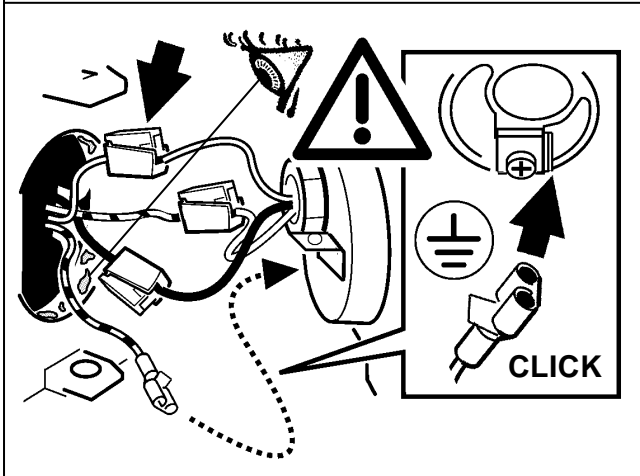
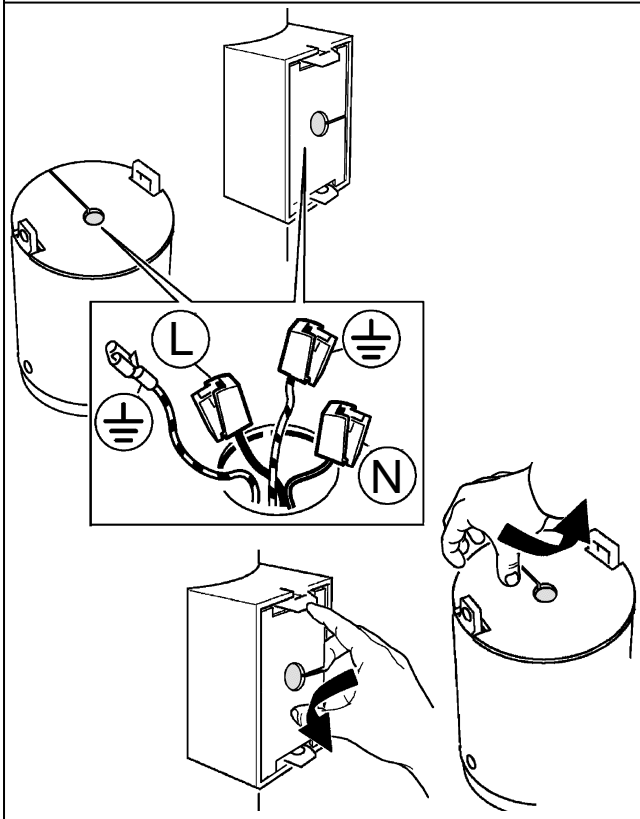
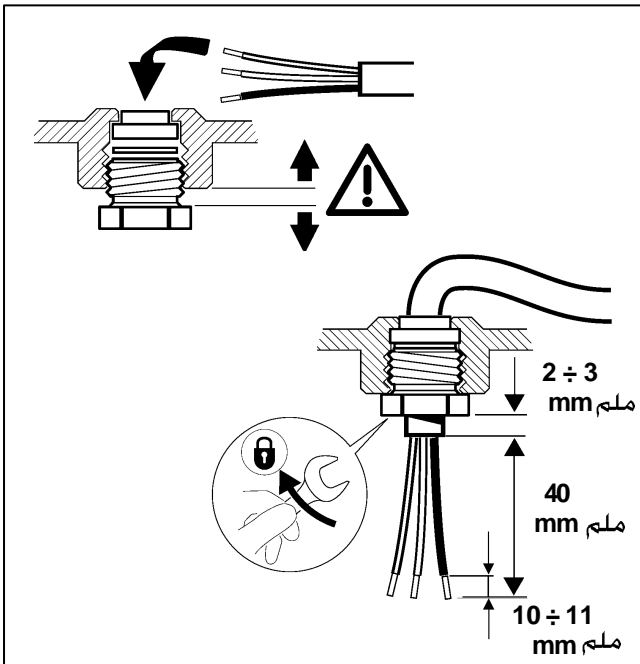

art. BZ17 - BZ18 - BZ19

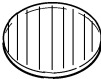
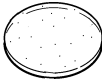
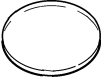
| الصنف ART |  |  |  |
|--|---|---|---|
| | art. | art. | art. |
| BA79 - BA80 BA82 - BA83 BA85 - BA86 BA88 - BA89 BA91 - BA92 BA94 - BA95 | BZ17 | BZ19 | BZ18 |
| BA81 - BA84 BA87 - BA90 BA93 - BA96 | BZ17 | BZ19 | - |

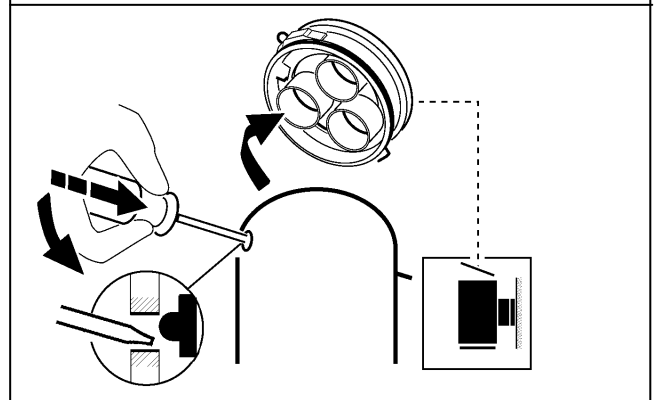
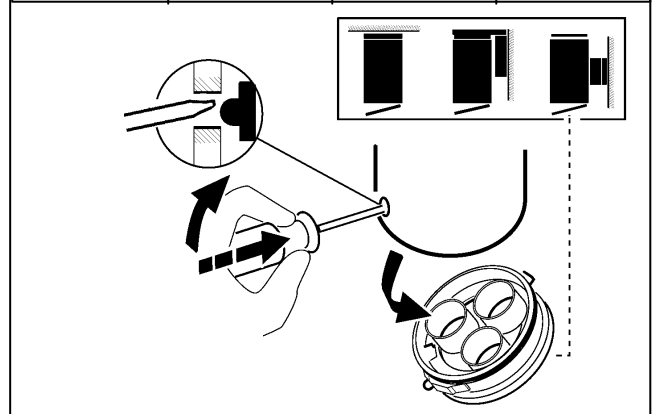

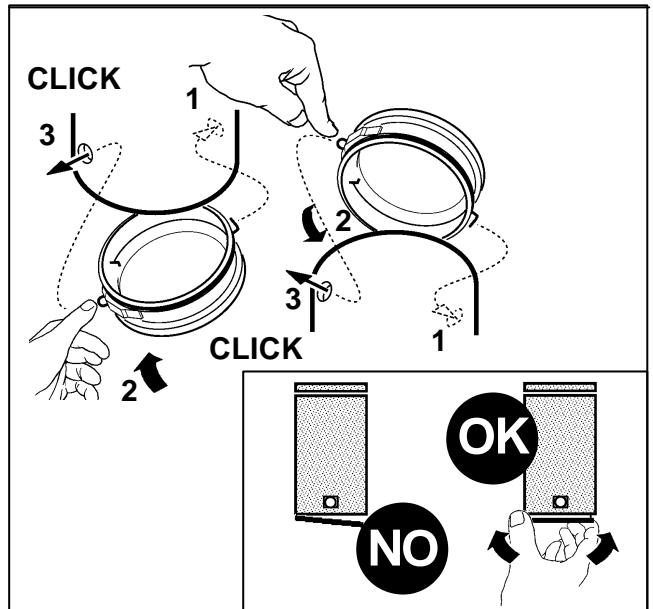
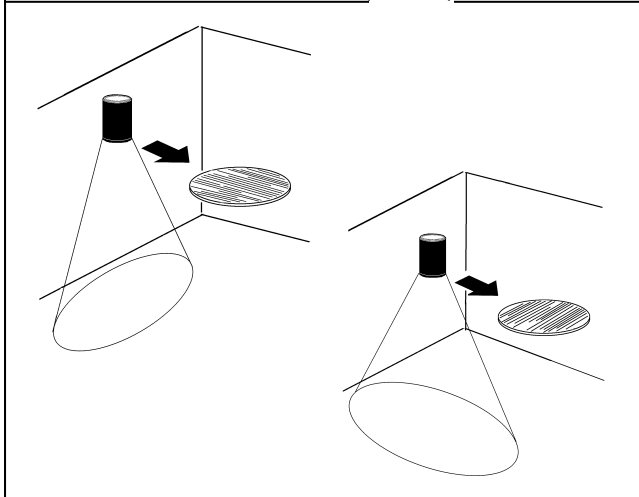
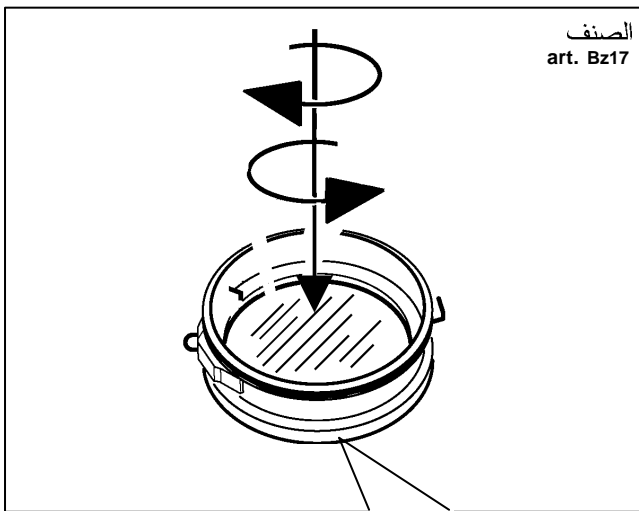
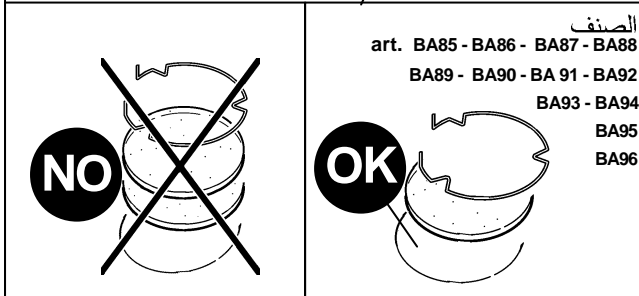
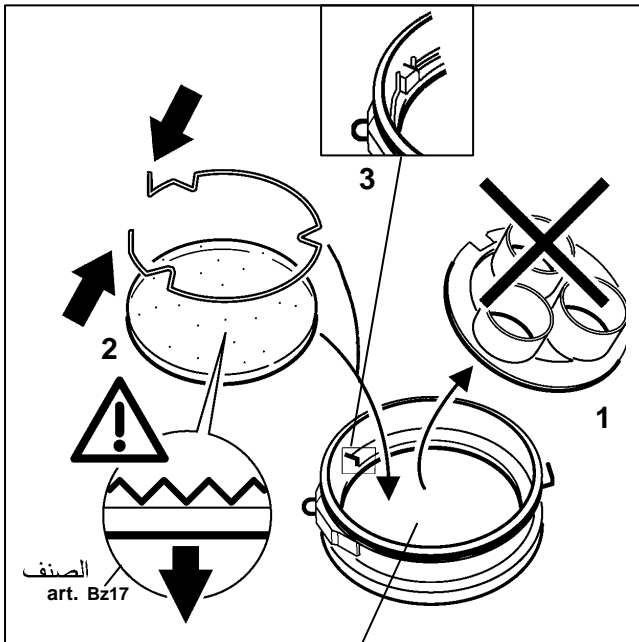

SOSTITUZIONEDELLED
REPLACINGTHELED
REEMPLAZODELLED

استبدال الضوء LED

تنبيه: لاستبدال الضوء LED اتصل بشركة iGuzzini . عر

I N.B.: Per la sostituzione del LED contattare l'azienda iGuzzini.

GB N.B.: For information on LED replacement please contact iGuzzini.

E NOTA: Para sustituir el LED llame a la empresa iGuzzini.



زجاج عادي

VETROSÓDICO-CALCÍCO
SODA-LIME GLASS
CRISTAL SÓDICO-CALCÁREO

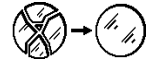

لا يمكن استعمال المنتج في حالة كسر الزجاج، وبالتالي يجب الإتصال بالمانع لاستبداله. عر

I In caso di rottura del vetro il prodotto non può essere utilizzato, contattare il costruttore per la sua sostituzione.

GB Should the glass break, the product cannot be used and you should contact the manufacturer for its replacement.

E No utilizar el producto en caso de ruptura del vidrio y contactar el fabricante para la sustitución.

1.154.544.00

IS00766/05

SOSTITUZIONE DEL LED
REPLACING THE LED
REPLACEMENT DE LA LED
AUSTAUSCHEN DER LED
VERVANGEN VAN DE LED
REEMPLAZO DEL LED
UDSKIFTNING AF LYSDIODE
BYTE AV LYSDIOD
UTSKIFTING AV DEN LYSEMITTERENDE DIODEN
ЗАМЕНА СИДа
发光二极管替换

I N.B.: Per la sostituzione del LED contattare l'azienda iGuzzini.

GB N.B.: For information on LED replacement please contact iGuzzini.

F N.B.: Pour procéder au remplacement de la LED, adressez-vous à la société iGuzzini.

D N.B.: Bezüglich des Austausches der LED kontaktieren Sie bitte die Firma iGuzzini.

NL N.B.: Voor het vervangen van de LED neemt u contact op met het bedrijf iGuzzini.

E NOTA: Para sustituir el LED llame a la empresa iGuzzini.

DK N.B.: For udskiftning af lysdioden, skal man kontakte iGuzzini.

N N.B.: For informasjon om skifte av LED, vennligst ta kontakt med iGuzzini.

S OBS! För byte av lysdioden, kontakta företaget iGuzzini.

RUS ПРИМЕЧАНИЕ:Для замены СИДов обращайтесь в компанию iGuzzini.

CN 注意: 如需LED更换的信息, 请联系iGuzzini.

I Gruppo di rischio 1, secondo norma **EN 62471: 2008**
GB Risk Group: 1, in compliance with Standard **EN 62471: 2008**
FR Groupe de risque 1, suivant la norme **EN 62471 : 2008**
DE Risikogruppe 1, gemäß Vorschrift **EN 62471: 2008**
NL Risicogroep 1, volgens de norm **EN 62471: 2008**
E Grupo de riesgo 1, según norma **EN 62471: 2008**
DK Faregruppe 1 i henhold til standarden **EN 62471: 2008**
N Risikogruppe 1, i henhold til forskriften **EN 62471: 2008**
S Riskgrupp 1, enligt standard **EN 62471: 2008**
RUS GROUP РИСК 1 В СООТВЕТСТВИИ СО **EN 62471: 2008**

CN 风险组:1
灯具和灯具系统的光生物学安全性符合标准 **EN 62471: 2008**

iGuzzini

1.154.544.00

IS00766/05

SOSTITUZIONE DEL LED
REPLACING THE LED
REPLACEMENT DE LA LED
AUSTAUSCHEN DER LED
VERVANGEN VAN DE LED
REEMPLAZO DEL LED
UDSKIFTNING AF LYSDIODE
BYTE AV LYSDIOD
UTSKIFTING AV DEN LYSEMITTERENDE DIODEN
ЗАМЕНА СИДа
发光二极管替换

I N.B.: Per la sostituzione del LED contattare l'azienda iGuzzini.

GB N.B.: For information on LED replacement please contact iGuzzini.

F N.B.: Pour procéder au remplacement de la LED, adressez-vous à la société iGuzzini.

D N.B.: Bezüglich des Austausches der LED kontaktieren Sie bitte die Firma iGuzzini.

NL N.B.: Voor het vervangen van de LED neemt u contact op met het bedrijf iGuzzini.

E NOTA: Para sustituir el LED llame a la empresa iGuzzini.

DK N.B.: For udskiftning af lysdioden, skal man kontakte iGuzzini.

N N.B.: For informasjon om skifte av LED, vennligst ta kontakt med iGuzzini.

S OBS! För byte av lysdioden, kontakta företaget iGuzzini.

RUS ПРИМЕЧАНИЕ:Для замены СИДов обращайтесь в компанию iGuzzini.

CN 注意: 如需LED更换的信息, 请联系iGuzzini.

I Gruppo di rischio 1, secondo norma **EN 62471: 2008**
GB Risk Group: 1, in compliance with Standard **EN 62471: 2008**
FR Groupe de risque 1, suivant la norme **EN 62471 : 2008**
DE Risikogruppe 1, gemäß Vorschrift **EN 62471: 2008**
NL Risicogroep 1, volgens de norm **EN 62471: 2008**
E Grupo de riesgo 1, según norma **EN 62471: 2008**
DK Faregruppe 1 i henhold til standarden **EN 62471: 2008**
N Risikogruppe 1, i henhold til forskriften **EN 62471: 2008**
S Riskgrupp 1, enligt standard **EN 62471: 2008**
RUS GROUP РИСК 1 В СООТВЕТСТВИИ СО **EN 62471: 2008**

CN 风险组:1
灯具和灯具系统的光生物学安全性符合标准 **EN 62471: 2008**

iGuzzini

1.154.544.00

IS00766/05

SOSTITUZIONE DEL LED
REPLACING THE LED
REPLACEMENT DE LA LED
AUSTAUSCHEN DER LED
VERVANGEN VAN DE LED
REEMPLAZO DEL LED
UDSKIFTNING AF LYSDIODE
BYTE AV LYSDIOD
UTSKIFTING AV DEN LYSEMITTERENDE DIODEN
ЗАМЕНА СИДа
发光二极管替换

I N.B.: Per la sostituzione del LED contattare l'azienda iGuzzini.

GB N.B.: For information on LED replacement please contact iGuzzini.

F N.B.: Pour procéder au remplacement de la LED, adressez-vous à la société iGuzzini.

D N.B.: Bezüglich des Austausches der LED kontaktieren Sie bitte die Firma iGuzzini.

NL N.B.: Voor het vervangen van de LED neemt u contact op met het bedrijf iGuzzini.

E NOTA: Para sustituir el LED llame a la empresa iGuzzini.

DK N.B.: For udskiftning af lysdioden, skal man kontakte iGuzzini.

N N.B.: For informasjon om skifte av LED, vennligst ta kontakt med iGuzzini.

S OBS! För byte av lysdioden, kontakta företaget iGuzzini.

RUS ПРИМЕЧАНИЕ:Для замены СИДов обращайтесь в компанию iGuzzini.

CN 注意: 如需LED更换的信息, 请联系iGuzzini.

I Gruppo di rischio 1, secondo norma **EN 62471: 2008**
GB Risk Group: 1, in compliance with Standard **EN 62471: 2008**
FR Groupe de risque 1, suivant la norme **EN 62471 : 2008**
DE Risikogruppe 1, gemäß Vorschrift **EN 62471: 2008**
NL Risicogroep 1, volgens de norm **EN 62471: 2008**
E Grupo de riesgo 1, según norma **EN 62471: 2008**
DK Faregruppe 1 i henhold til standarden **EN 62471: 2008**
N Risikogruppe 1, i henhold til forskriften **EN 62471: 2008**
S Riskgrupp 1, enligt standard **EN 62471: 2008**
RUS GROUP РИСК 1 В СООТВЕТСТВИИ СО **EN 62471: 2008**

CN 风险组:1
灯具和灯具系统的光生物学安全性符合标准 **EN 62471: 2008**

iGuzzini

I PERIODO GIORNALIERO DI ACCENSIONE AMMESSO
GB ALLOWED DAILY OPERATION PERIOD
F DURÉE QUOTIDIENNE D'ALLUMAGE ADMISSIBLE
D ERLAUBTE TÄGLICHE EINSCHALTDAUER
NL DAGELIJKSE ONTSTEKINGSPERIODE TOEGESTAAN
E PERIODO DIARIO DE ENCENDIDO PERMITIDO
DK TILLADT TIDSRUM FOR DAGLIG TÆNDING
N TILLÄTT TENNINGSTID PR. DAG
S TILLÄTEN DAGLIG PERIOD SOM PRODUKTEN KAN VARA TÄND
RUS ЕЖЕДНЕВНАЯ ДОПУСТИМАЯ ПРОДОЛЖИТЕЛЬНОСТЬ РАБОТЫ
CN 允许的日常运营周期

iGuzzini

1.154.627.01
 IS09175/01

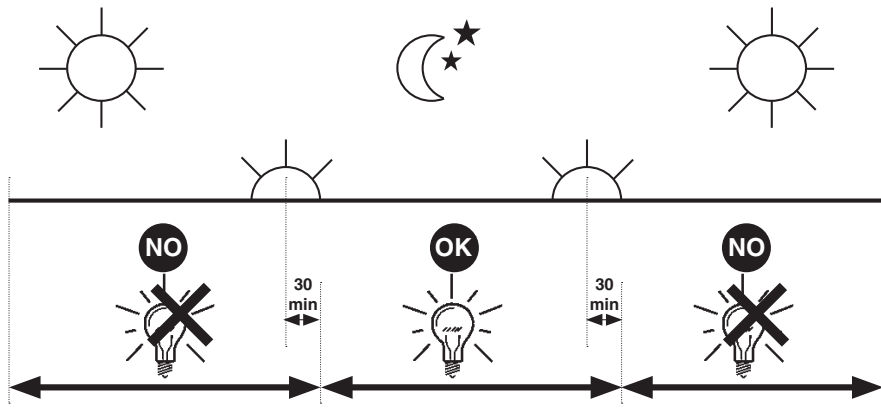

I PERIODO GIORNALIERO DI ACCENSIONE AMMESSO
GB ALLOWED DAILY OPERATION PERIOD
F DURÉE QUOTIDIENNE D'ALLUMAGE ADMISSIBLE
D ERLAUBTE TÄGLICHE EINSCHALTDAUER
NL DAGELIJKSE ONTSTEKINGSPERIODE TOEGESTAAN
E PERIODO DIARIO DE ENCENDIDO PERMITIDO
DK TILLADT TIDSRUM FOR DAGLIG TÆNDING
N TILLÄTT TENNINGSTID PR. DAG
S TILLÄTEN DAGLIG PERIOD SOM PRODUKTEN KAN VARA TÄND
RUS ЕЖЕДНЕВНАЯ ДОПУСТИМАЯ ПРОДОЛЖИТЕЛЬНОСТЬ РАБОТЫ
CN 允许的日常运营周期

iGuzzini

1.154.627.01
 IS09175/01

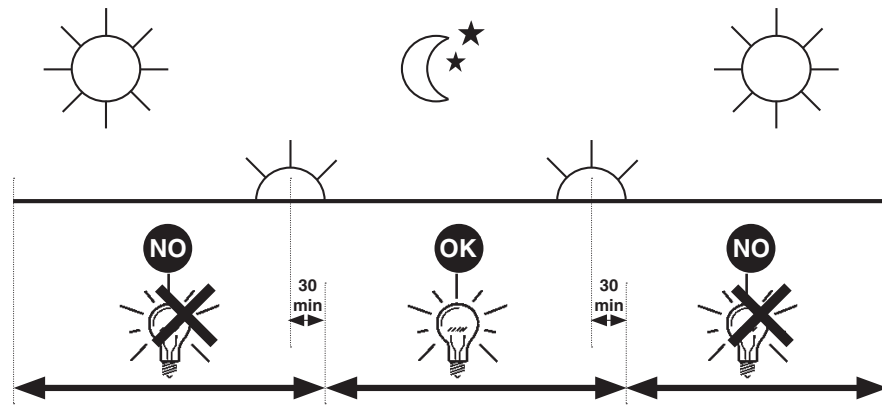

I PERIODO GIORNALIERO DI ACCENSIONE AMMESSO
GB ALLOWED DAILY OPERATION PERIOD
F DURÉE QUOTIDIENNE D'ALLUMAGE ADMISSIBLE
D ERLAUBTE TÄGLICHE EINSCHALTDAUER
NL DAGELIJKSE ONTSTEKINGSPERIODE TOEGESTAAN
E PERIODO DIARIO DE ENCENDIDO PERMITIDO
DK TILLADT TIDSRUM FOR DAGLIG TÆNDING
N TILLÄTT TENNINGSTID PR. DAG
S TILLÄTEN DAGLIG PERIOD SOM PRODUKTEN KAN VARA TÄND
RUS ЕЖЕДНЕВНАЯ ДОПУСТИМАЯ ПРОДОЛЖИТЕЛЬНОСТЬ РАБОТЫ
CN 允许的日常运营周期

iGuzzini

1.154.627.01
 IS09175/01

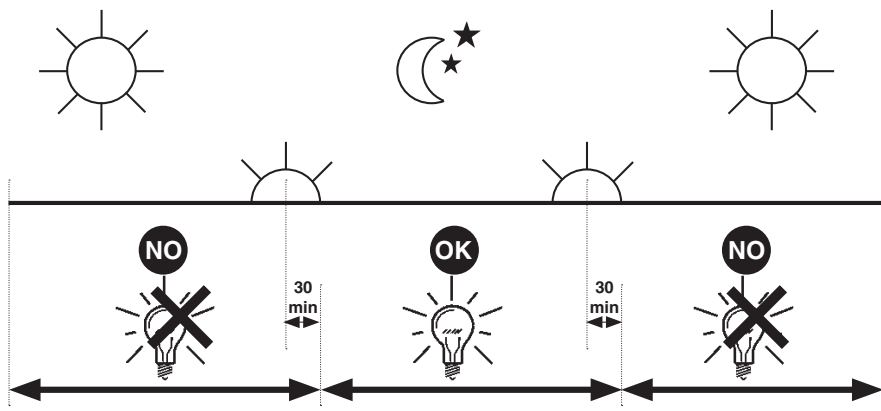

I PERIODO GIORNALIERO DI ACCENSIONE AMMESSO
GB ALLOWED DAILY OPERATION PERIOD
F DURÉE QUOTIDIENNE D'ALLUMAGE ADMISSIBLE
D ERLAUBTE TÄGLICHE EINSCHALTDAUER
NL DAGELIJKSE ONTSTEKINGSPERIODE TOEGESTAAN
E PERIODO DIARIO DE ENCENDIDO PERMITIDO
DK TILLADT TIDSRUM FOR DAGLIG TÆNDING
N TILLÄTT TENNINGSTID PR. DAG
S TILLÄTEN DAGLIG PERIOD SOM PRODUKTEN KAN VARA TÄND
RUS ЕЖЕДНЕВНАЯ ДОПУСТИМАЯ ПРОДОЛЖИТЕЛЬНОСТЬ РАБОТЫ
CN 允许的日常运营周期

iGuzzini

1.154.627.01
 IS09175/01

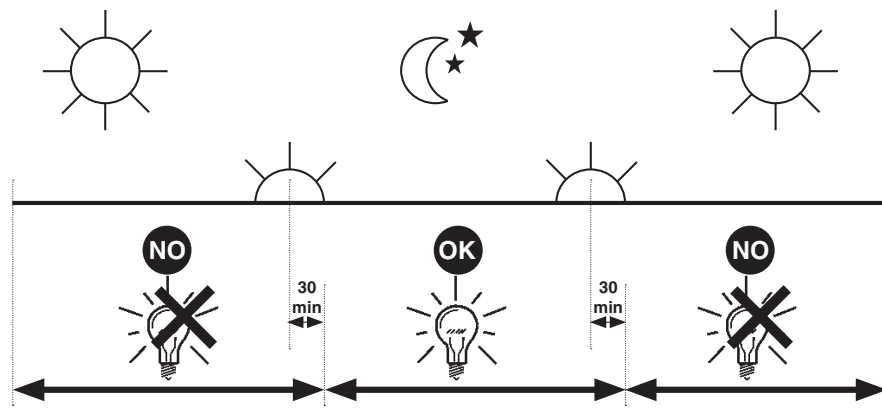

2.509.216.00
IS05718/01

استبدال الضوء LED
SOSTITUZIONE DEL LED
REPLACING THE LED
REEMPLAZO DEL LED

تنبیه: لاستبدال الضوء LED اتصل بشركة iGuzzini .

I N.B.: Per la sostituzione del LED contattare l'azienda iGuzzini.

GB N.B.: For information on LED replacement please contact iGuzzini.

E NOTA: Para sustituir el LED llame a la empresa iGuzzini.

فئة الخطر 1 . حسب مقاييس EN 62471: 2008 .

I Gruppo di rischio 1, secondo norma EN 62471: 2008

GB Risk Group: 1, in compliance with Standard EN 62471: 2008

E Grupo de riesgo 1, según norma EN 62471: 2008

iGuzzini

2.509.216.00
IS05718/01

استبدال الضوء LED
SOSTITUZIONE DEL LED
REPLACING THE LED
REEMPLAZO DEL LED

تنبیه: لاستبدال الضوء LED اتصل بشركة iGuzzini .

I N.B.: Per la sostituzione del LED contattare l'azienda iGuzzini.

GB N.B.: For information on LED replacement please contact iGuzzini.

E NOTA: Para sustituir el LED llame a la empresa iGuzzini.

فئة الخطر 1 . حسب مقاييس EN 62471: 2008 .

I Gruppo di rischio 1, secondo norma EN 62471: 2008

GB Risk Group: 1, in compliance with Standard EN 62471: 2008

E Grupo de riesgo 1, según norma EN 62471: 2008

iGuzzini

2.509.216.00
IS05718/01

استبدال الضوء LED
SOSTITUZIONE DEL LED
REPLACING THE LED
REEMPLAZO DEL LED

تنبیه: لاستبدال الضوء LED اتصل بشركة iGuzzini .

I N.B.: Per la sostituzione del LED contattare l'azienda iGuzzini.

GB N.B.: For information on LED replacement please contact iGuzzini.

E NOTA: Para sustituir el LED llame a la empresa iGuzzini.

فئة الخطر 1 . حسب مقاييس EN 62471: 2008 .

I Gruppo di rischio 1, secondo norma EN 62471: 2008

GB Risk Group: 1, in compliance with Standard EN 62471: 2008

E Grupo de riesgo 1, según norma EN 62471: 2008

iGuzzini

2.509.216.00
IS05718/01

استبدال الضوء LED
SOSTITUZIONE DEL LED
REPLACING THE LED
REEMPLAZO DEL LED

تنبیه: لاستبدال الضوء LED اتصل بشركة iGuzzini .

I N.B.: Per la sostituzione del LED contattare l'azienda iGuzzini.

GB N.B.: For information on LED replacement please contact iGuzzini.

E NOTA: Para sustituir el LED llame a la empresa iGuzzini.

فئة الخطر 1 . حسب مقاييس EN 62471: 2008 .

I Gruppo di rischio 1, secondo norma EN 62471: 2008

GB Risk Group: 1, in compliance with Standard EN 62471: 2008

E Grupo de riesgo 1, según norma EN 62471: 2008

iGuzzini

2.509.216.00
IS05718/01

استبدال الضوء LED
SOSTITUZIONE DEL LED
REPLACING THE LED
REEMPLAZO DEL LED

تنبیه: لاستبدال الضوء LED اتصل بشركة iGuzzini .

I N.B.: Per la sostituzione del LED contattare l'azienda iGuzzini.

GB N.B.: For information on LED replacement please contact iGuzzini.

E NOTA: Para sustituir el LED llame a la empresa iGuzzini.

فئة الخطر 1 . حسب مقاييس EN 62471: 2008 .

I Gruppo di rischio 1, secondo norma EN 62471: 2008

GB Risk Group: 1, in compliance with Standard EN 62471: 2008

E Grupo de riesgo 1, según norma EN 62471: 2008

iGuzzini

iGuzzini

2.509.386.00
ISO9176/01

الفترة الزمنية اليومية للتشغيل المسموح بها

- I PERIODO GIORNALIERO DI ACCENSIONE AMMESSO
- GB ALLOWED DAILY OPERATION PERIOD
- E PERIODO DIARIO DE ENCENDIDO PERMITIDO

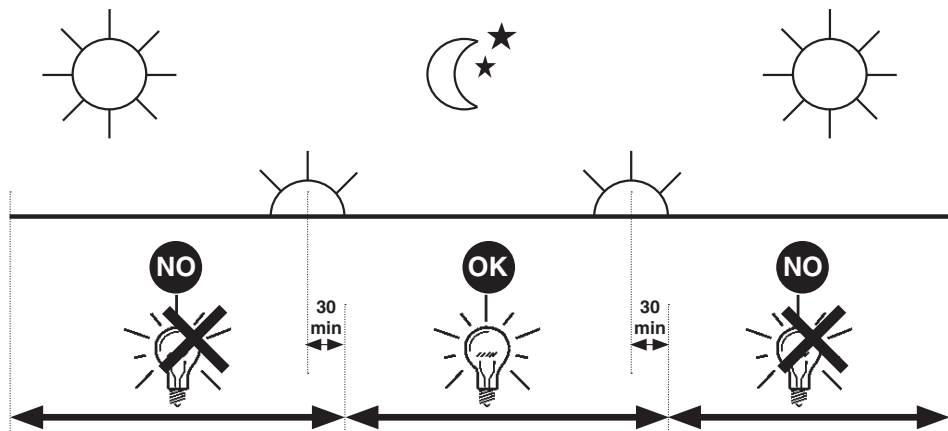

iGuzzini

2.509.386.00
ISO9176/01

الفترة الزمنية اليومية للتشغيل المسموح بها

- I PERIODO GIORNALIERO DI ACCENSIONE AMMESSO
- GB ALLOWED DAILY OPERATION PERIOD
- E PERIODO DIARIO DE ENCENDIDO PERMITIDO

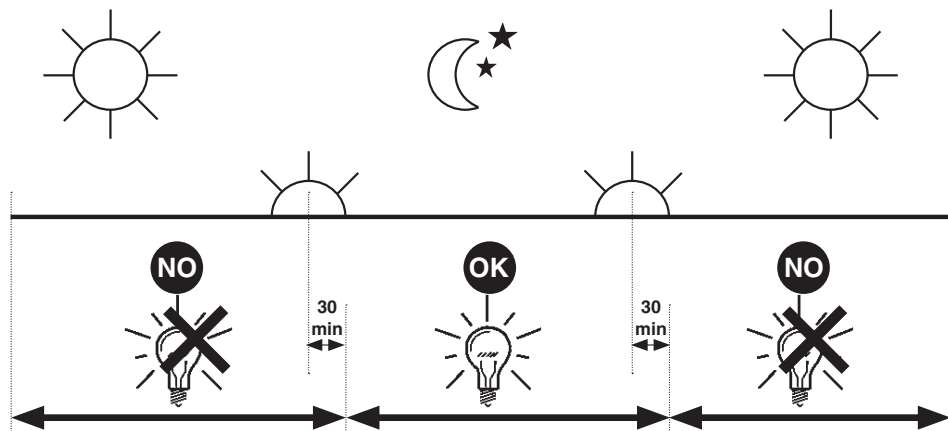

iGuzzini

2.509.386.00
ISO9176/01

الفترة الزمنية اليومية للتشغيل المسموح بها

- I PERIODO GIORNALIERO DI ACCENSIONE AMMESSO
- GB ALLOWED DAILY OPERATION PERIOD
- E PERIODO DIARIO DE ENCENDIDO PERMITIDO

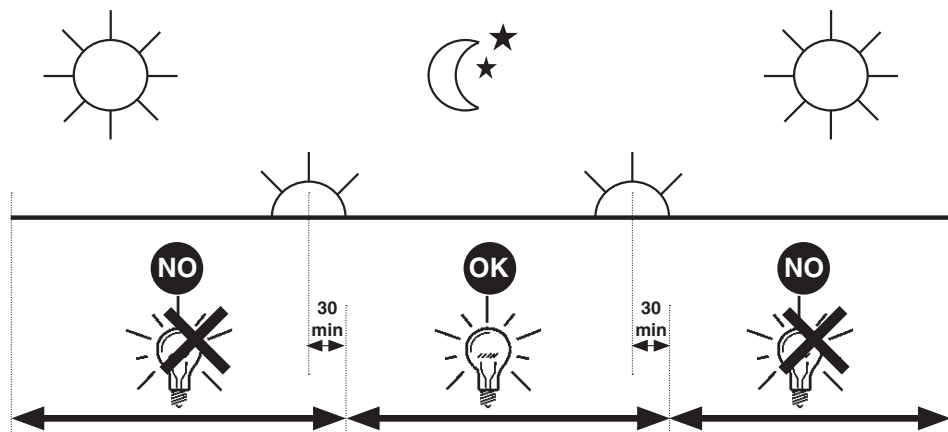

iGuzzini

2.509.386.00
ISO9176/01

الفترة الزمنية اليومية للتشغيل المسموح بها

- I PERIODO GIORNALIERO DI ACCENSIONE AMMESSO
- GB ALLOWED DAILY OPERATION PERIOD
- E PERIODO DIARIO DE ENCENDIDO PERMITIDO

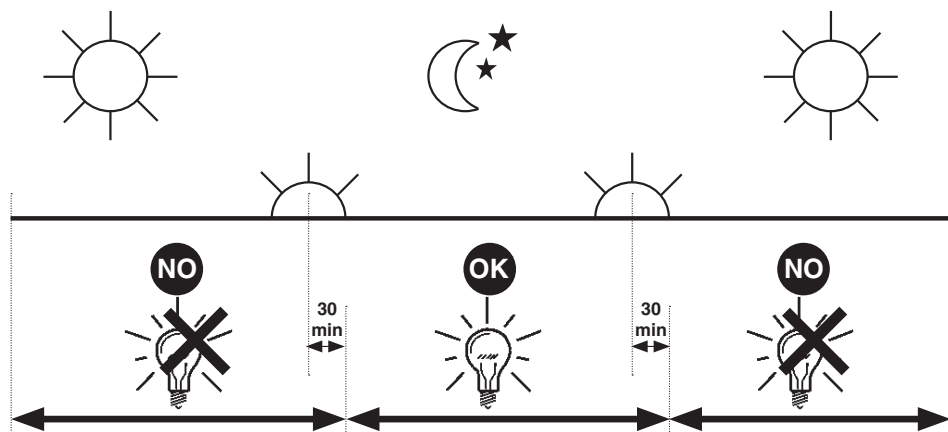

- I Istruzioni per le operazioni di servizio per l'apparecchio di illuminazione**
GB Instructions on luminaire service operations
F Instructions pour les opérations de service du luminaire
D Wartungsanleitung für die Leuchte
NL Instructies voor de onderhoudsoperaties op de verlichtingsarmatuur
E Instrucciones para las operaciones de servicio del aparato de alumbrado
DK Anvisninger i serviceindgreb på belysningsarmatur
N Anvisninger for betjening av lysapparatet
S Instruktioner för användning av belysningsanordningen
RUS Инструкции по эксплуатации осветительного прибора
CN 照明装置检修操作说明

Sostituire la lampada parzialmente esausta
 Replace the partly exhausted lamp
 Remplacer la lampe partiellement épuisée
 Die teilweise erschöpfte Lampe austauschen
 Vervang de gedeeltelijk lege lamp
 Sustituir la lámpara parzialmente agotada
 Udskift den delvist udtjente pære
 Skifte ut den delvis utbrente lyspæren
 Byt ut den delvis förbrukade lampan
 Замена частично отработанной лампочки
 更换部分老化的灯泡

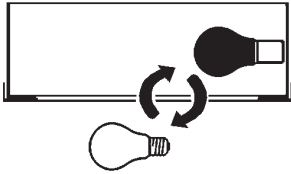

Spegnimento
 Switch it off
 Extinction
 Ausschaltung
 Uitschakeling
 Apagado
 Slukning
 Slukking
 Släckning
 Выключение
 关灯

Interrompere l'alimentazione dell'apparecchio
 Cut the power supply to the luminaire
 Couper l'alimentation du luminaire
 Stromversorgung der Leuchte unterbrechen
 Onderbreek de voeding van het apparaat
 Interrumpir la alimentación del aparato
 Afbryd armaturets strømforsyning
 Avbryte strømtilførselen til apparatet
 Koppla från anordningens strömförsörjning
 Отключить электропитание прибора
 中断装置供电

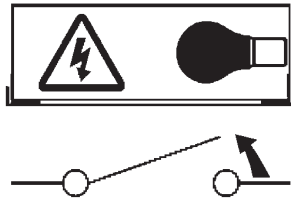

Aprire l'apparecchio
 Open the fixture
 Ouvrir le luminaire
 Das Gerät öffnen
 Open het apparaat
 Abrir el aparato
 Åbn armaturet
 Åpne apparatet
 Öppna anordningen
 Раскрыть прибор
 打开装置

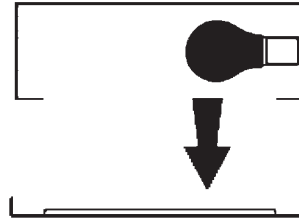

Rimuovere la lampada esausta
 Remove the exhausted lamp
 Retirer la lampe épuisée
 Die alte Lampe entnehmen
 Verwijder de lege lamp
 Quitar la lámpara agotada
 Tag den udtjente pære ud
 Fjerne den utbrente lyspæren
 Ta bort den förbrukade lampan
 Вынуть старую лампочку
 取出老化的灯泡

Portarla in un centro di riciclaggio
 Carry it to a recycling centre
 La porter dans une déchetterie pour son recyclage
 Ordnungsgemäß entsorgen
 Breng de lamp naar een recyclingcentrum
 Llevarla a un centro de reciclaje
 Aflever den på en genbrugsstation
 Lever den til en miljøstasjon
 Lämna in den till en återvinningsanläggning
 Сдать ее в пункт приема утильсырья
 将其送往回收中心

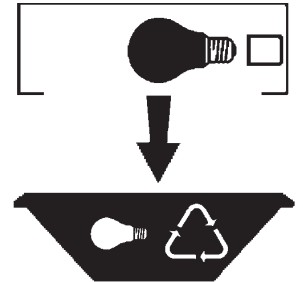

Inserire la nuova lampada
 Introduce the new lamp
 Installer la lampe neuve
 Die neue Lampe einsetzen
 Doe de nieuwe lamp op zijn plek
 Montar la nueva lámpara
 Sæt den nye pære i
 Sette i den nye pæren
 Sätt i den nya lampan
 Вставить новую лампочку
 装入新灯泡

Inserire la nuova lampada nel portalampada
 Fit the new lamp into the socket
 Installer la nouvelle lampe dans le support de lampe
 Die neue Lampe in den Sockel einsetzen
 Doe de nieuwe lamp in de lamphouder
 Montar la nueva lámpara en el portalámpara
 Sæt den nye pære i fatningen
 Sette den nye pæren inn i lampeholderen
 Sätt i den nya lampan i lamphållaren
 Вставить новую лампочку в патрон
 将新灯泡插入灯泡架中

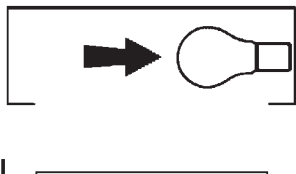

Riposizionare ottica
 Re-place the optic
 Remettre l'optique à sa place
 Die Optik wieder einsetzen
 Doe de optiek weer op zijn plaats
 Volver a montar la óptica
 Sæt den optiske enhed på plads
 Innstille linsen
 Flytta om optiken
 Отрегулировать линзы
 重新定位光头

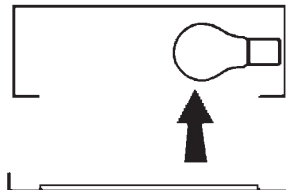

Effettuare prova di funzionamento
 Perform operative test
 Procéder à un essai de fonctionnement
 Eine Funktionsprüfung durchführen
 Controleer de correcte werking
 Hacer una prueba de funcionamiento
 Afprøv funktionen
 Prøve om den fungerer
 Utför funktionstest
 Выполнить проверку исправности работы
 执行功能测试

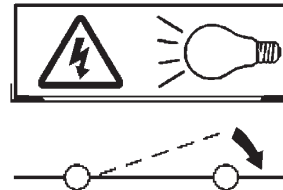

I Istruzioni per la pulizia dell'apparecchio di illuminazione
GB Instructions on luminaire cleaning operations
F Instructions pour le nettoyage du luminaire
D Anweisungen zur Reinigung der Leuchte
NL Instructies voor de reiniging van de verlichtingsarmatuur
E Instrucciones para limpiar el aparato de alumbrado
DK Anvisninger i rengøring af belysningsarmaturet
N Anvisninger for rengjøring av lysapparatet
S Instruktioner för rengöring av belysningsanordningen
RUS Инструкции по чистке осветительного прибора
CN 照明装置清洁说明

Pulire l'apparecchio
Clean the fixture
Nettoyer le luminaire
Das Gerät reinigen
Reinig het apparaat
Limpiar el aparato
Rengør armaturet
Rengjøre apparatet
Rengör anordningen
Чистка прибора
清洁装置

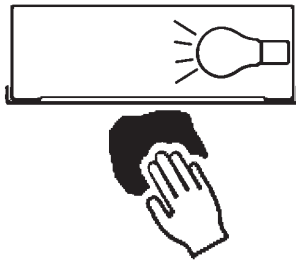

Spegnimento
Switch it off
Extinction
Ausschaltung
Uitschakeling
Apagado
Slukning
Slukking
Släckning
Выключение
关灯

Interrompere l'alimentazione dell'apparecchio
Cut the power supply to the luminaire
Couper l'alimentation du luminaire
Stromversorgung der Leuchte unterbrechen
Onderbreek de voeding van het apparaat
Interrumpir la alimentación del aparato
Afbryd armaturets strømforstyrning
Avbryt strømtilførselen til apparatet
Koppla från anordningens strömförsörjning
Отключить электропитание прибора
中断装置供电



Spolverare l'ottica esterna
Remove dust from the external optic
Dépoussiérer l'optique extérieure
Die externe Optik abstauben
Stof de externe optiek af
Quitar el polvo de la óptica exterior
Tør støvet af den udvendige optiske enhed
Fjerne støv fra den eksterne lysenheden
Damma av den yttre optiken
Вытереть пыль с внешней стороны линз
为外侧光头掸尘

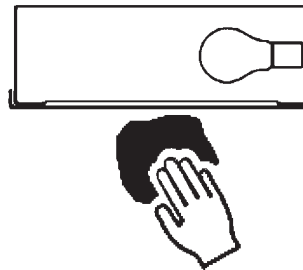

Lavare l'ottica esterna
Wash the external optic
Laver l'optique extérieure
Die externe Optik waschen
Was de externe optiek
Lavar la óptica exterior
Vask den udvendige optiske enhed
Vaske den eksterne lysenheden
Rengör den yttre optiken
Вымыть линзы с внешней стороны
清洁外光头

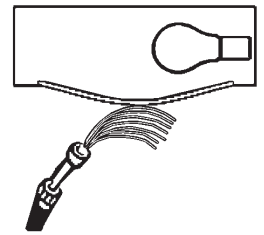

Rimuovere l'ottica
Remove the optic
Retirer l'optique
Die Optik abnehmen
Verwijder de optiek
Quitar la óptica
Tag den optiske enhed af
Fjerne lysenheden
Ta bort optiken
Снять линзы
取下光头

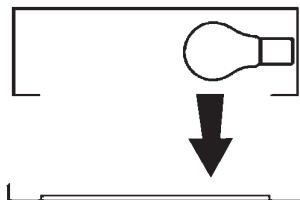

Pulire la parte interna dell'apparecchio di illuminazione
Clean the inside of the fixture
Nettoyer l'intérieur du luminaire
Die Innenseite der Leuchte reinigen
Reinig de binnenzijde van de verlichtingsarmatuur
Limpiar el interior del aparato de alumbrado
Rengør belysningsarmaturets indvendige dele
Rengjøre lysapparatet innvendig
Rengör belysningsanordningen invändigt
Протереть осветительный прибор изнутри
清洁照明装置内部



Riposizionare ottica
Re-place the optic
Remettre l'optique à sa place
Die Optik wieder einsetzen
Doe de optiek weer op zijn plaats
Volver a montar la óptica
Sæt den optiske enhed på plads
Innstille linsen
Flytta om optiken
Отрегулировать линзы
重新定位光头

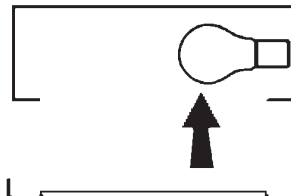

Effettuare prova di funzionamento
Perform operative test
Procéder à un essai de fonctionnement
Eine Funktionsprüfung durchführen
Controleer de correcte werking
Hacer una prueba de funcionamiento
Afprøv funktionen
Prøve om den fungerer
Utför funktionstest
Выполнить проверку исправности работы
执行功能测试

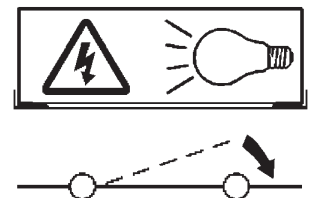

- I Istruzioni per il fine vita e lo smaltimento dei componenti
 GB Instructions on end-of-life and component disposal
 F Instructions pour la gestion des composants en fin de vie et leur mise au rebut
 D Anweisungen zur Entsorgung der Leuchtenkomponenten
 NL Instructies voor het verwijderen van de armatuur en het recyclen van de onderdelen
 E Instrucciones para el final de vida y la eliminación los componentes
 DK Anvisninger i udtjent armatur og bortskaffelse af komponenter
 N Anvisninger for endt levetid og avfallsbehandling av delene
 S Instruktioner vid bortskaffning och kassering av komponenter
 RUS Инструкции по утилизации прибора и его комплектующих по окончании его срока службы
 CN 寿命期结束与零件废弃处置说明

| | | | |
|---|--|--|--|
| <p>Spegnimento Switch it off Extinction Ausschaltung Uitschakeling Apagado Slukning Slukking Släckning Выключение 关灯</p> <p>Interrompere l'alimentazione dell'apparecchio Cut the power supply to the luminaire Couper l'alimentation du luminaire Stromversorgung der Leuchte unterbrechen Onderbreek de voeding van het apparaat Interrompirla alimentación del aparato Afbryd armaturets strømforsyning Avbryt strømtilførselen til apparatet Koppla från anordningens strömförsörjning Отключить электропитание прибора 中断装置供电</p>  | <p>Rimuovere la/e lampada/e per la dismissione Remove the lamp(s) for decommissioning Retirer la(les) lampe(s) pour sa(leur) mise au rebut Die Lampe/n ordnungsgemäß entsorgen Verwijder de lamp(en) voor het recyclen Quitar la(s) lámpara(s) para el desecho Tag pæren/pærerne ud til bortskaffelse Fjerne lampen/-e som skal kastes Ta bort lampan/-orna för bortskaffningen Вынуть лампочку/и для утилизации прибора 取出需要丢弃的灯泡</p>  | <p>Rimuovere la batteria per la dismissione Remove the battery for decommissioning Retirer la batterie pour sa mise au rebut Die Batterie ordnungsgemäß entsorgen Verwijder de batterij voor het recyclen Quitar la batería para el desecho Tag batteriet ud til bortskaffelse Fjerne batteriet som skal kastes Ta bort batteriet för bortskaffningen Вынуть батарейку для утилизации прибора 取出需要丢弃的电池</p>  | <p>Rimuovere l'apparecchio per la dismissione Remove the fixture for decommissioning Enlever le luminaire pour sa mise au rebut Das Gerät ordnungsgemäß entsorgen Verwijder het apparaat voor het recyclen Quitar el aparato para el desecho Tag armaturet ud til bortskaffelse Fjerne apparatet som skal kastes Ta bort anordningen för bortskaffningen Снять прибор для утилизации 取出需要丢弃的装置</p>  |
|---|--|--|--|

| | | | |
|--|--|--|--|
| <p>Inviare i materiali ad un centro di raccolta RAEE Send the materials to a WEEE collection centre Envoyer les matériaux dans une déchetterie DEEE Die Materialien in einem WEEE-Zentrum entsorgen Zend de materialen naar een recyclingscentrum voor de AEEA Enviar los materiales a un centro de recogida RAEE Afløver materialerne på et indsamlingscenter for elektronisk udstyr Sende materialene til en miljøstasjon for resirkulering av EE-avfall Skicka materialet till en RAEE uppsamlingscentral Сдать материалы в пункт приема утильсырья 将材料送往电气和电子垃圾回收中心</p>  | | | |
|--|--|--|--|