

LEDPLUS

I ATTENZIONE:

LA SICUREZZA DELL'APPARECCHIO È GARANTITA SOLO CON L'USO APPROPRIATO DELLE SEGUENTI ISTRUZIONI; PERTANTO È NECESSARIO CONSERVARLE.

GB WARNING:

THE SAFETY OF THIS FIXTURE IS GUARANTEED ONLY IF YOU COMPLY WITH THESE INSTRUCTIONS; REMEMBER TO CONSERVE IN A SAFE PLACE.

F ATTENTION:

LA SECURITE DE L'APPAREIL N'EST GARANTIE QU'EN CAS D'UTILISATION CORRECTE DES INSTRUCTIONS SUIVANTES; IL FAUT PAR CONSEQUENT LES CONSERVER.

D ACHTUNG:

DIE SICHERHEIT DES GERÄTES WIRD NUR DURCH SACHGEMÄSSE BEFOLGUNG NACHSTEHENDER ANWEISUNGEN GEWÄHRLEISTET; IHRE AUFBEWAHRUNG IST DESHALB SEHR WICHTIG.

NL OPGELET:

DE VEILIGHEID VAN DI ATOESTEL IS SLECHTS DAN GEGARANDEERD ALS INDIEN DE VOLGENDE INSTRUCITIES STRIKT WORDEN TOEGEPAST: DAAROM MOET MEN ZE OOK BEWAREN.

E ATENCION:

LA SEGURIDAD DEL APARATO SE GARANTIZA SOLO CUMPLIENDO CUIDADOSAMENTE LAS SIGUIENTES INSTRUCCIONES; POR ELLO, ES NECESARIO CONSERVARLAS.

DK BEMÆRK:

SIKKERHEDEN VED BRUG AF ARMATURET KAN KUN GARANTERES, HVIS DISSE ANVISNINGER FØLGES; SØRG DERFOR FOR AT GEMME DEM.

N ADVARSEL:

SIKKERHETEN TIL DETTE APPARATET GARANTERES KUN HVIS DU OVERHOLDER DISSE INSTRUKSJONENE; HUSK Å OPPBEVARE DEM PÅ ET TRYGT STED.

S OBSERVERA!

UTRUSTNINGENS SÄKERHET KAN ENDAST GARANTERAS OM DESSA ANVISNINGAR RESPEKTERAS I DETALJ. SPARA DÄRFÖR DESSA ANVISNINGAR FÖR FRAMTIDA KONSULTATION.

RUS

ВНИМАНИЕ: МЫ ГАРАНТИРУЕМ БЕЗОПАСНУЮ ЭКСПЛУАТАЦИЮ ИЗДЕЛИЯ ТОЛЬКО ПРИ СОБЛЮДЕНИИ СЛЕДУЮЩИХ ИНСТРУКЦИЙ; С ЭТОЙ ЦЕЛЬЮ НЕОБХОДИМО СОХРАНИТЬ ДАННУЮ БРОШЮРУ.

CN 警告

为确保该装置安全，请遵守操作指示，并于安全场所放置。

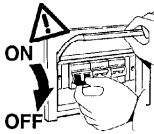

I N.B.: L'apparecchio non deve, in alcuna circostanza, essere coperto con materiale isolante o similare.

GB N.B.: The fixture must not be covered, under any circumstances, by insulating materials or the like.

F N.B.: L'appareil ne doit, en aucun cas, être couvert par un matériau isolant ou autre.

D N.B.: Das Gerät darf auf keinen Fall mit Isoliermaterial oder ähnlichem bedeckt werden.

NL N.B.: Het apparaat mag in geen geval bedekt worden met isoleringsmateriaal of dergelijke.

E NOTA: El aparato no debe ser protegido con material aislante o parecido, por ninguna causa.

DK N.B.: Armaturet må under ingen omstændigheder tildækkes med isolerende materiale eller lignende materiale.

N N.B.: Armaturen må ikke under noen omstendigheter tildekkes med isolerende materialer eller lignende.

S OBS! Utrustningen får inte under några omständigheter täckas över med isolerande material eller liknande.

RUS ПРИМЕЧАНИЕ: Категорически запрещается покрывать прибор изоляционным или подобным материалом.

CN 不管什么情况下灯具都不能被隔热衬垫或类似材料盖住



I Per la disposizione dei tubi corrugati e/o dei cavi elettrici, fare riferimento al progetto dell'impianto.

GB See the system project for the arrangement of the corrugated pipes and/or electric cables.

F Pour la disposition des conduits annelés et/ou des câbles électriques, veuillez vous reporter au projet de l'installation.

D Zur Verlegung der flexiblen Leerrohre und/oder der Elektrokabel verweisen wir auf das Anlageprojekt.

NL Het rangschikken van de gegolfde buizen en/of de elektrische kabels moet u uitvoeren op basis van de gegevens die u in het ontwerp van het systeem terugvindt.

E Para la ubicación de los tubos corrugados y/o de los cables eléctricos, hágase referencia al proyecto de la instalación.

DK Se anlægsudformningen for placering af bølgerør og/eller elektriske ledninger.

N Se systemprosjektet for ordningen av korrugerte rør og/eller elektriske kabler.

S För dragningen av korrugerade rör och/eller elkablar hänvisas till systemets projekt.

RUS Расположение гофрированных труб и/или электропроводки смотрите в проекте системы.

CN 针对波纹管和/或电缆的排列，参见系统计划。

N.B.: DURANTE L'INSTALLAZIONE DEL SISTEMA "LED PLUS" RISPETTARE SCRUPOLOSAMENTE LE NORME IMPIANTISTICHE NAZIONALI VIGENTI.

N.B.: WHEN INSTALLING THE "LED PLUS" SYSTEM, MAKE SURE ALL CURRENT NATIONAL REGULATIONS RELATING TO INSTALLATION ARE OBSERVED.

N.B.: LORS DE L'INSTALLATION DU SYSTÈME "LED PLUS" VEUILLEZ RESPECTER RIGOREUSEMENT LES NORMES EN VIGUEUR EN LA MATIÈRE DANS LE PAYS.

N.B.: BEACHTEN SIE BEI DER INSTALLATION DES SYSTEMS "LED PLUS" UNBEDINGT DIE IM LAND GELTENDEN ANLAGETECHNISCHEN VORSCHRIFTEN.

N.B.: BIJ HET INSTALLEREN VAN HET "LED PLUS" SYSTEEM MOET U DE GELDENDE NATIONALE INSTALLATIENORMEN STRIKT NALEVEN.

NOTA: DURANTE LA INSTALACIÓN DEL SISTEMA "LED PLUS" RESPETAR ESCRUPULOSAMENTE LAS NORMAS NACIONALES DE INSTALACION EN VIGOR.

N.B.: UNDER INSTALLATION AF "LED PLUS" SYSTEMET SKAL MAN NØJE OVERHOLDE DE GÆLDENDE REGLER FOR DISSE ANLÆG.

N.B.: UNDER INSTALLASJON AV SYSTEMET "LED PLUS" MÅ DE NASJONALE ANLEGGSFORSKRIFTENE OVERHOLDES NØYE.

OBS! UNDER INSTALLATIONEN AV SYSTEMET "LED PLUS" SKA GÄLLANDE NATIONELLA INSTALLATIONSFÖRESKRIFTER RESPEKTERAS I DETALJ.

ПРИМЕЧАНИЕ: В ПРОЦЕССЕ МОНТАЖА СИСТЕМЫ "LED PLUS" СТРОГО СОБЛЮДАЙТЕ НАЦИОНАЛЬНЫЕ ДЕЙСТВУЮЩИЕ НОРМАТИВЫ ПО ЭЛЕКТРОПРОВОДКЕ.

注意：安装"LED PLUS"系统时请务必遵守系统标准。

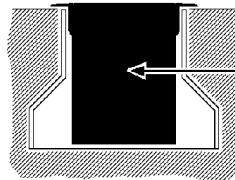

IP68 1m

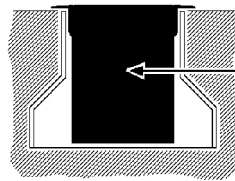

IP67

art. B318 - B319 - B320
B321 - B322 - B336
B337 - B338 - B339
B340 - BB45 - BB46
BB49 - BB50



10000/5000N



40°C

I Gli apparecchi sono stati progettati e collaudati per reggere un carico statico fino a 10000 N; la temperatura massima rilevata sul vetro è di 40°C. L'installazione è ammessa in zone pedonali, piste ciclabili o piscine.

GB The fittings were designed and tested to withstand a static load up to 10000 N. The maximum temperature measured on the glass is 40°C. The fittings can be installed on pedestrian areas, cycle lanes or swimming pools.

F Les appareils ont été spécialement conçus et testés pour supporter une charge statique pouvant atteindre 10000 N; la température maximale mesurée sur le verre est de 40°C. L'installation est autorisée dans les zones piétonnes, les pistes cyclables et les abords des piscines.

D Bei der Entwicklung und Prüfung der Leuchten wurde sichergestellt, dass sie einer statischen Belastung von bis zu 10000 N standhalten; die am Glas erfasste maximale Temperatur beträgt 40°C. Die Leuchten eignen sich zur Installation auf Gehwegen, Fahrradwegen oder Swimmingpools.

NL De apparaten zijn ontworpen en goedgekeurd om een statisch gewicht tot 10000 N te kunnen dragen; de maximumtemperatuur die op het glas is gemeten is 40°C. De installatie is toegestaan in voetgangerszones, fietspaden en zwembaden.

E Los aparatos han sido diseñados y ensayados para resistir una carga estática de 10000 N; la temperatura máxima medida en el cristal es de 40°C. La instalación está permitida en zonas peatonales, pistas de bicicletas o piscinas.

DK Armaturerne er udviklet og afprøvet til en statisk belastning på op til 10000 N. Maks. temperatur på glasset er 40°C og de er tilladt til installationer på fortove, på cykelstier eller swimmingpoolområder.

N Armaturene ble designet og testet for å motstå en statisk belastning på inntil 10000 N. Maksimal temperatur målt på glasset er 40°C. Armaturene kan installeres i gangområder, sykkelstier eller svømmebassenger.

S Utrustningen är konstruerad och testad för att tåla en statisk belastning på upp till 10000 N. Max. temperatur som har uppmätts på glasset är 40°C. Utrustningen kan installeras i områden med gågator eller cykelvägar.

RUS

Устройства были разработаны и протестированы для работы при статической нагрузке до 10000 N; максимальная температура, измеренная на поверхности стекла, 40 °С. Используются для освещения пешеходных зон, велосипедных дорожек или бассейнов.

CN

此设备经设计和测试后能经受一个为10000 N的静载荷。玻璃上的最大测量温度为40°C。此设备可以安装在步行区域，自行车车道或者是游泳池

I N.B. Si consiglia di effettuare le operazioni d'installazione o di manutenzione all'interno del vano ottico, in ambienti interni o quanto meno in assenza di umidità o pioggia.

GB N.B.: Installation and maintenance operations must be carried out inside the optical assembly, indoor and in a place with no humidity or rain.

F N.B.: Pour effectuer les opérations d'installation ou d'entretien des composants intérieurs du bloc optique, il est conseillé de se rendre dans un espace clos, ou tout du moins à l'abri de l'humidité ou de la pluie.

D Hinweis: Es empfiehlt sich, alle Installations- oder Wartungseingriffe am Leuchtgehäuse in geschlossenen Räumen bzw. bei trockenen Luftverhältnissen vorzunehmen (Feuchtigkeit und Regen vermeiden).

NL N.B.: We raden u aan de installatie- of onderhoudshandelingen van de optische behuizing binnenshuis uit te voeren, of in ieder geval in een omgeving waar geen vocht of regen is.

N.B.: Se recomienda efectuar las operaciones de instalación o mantenimiento dentro del cuerpo óptico, en interiores o por lo menos en ausencia de humedad o lluvia.

N.B. Det anbefales at udføre installation eller vedligeholdelse inden i den optiske enhed indenfor på et område fri for fugt og regn.

N.B.: Det anbefales å utgjøre installasjons- eller vedlikeholdsinngrepene inne i det optiske rommet, innendørs eller i hvert fall der det ikke finnes fuktighet eller regn.

OBS! Det anbefales å utføre installasjons- eller underhållsinterveneringer i det optiske rommet inomhus eller åtminstone i avsaknad av fukt eller regn.

RUS ПРИМЕЧАНИЕ: Рекомендуется выполнять монтаж или техническое обслуживание внутри lampового отсека в закрытых помещениях или по крайней мере в отсутствие влаги или атмосферных осадков.

CN 注释：建议在光学空间内部进行安装或者维修操作至少在内部环境或者不存在雨水或潮湿的环境。

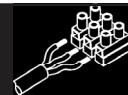
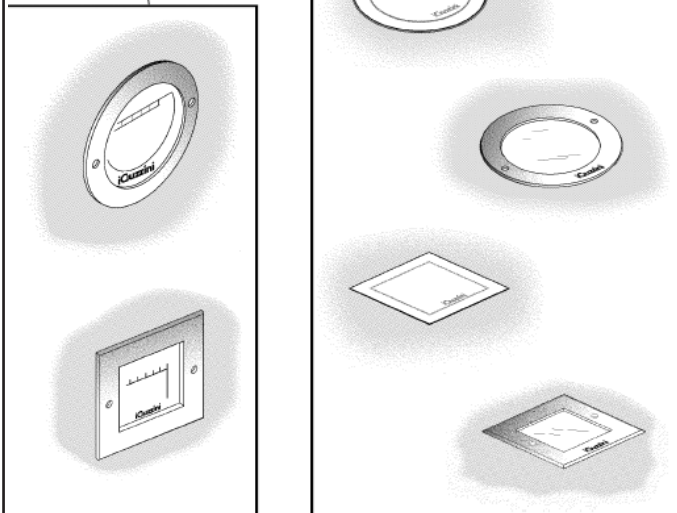
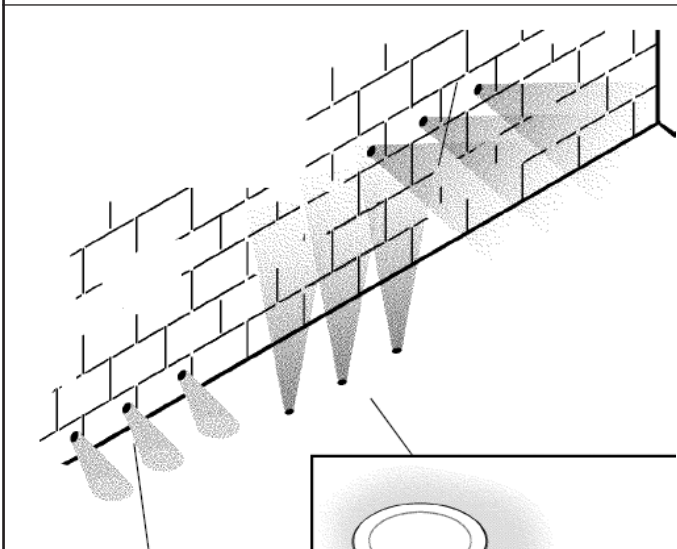
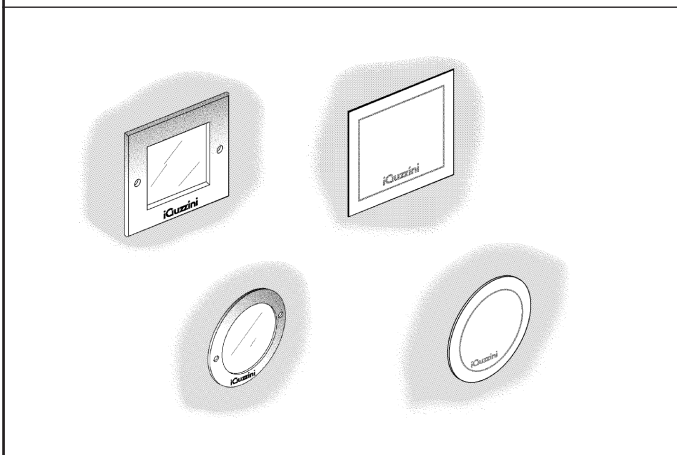

I Cablare alla rete elettrica il trasformatore solo dopo aver effettuato il collegamento ai prodotti

GB Wire the transformer to the electrical mains only after the connection to the products has been carried out

F N'effectuer le câblage au réseau électrique qu'après avoir effectué le raccordement aux produits

D Schließen Sie den Transformator erst nach der Verdrahtung an den Produkten am Stromnetz an.

E Cablear el transformador a la red eléctrica sólo después de conectar los productos

NL Verbind de transformator alleen op het elektrische net nadat u alle producten heeft aangesloten.

DK Tilslut først transformatoren til strømforsyningsnettet, efter at have foretaget tilslutningen til produkterne.

N Omformerer skal kun kobles til strømmettet etter at tilkoblingen til produktene er gjennomført.

S Anslut transformatorn till elnätet först efter att anslutningen till produkterna har utförts.

RUS Подвести кабель трансформатора к электрической сети, только после соединения с продуктами

CN 只有连接灯具后，才可以把变压器连接到电源线上。

I Si consiglia di proteggere adeguatamente il cavo dal contatto diretto con il terreno.

GB The cable should be suitably protected against direct contact with the ground.

F Nous conseillons de protéger adéquatement le câble du contact direct avec le sol.

D Es wird empfohlen, das Kabel ausreichend vor dem direkten Kontakt mit dem Erdreich zu schützen.

NL Geadviseerd wordt om de kabel adequaat te beschermen tegen direct contact met de grond.

E Se recomienda proteger adecuadamente el cable del contacto directo con el terreno.

DK Det anbefales at beskytte kablet på passende vis mod direkte kontakt med jorden.

N Vi anbefaler at kablen beskyttes tilstrekkelig fra kontakt med bakken.

S Det rekommenderas att skydda kablarna så att den inte är i direkt kontakt med marken.

RUS Рекомендуется защитить надлежащим образом кабель от прямого контакта с землей.

CN 建议采取适当的方式保护电缆，防止其与地面直接接触。

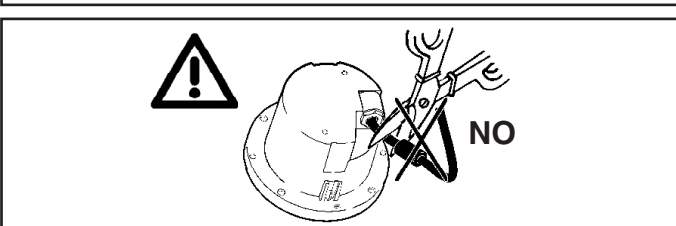
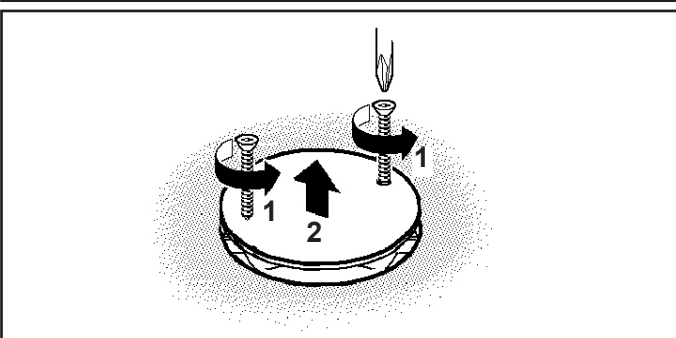

I In caso di danneggiamento del cavo elettrico con spina, la sostituzione deve essere effettuata dal costruttore, dal suo servizio di assistenza o da personale qualificato equivalente, al fine di evitare pericoli.

GB In the event of damage to the electric cable with plug, replacement must be carried out by the manufacturer, by the after-sales assistance of the same or by a qualified professional, in order to avoid all risk of danger.

F Si le câble électrique avec fiche est endommagé, faites-le remplacer par le fabricant, son service après-vente ou un professionnel du secteur, pour éviter tout risque de danger.

D Zur Vermeidung von Gefahren sind Elektrokabel und Stecker im Falle einer Beschädigung vom Hersteller, von dessen Kundendienst oder von spezialisiertem Fachpersonal auszuwechseln.

NL Mocht het elektrische snoer met stekker beschadigd raken, dan moet het vervangen ervan worden uitgevoerd door de fabrikant, zijn Technische Dienst of door een erkende installateur, teneinde gevaar te vermijden.

E En caso de daño del cable eléctrico con enchufe, la sustitución debe realizarse por el fabricante, su servicio de asistencia o bien personal especializado equivalente debido a razones de seguridad.

DK Hvis ledningen med stik beskadiges, skal den udskiftes af producenten eller er et autoriseret teknisk servicecenter, eller af kvalificerede fagfolk, så man undgår farlige situationer.

N I tilfelle skade på den elektriske kablen med plugg, må erstatning utføres av produsenten, gjennom ettersalgavdelingen til denne eller av en kvalifisert fagperson, for å unngå all fare.

S Om elkabeln med stickkontakten skadas, ska den bytas ut av tillverkaren, av dess auktoriserade verkstad eller av likvärdig kvalificerad personal för att undvika alla typer av risker.

RUS В случае повреждения электрического кабеля со штепсельной вилкой во избежание риска поручите его замену производителю, уполномоченному сервису или квалифицированному электрику.

CN 如出现带插头电缆的损坏，须由生产商、售后服务助理或资深专业人员更换新的电缆，以避免任何可能的危险。

ALIMENTAZIONE
POWER SUPPLY
ALIMENTATION
EINSPEISUNG
VOEDING
ALIMENTACIÓN
STRØMFORSYNING
STRØMTILFØRSEL
ELFORSØRJNING
ЭЛЕКТРОПИТАНИЕ
能源

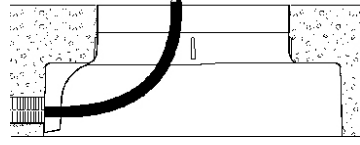
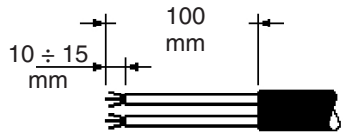

24V \equiv
220/240V \approx

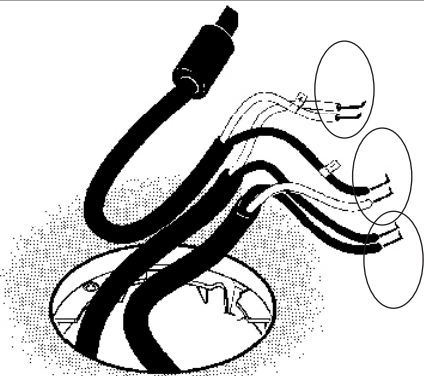
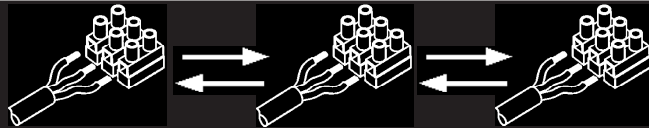
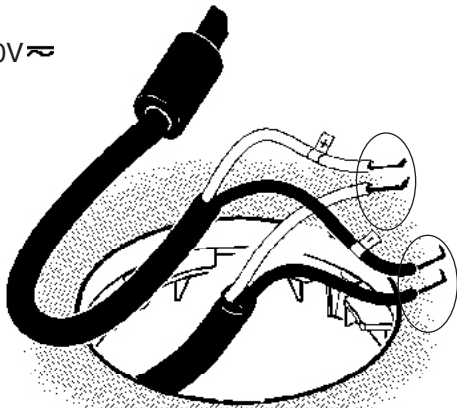

EFFECT EQUALIZER

24V \equiv
220/240V \approx

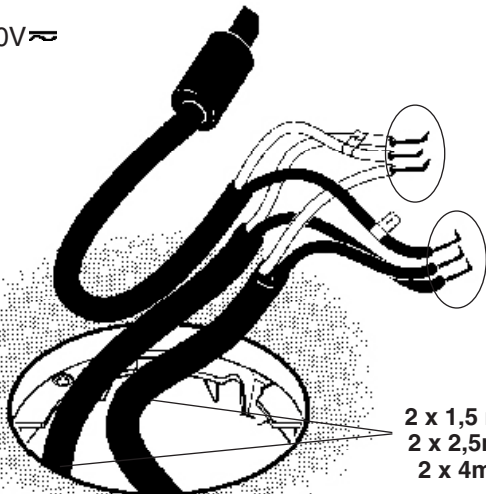

2 x 1,5 mm²
2 x 2,5mm²
2 x 4mm²

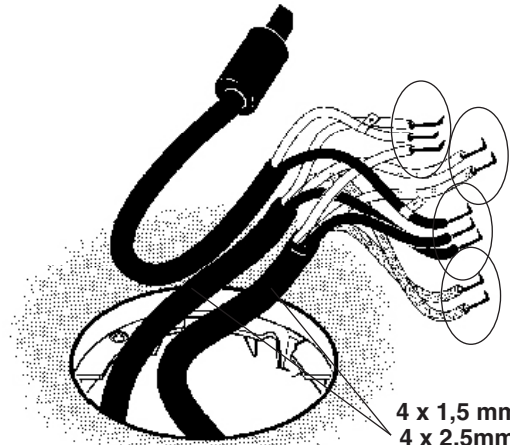

4 x 1,5 mm²
4 x 2,5mm²
4 x 4mm²

COLOUR EQUALIZER

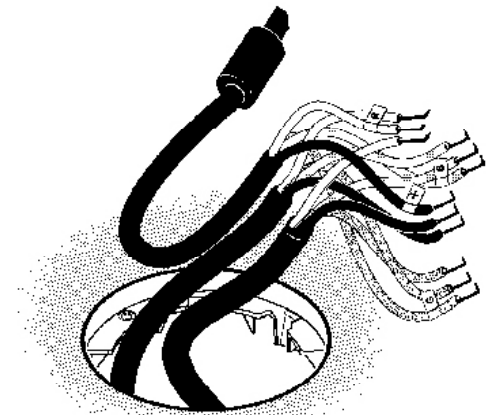

LOW VOLTAGE \equiv **A B C**
220/240V \approx **C**



LOW VOLTAGE \equiv **B C**
220/240V \approx **C**

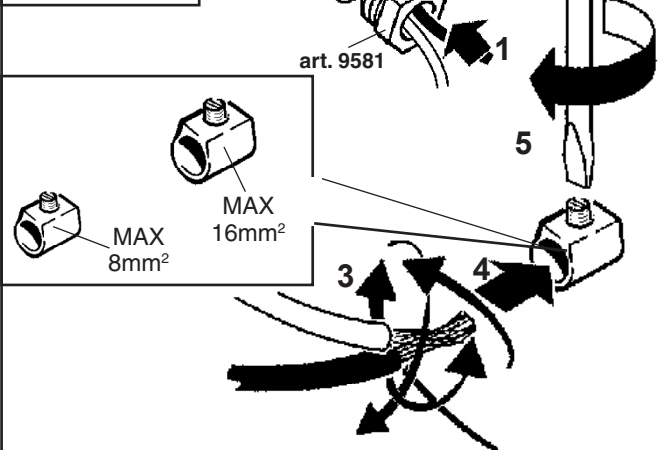
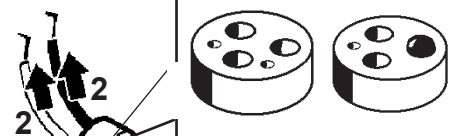
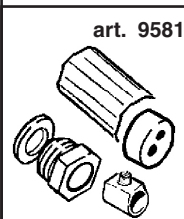

I N.B.: Verificare manualmente la tenuta dei cavi nel morsetto.
 GB N.B.: Manually check the tightness of the cables in the terminal board.
 F N.B.: Veuillez vérifier manuellement la tenue des fils dans la borne.
 D NB: Der Halt der Drähte in der Klemme ist von Hand zu prüfen.
 NL N.B.: Verifieer handmatig of de kabels goed in de klemmenstrook vastzitten.
 E N.B.: Verificar manualmente la fijación de los cables en el terminal.
 DK N.B.: Kontrollér, at ledningerne i klemmen sidder ordentligt fast.
 N N.B.: Kontrollér tettheten til kablene i terminalkortet manuelt.
 S OBS! Kontrollera för hand att kablarna sitter ordentligt fast i klämman.
 RUS ПРИМЕЧАНИЕ: Проверьте вручную прочность соединения проводов к клеммам.
 CN 注意: 手动检查接线排电缆的牢固性。

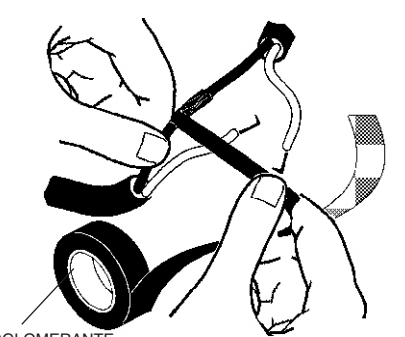

A



NASTRO AUTOAGGLOMERANTE
 SELF-VULCANISING TAPE
 RUBAN AUTO-SOUDABLE
 SELBSTHAFTBAND - (Klebefilm SCOTCH 23 3M)
 ZELFFUSERENDE TAPE
 CINTA AUTOAGGLOMERANTE (SCOTCH 23 3M)
 SELVKLÆBENDE BÅND
 SELVVULKANISERENDE TAPE
 SJÄLVBINDANDE BAND
 САМОПЛАСТИФИЦИРУЮЩАЯСЯ ЛЕНТА
 自硫化带

STAGNARE - COAT WITH TIN
 TIN ETAMER - VERZINNEN
 - VERTINNEN - ESTANAR -
 FORSEGLE - LÖD
 ЛУЖЕНЫЕ 锡焊

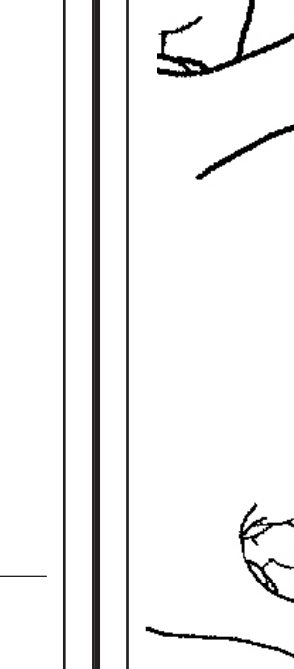
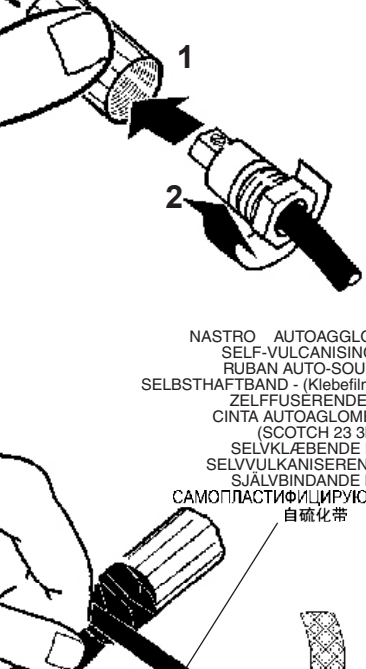
Sn

B



NASTRO AUTOAGGLOMERANTE
 SELF-VULCANISING TAPE
 RUBAN AUTO-SOUDABLE
 SELBSTHAFTBAND - (Klebefilm SCOTCH 23 3M)
 ZELFFUSERENDE TAPE
 CINTA AUTOAGGLOMERANTE (SCOTCH 23 3M)
 SELVKLÆBENDE BÅND
 SELVVULKANISERENDE TAPE
 SJÄLVBINDANDE BAND
 САМОПЛАСТИФИЦИРУЮЩАЯСЯ ЛЕНТА
 自硫化带

art. B915

C

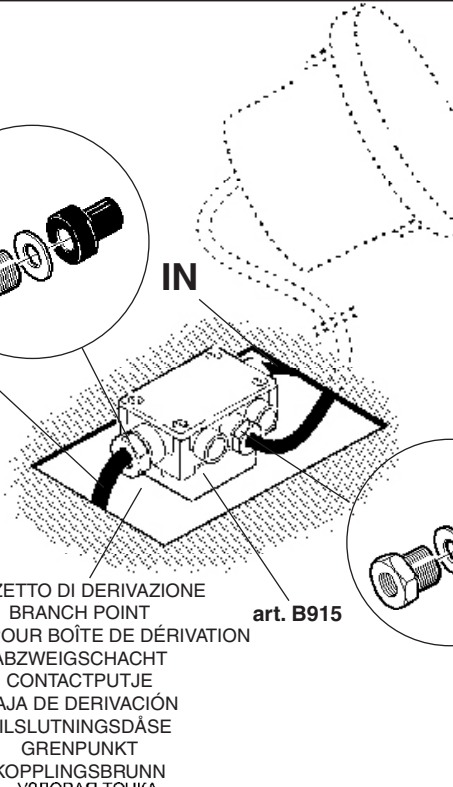

POZZETTO DI DERIVAZIONE
 BRANCH POINT
 TRAPPE POUR BOÎTE DE DÉRIVATION
 ABZWEIGSCHACHT
 CONTACTPUTJE
 CAJA DE DERIVACIÓN
 TILSLUTNINGSDÅSE
 GRENPUNKT
 KOPPLINGSBRUNN
 УЗЛОВАЯ ТОЧКА
 分支点

IN

OUT

art. B915

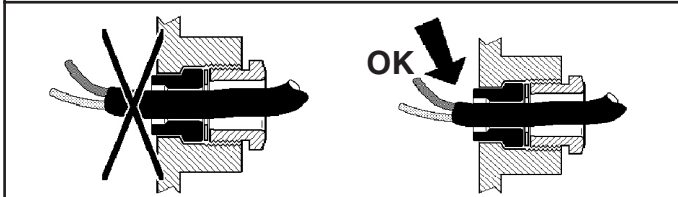
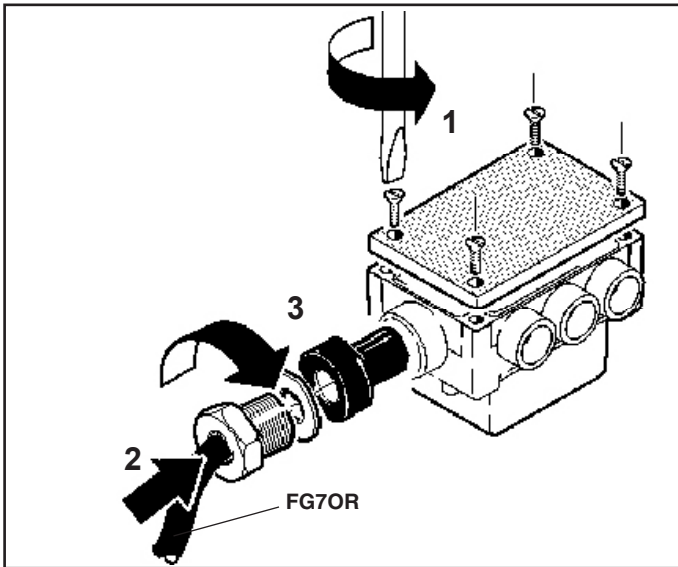

D (mm)	Ø (mm)
8,0 ÷ 10,0	8,5
10,0 ÷ 12,5	11
12,5 ÷ 14,5	13,5
14,5 ÷ 16,0	15,5

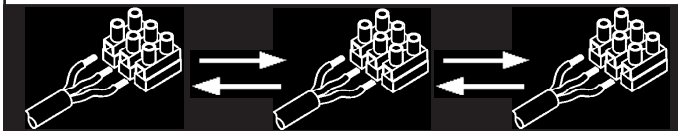
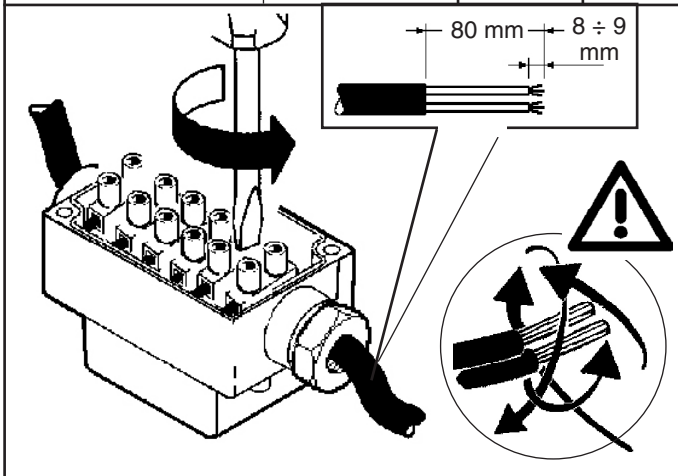

CABLAGGIO PASSANTE
 FEEDTHROUGH WIRING
 CABLAGE TRAVERSANT
 DURCHGANGSKABEL
 KABELDOORGANG
 CABLEADO PASANTE
 GENNEMGÅENDE LEDNINGER
 FØRINGSKABLING
 KABEL GENOMFØRING
 СКВОЗНОЙ МОНТАЖ
 连接线架设

FG7OR
 2 x 1,5mm²
 Ø MAX 16mm

ALIMENTAZIONE
 POWER SUPPLY
 ALIMENTATION
 EINSPEISUNG
 VOEDING
 ALIMENTACIÓN
 STRØMFORSYNING
 STRØMTILFØRSEL
 ELFÖRSÖRJNING
 ЭЛЕКТРОПИТАНИЕ
 能源

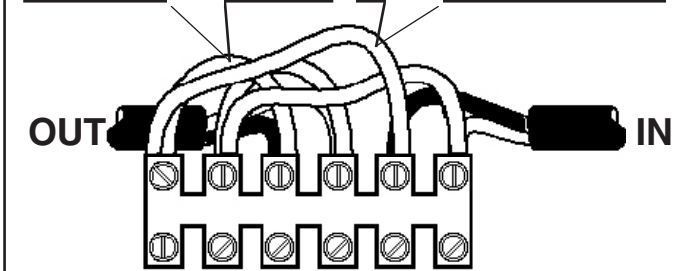
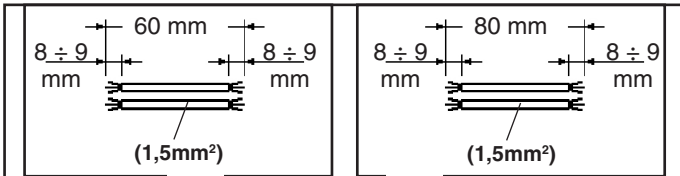

I N.B.: Verificare manualmente la tenuta dei cavi nel morsetto.
 GB N.B.: Manually check the tightness of the cables in the terminal board.
 F N.B.: Veuillez vérifier manuellement la tenue des fils dans la borne.
 D NB: Der Halt der Drähte in der Klemme ist von Hand zu prüfen.
 NL N.B.: Verifieer handmatig of de kabels goed in de klemmenstrook vastzitten.
 E N.B.: Verificar manualmente la fijación de los cables en el terminal.
 DK N.B.: Kontroller, at ledningerne i klemmen sidder ordentligt fast.
 N N.B.: Kontroller tettheten til kablene i terminalkortet manuelt.
 S OBS! Kontrollera för hand att kablarna sitter ordentligt fast i klämman.
 RUS ПРИМЕЧАНИЕ: Проверьте вручную прочность соединения проводов к клеммам.
 CN 注意: 手动检查接线排电缆的牢固性。

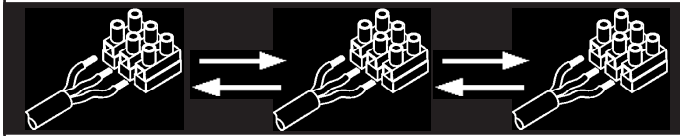

CABLAGGIO PASSANTE
 FEEDTHROUGH WIRING
 CABLAGE TRAVERSANT
 DURCHGANGSKABEL
 KABELDOORGANG
 CABLEADO PASANTE
 GENNEMGÅENDE LEDNINGER
 FØRINGSKABLING
 KABEL GENOMFØRING
 СКВОЗНОЙ МОНТАЖ
 连接线架设

FG7OR
 2 x 1,5mm²
 Ø MAX 16mm

ALIMENTAZIONE
 POWER SUPPLY
 ALIMENTATION
 EINSPEISUNG
 VOEDING
 ALIMENTACIÓN
 STRØMFORSYNING
 STRØMTILFØRSEL
 ELFÖRSÖRJNING
 ЭЛЕКТРОПИТАНИЕ
 能源

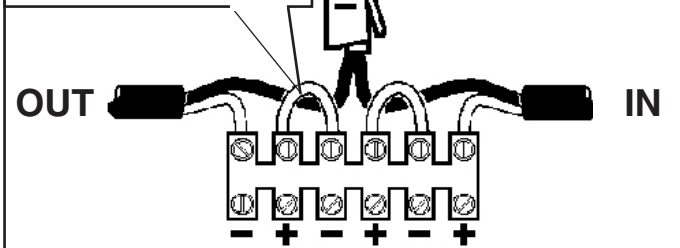
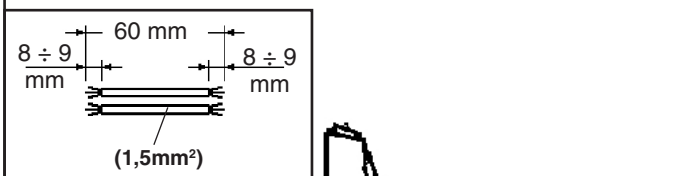

I N.B.: Verificare manualmente la tenuta dei cavi nel morsetto.
 GB N.B.: Manually check the tightness of the cables in the terminal board.
 F N.B.: Veuillez vérifier manuellement la tenue des fils dans la borne.
 D NB: Der Halt der Drähte in der Klemme ist von Hand zu prüfen.
 NL N.B.: Verifieer handmatig of de kabels goed in de klemmenstrook vastzitten.
 E N.B.: Verificar manualmente la fijación de los cables en el terminal.
 DK N.B.: Kontroller, at ledningerne i klemmen sidder ordentligt fast.
 N N.B.: Kontroller tettheten til kablene i terminalkortet manuelt.
 S OBS! Kontrollera för hand att kablarna sitter ordentligt fast i klämman.
 RUS ПРИМЕЧАНИЕ: Проверьте вручную прочность соединения проводов к клеммам.
 CN 注意: 手动检查接线排电缆的牢固性。

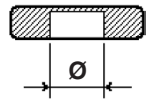
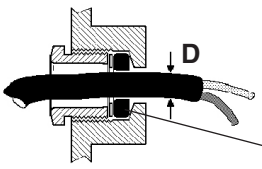
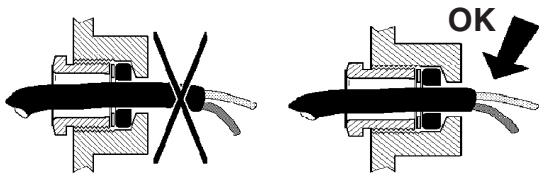
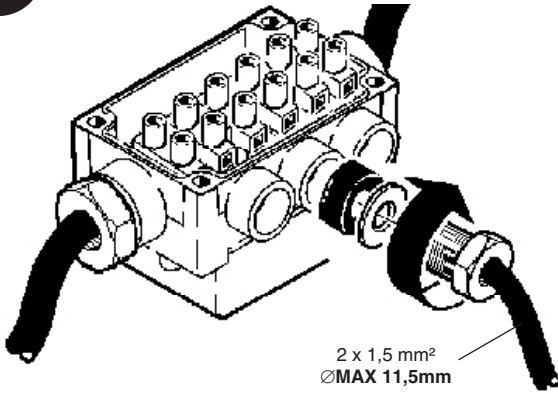
D

D (mm)	Ø (mm)
3,0 ÷ 5,0	3,9
6,5 ÷ 9,0	8,0
9,0 ÷ 11,5	10,5

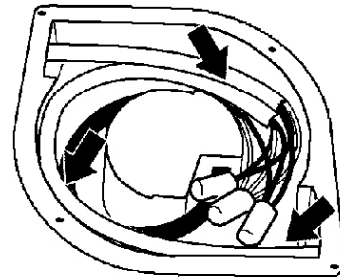
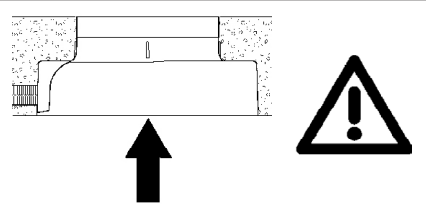
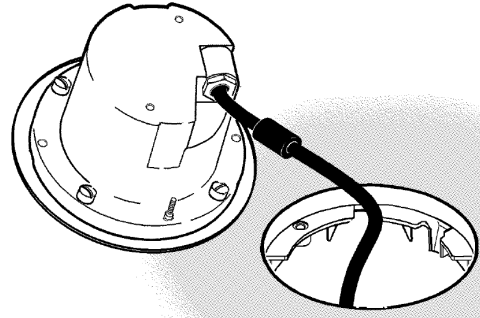
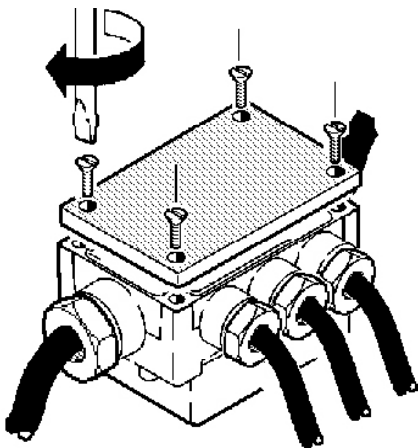
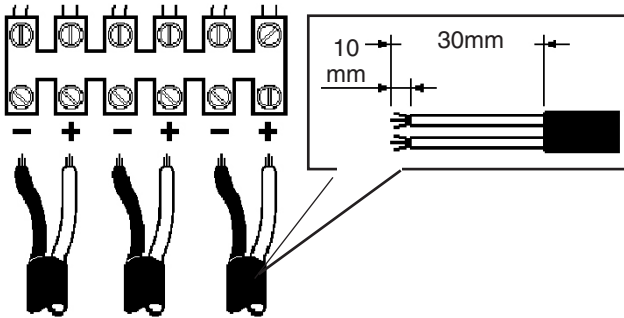

- I Disporre i cavi ai lati dell'apparecchio come indicato in figura.
- GB Arrange the cables on the sides of the luminaire as indicated in the figure.
- F Placez les câbles sur les côtés de l'appareil comme illustré (voir figure).
- D Ordnen Sie die Kabel wie in der Abbildung dargestellt an den Seiten der Leuchte an.
- NL Plaats de kabels aan de zijanten van het apparaat zoals aangegeven in de afbeelding.
- E Coloque los cables a los costados del aparato como lo indica la figura.
- DK Anbring ledningerne på siderne af armaturet, som vist i figuren.
- N Plasser kablene på siden av lysarmaturen slik som indikert på figuren.
- S Placera kablar på utrustningens sidor, som visas i figuren.
- RUS Расположите провода по бокам прибора, как показано на схеме.
- CN 如图所示在灯具侧排列电缆。

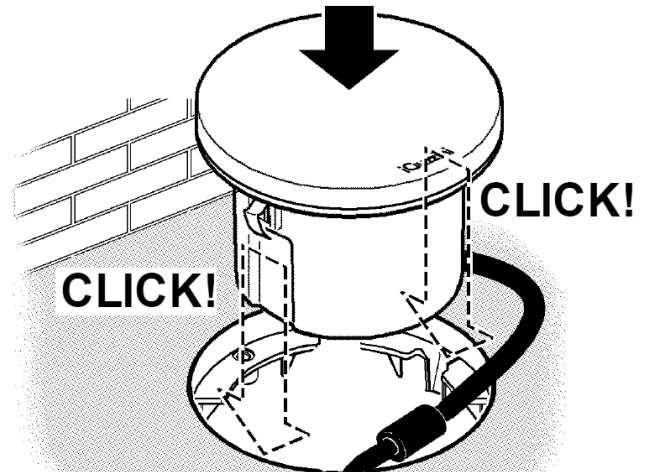

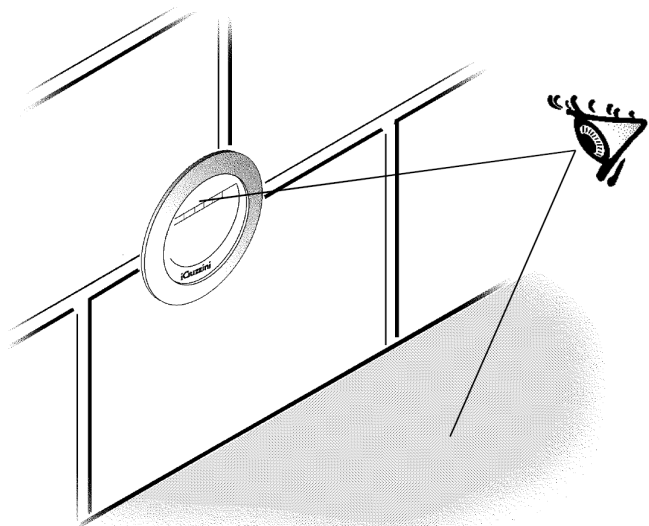
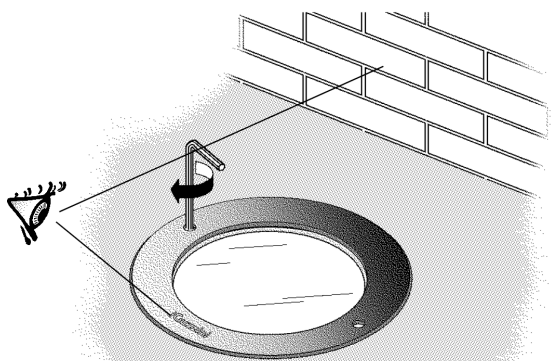
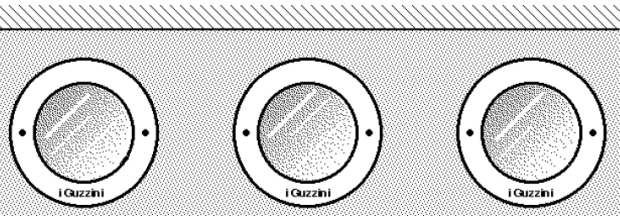
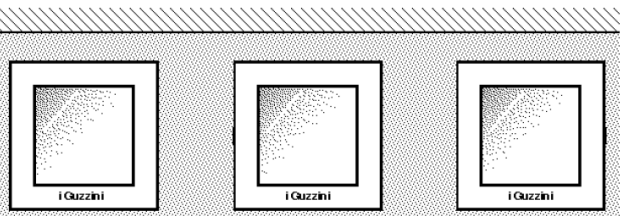

art. B281 - B319
B300 - B337
BB43 - BB44
BB45 - BB46
BB47 - BB48
BB49 - BB50

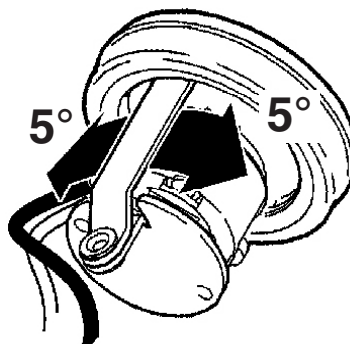
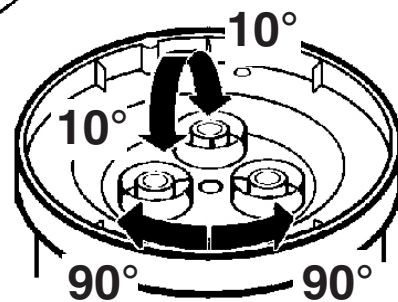
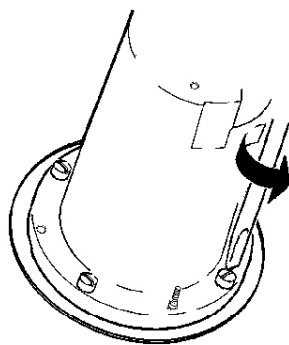

art. 9583

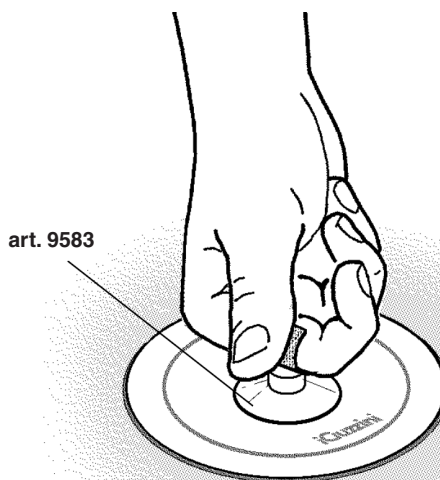

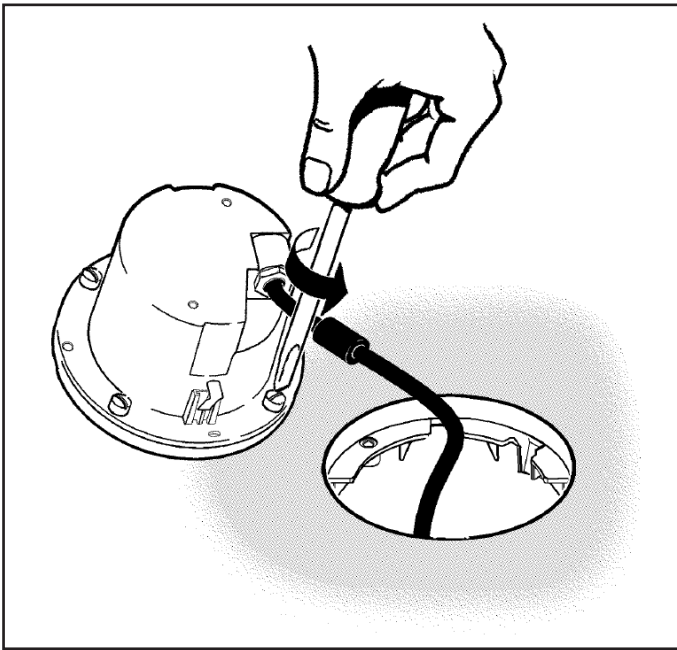

ART.	Filtro-Filter-Filtre Filter - Filter - Filtro Filter - Filter - Filtro Фильтр 濾色鏡	PITTOGRAMMA PICTOGRAM PICTOGRAMME PIKTOGRAMM PICTOGRAMA PIKTOGRAM PIKTOGRAM BILDTECKEN ПИКТОГРАММА 象形图					
	Colorato - Coloured - Couleur Farbig - Gekleurd - Colorado Farvet - Färgat - Цветной 彩色的 Diffondente - Diffusing - Diffuseur für diffuses Licht - Verspreidend - Difusor Lysspredning - Spreddning - Ljusdiffusionsglas Рассеиватель света 漫射						
2606 - 2607 - 2609	9568	-	-	-	-	-	-
2611 - 2612 - 2614 B276 - B278 - B285 B286 - BD72	-	-	-	-	-	-	-
2628 - 2629 - 2631 BD71 - B275	9570 9569	-	9584	9585	9586	9587	9588
B281 - BB43 - BB44	-	9569	-	-	-	-	-
B319 - BB45 - BB46 B328	-	9571	-	-	-	-	-
	-	-	9594	9595	9596	9597	9598

ART.	Filtro-Filter-Filtre Filter - Filter - Filtro Filter - Filter - Filtro Фильтр 濾色鏡	PITTOGRAMMA PICTOGRAM PICTOGRAMME PIKTOGRAMM PICTOGRAMA PIKTOGRAM PIKTOGRAM BILDTECKEN ПИКТОГРАММА 象形图					
	Colorato - Coloured - Couleur Farbig - Gekleurd - Colorado Farvet - Färgat - Цветной 彩色的 Diffondente - Diffusing - Diffuseur für diffuses Licht - Verspreidend - Difusor Lysspredning - Spreddning - Ljusdiffusionsglas Рассеиватель света 漫射						
2620 - 2621 - 2623	9572	-	-	-	-	-	-
2635 - 2636 2638 - 2640 BD73 - B294	9574 9573	9572	9589	9590	9591	9592	9593
B295 - B297 - B304 B305 - BD74	-	-	-	-	-	-	-
B300 - BB47 - BB48	-	9573	-	-	-	-	-
B337 - BB49 - BB50 B346	-	9575	-	-	-	-	-
	-	-	9608	9609	9610	9611	9612

art. 2628 - 2629 - 2631 - 2635 - 2636 - 2638 - 2640

- I E' possibile installare un pittogramma ed un filtro colorato.
- GB A pictogram and coloured filter may be installed.
- F Il est possible d'installer un pictogramme et un filtre coloré.
- D Es kann sowohl ein Piktogramm als auch ein Farbfilter installiert werden.
- NL Het is mogelijk een pictogram en een gekleurd filter te installeren.
- E Se pueden instalar un pictograma y un filtro cromático.
- DK Der kan installeres et piktogram og et farvefilter.
- N Et piktogram og farget filter kan installeres.
- S Det går att installera ett piktogram och ett färgat filter.
- RUS Можно установить одну пиктограмму и один цветной фильтр.
- CN 可安装象形图和彩色滤光器。

- GIALLO
YELLOW
JAUNE
GELB
GELB
GELB
AMARILLO
GUL
GUL
GUL
ЖЕЛТЫЙ
黄色
- CIANO
CYAN
CYAN
ZYAN
ZACHTBLA
AZULADO
BLÁVIOLET
KORNBLÁ
CYAN
ВАСИЛЬКОВЫЙ
青色
- ARANCIO
ORANGE
ORANGE
ORANGE
ORANJE
ORANGE
ORANGE
ORANGE
ORANSJE
ORANGE
ОРАНЖЕВЫЙ
橘黄色
- OSCURATO
DARKENED
SOMBRE
VERDUNKELT
VERDUISTERD
OSCURECIDO
FORMØRKET
FORMØRKET
MÖRKLADG
НЕ ОСВЕЩЕННЫЙ
变暗的
- MAGENTA
MAGENTA
MAGENTA
MAGENTA
MAGENTA
RÖDVIOLET
MAGENTARØD
MAGENTA
ПУРПУРНЫЙ
洋红色

☰	art. 9584 - 9589 9594 - 9608
☷	art. 9585 - 9590 9595 - 9609
ⓘ	art. 9586 - 9591 9596 - 9510
➔	art. 9587 - 9592 9597 - 9611
♂♀	art. 9588 - 9593 9598 - 9612

**SOSTITUZIONE DEL LED
REPLACING THE LED
REPLACEMENT DE LA LED
AUSTAUSCHEN DER LED
VERVANGEN VAN DE LED
REEMPLAZO DEL LED
UDSKIFTNING AF LYSDIODE
BYTE AV LYSDIOD
UTSKIFTING AV DEN LYSEMITTERENDE DIODEN
ЗАМЕНА СИД
发光二极管替换**

I N.B.: Per la sostituzione del LED contattare l'azienda iGuzzini.

GB N.B.: For information on LED replacement please contact iGuzzini.

F N.B.: Pour procéder au remplacement de la LED, adressez-vous à la société iGuzzini.

D N.B.: Bezüglich des Austausches der LED kontaktieren Sie bitte die Firma iGuzzini.

NL N.B.: Voor het vervangen van de LED neemt u contact op met het bedrijf iGuzzini.

E NOTA: Para sustituir el LED llame a la empresa iGuzzini.

DK N.B.: For udskiftning af lysdioden, skal man kontakte iGuzzini.

N N.B.: For informasjon om skifte av LED, vennligst ta kontakt med iGuzzini.

S OBS! För byte av lysdioden, kontakta företaget iGuzzini.

RUS ПРИМЕЧАНИЕ: Для замены СИДов обращайтесь в компанию iGuzzini.

CN 注意：如需LED更换的信息，请联系iGuzzini。

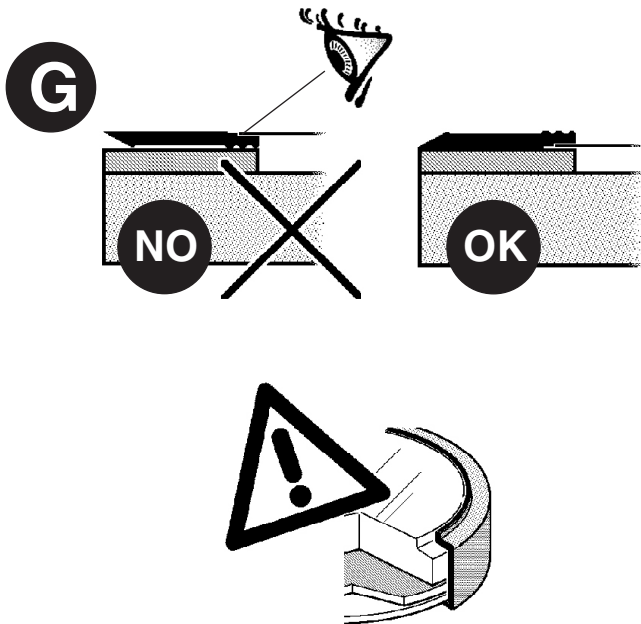

I Assicurarsi che la guarnizione "G" sia posizionata come in figura.

GB Make sure that the seal "G" is positioned as shown in the figure.

F Contrôlez que le joint "G" est bien monté comme illustré par la figure.

D Achten Sie darauf, daß die Dichtung "G" so wie in der Abbildung veranschaulicht aufgelegt wird.

NL Let erop dat de afdichting "G" geplaatst wordt zoals in de afbeelding.

E Comprobar que la junta "G" resulte en la posición indicada en figura.

DK Kontroller, at pakningen "G" sidder, som vist i figuren.

N Se til at forseglingen "G" er posisjonert slik som vist på figuren.

S Försäkra dig om att packningen "G" sitter korrekt som i figuren.

RUS Проверьте, чтобы уплотнение «G» было установлено, как показано на схеме.

CN 确认封条"G"如图所示放置。

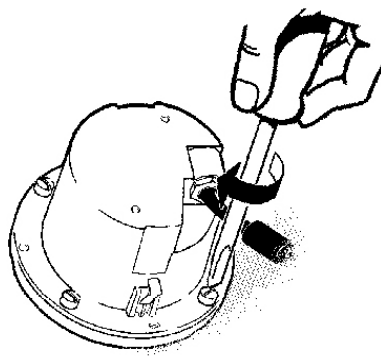

I Serrare le viti "V" passando da una vite a quella diametralmente opposta, accertandosi che siano posizionate al centro delle rispettive sedi sul prodotto.

GB Tighten screws "V" going from one screw to the one which is diametrically opposite, making sure that they are located in the centre of their respective housings on the product.

F Serrez les vis «V» dans l'ordre suivant: passez d'une vis à celle qui lui est diamétralement opposée et contrôlez qu'elles sont bien centrées dans leurs logements respectifs prévus sur le produit.

D Ziehen Sie die Schrauben „V“ zu, indem Sie immer erst eine Schraube, dann die ihr gegenüberliegende fest ziehen und sich dabei vergewissern, dass sich die Schrauben genau in der Mitte des auf dem Artikel vorgesehenen Loches befinden.

NL Draai de schroeven "V" aan, van een schroef naar de diametrisch tegenovergelegen, en let erop dat ze in het midden van hun respectievelijke behuizingen op het apparaat worden aangebracht.

E Apretar los tornillos «V» pasando de un tornillo al tornillo diametralmente opuesto, asegurándose de que los tornillos están colocados en el centro de sus sedes en el producto.

DK Spænd skruerne "V" i en diametral rækkefølge, og sørg for, at de sidder midt i deres sæder på produktet.

N Trekk til skruene "V" ved å gå fra én skruer til den som er diametrisk motsatt, slik at de plasseres i senter av respektive hus på produktet.

S Dra åt skruvarna "V". Korsdra dem och försäkra dig om att de sitter i mitten i förhållande till respektive säten på utrustningen.

RUS Закрутите шурупы "V", переходя от одного шурупа к противоположному, проверяя, чтобы шурупы были расположены в центрах своих гнезд в приборе.

CN 依次拧紧螺丝“V”，包括相对的螺丝，确认螺丝安置于产品上各自壳体的中心。

- I Le condizioni ottimali di funzionamento dell'apparecchio sono garantite soltanto per oscillazioni della tensione in uscita dall'alimentatore del $\pm 2\%$ rispetto al valore nominale. La conformità alla norma è garantita soltanto utilizzando trasformatori iGuzzini (art.: 9907 - 9908 - 9909 - 9910 - 9911 - 9912) od equivalenti di tipo SELV che rispondano alle vigenti norme C.E.I. Per l'installazione dei trasformatori è possibile utilizzare la scatola di derivazione art.9582.
- GB The optimum operating conditions for the fixture are guaranteed only if the ballast output voltage oscillations are $\pm 2\%$ in relation to the nominal value. Conformity with the standard is guaranteed only if either iGuzzini transformers (item code 9907 - 9908 - 9909 - 9910 - 9911 - 9912) or equivalent SELV type transformers which comply with current C.E.I. regulations are used. Connector block item 9582 can be used for transformer installation.
- F Les conditions optimales de fonctionnement de l'appareil ne sont assurées que pour des oscillations de la tension de sortie du ballast de $\pm 2\%$ par rapport à la valeur nominale. La conformité à la norme n'est assurée qu'en cas d'utilisation de transformateurs iGuzzini (réf.: 9907 - 9908 - 9909 - 9910 - 9911 - 9912) ou équivalents type SELV conformes aux normes C.E.I. Pour l'installation des transformateurs il est possible d'utiliser la boîte de dérivation réf. 9582.
- D Die optimalen Bedingungen für den Betrieb der Leuchte sind nur für vom Vorschaltgerät abgehende Spannungsschwankungen von $\pm 2\%$ in Bezug auf den Nennwert gewährleistet. Die Übereinstimmung mit der Norm ist nur gewährleistet, wenn Transformatoren von iGuzzini (Art.: 9907 - 9908 - 9909 - 9910 - 9911 - 9912) oder entsprechende vom Typ SELV verwendet werden, welche die gültigen C.E.I.-Normen erfüllen. Zur Installation der Transformatoren kann die Abzweigdose Art.9582 verwendet werden.
- NL De optimale condities voor de werking van het apparaat zijn alleen gegarandeerd voor uitgaande spanningsvariëaties van $\pm 2\%$ ten opzichte van de nominale waarde van het voorschakelapparaat. De conformiteit aan de norm wordt alleen gegarandeerd als u iGuzzini voorschakelapparaten gebruikt (art.: 9907 - 9908 - 9909 - 9910 - 9911 - 9912) of overeenkomstige van het type SELV, die aan de geldende C.E.I. normen voldoen. Voor het installeren van de transformatoren kunt u de aftakdoos art.9582 gebruiken.
- E Las condiciones de funcionamiento optimales del aparato se garantizan solamente con oscilaciones de la tensión de salida del alimentador de $\pm 2\%$ respecto al valor nominal. La conformidad a la norma se garantiza solamente con el uso de transformadores iGuzzini (art. 9907 - 9908 - 9909 - 9910 - 9911 - 9912) o equivalentes de tipo SELV que cumplen las normas vigentes C.E.I. Para la instalación de los transformadores se puede utilizar la caja de derivación art.9582.
- N Optimal driftsbetingelse for armaturen sikres kun hvis svingningene av ballastens utmatingspenninger er $\pm 2\%$ i forhold til nominell verdi. Overhold av standarden garanteres kun hvis enten iGuzzini-transformere (art. 9907 - 9908 - 9909 - 9910 - 9911 - 9912) eller tilsvarende transformere (SELV-type) som møter C.E.I.-kravene som gjelder brukes. Kontaktblokk artikkel 9582 kan brukes til transformerinstallasjon.
- DK Armaturet kan kun fungere optimalt, hvis det maksimale udgangsspændingsudsving ligger mellem $\pm 2\%$ i forhold til den nominelle værdi. Opfyldelse af reglerne garanteres kun ved brug af transformatorer fra iGuzzini (art.: 9907 - 9908 - 9909 - 9910 - 9911 - 9912) eller lignende af typen SELV, der opfylder de gældende CEI-regler. For installation af transformatorerne kan man bruge samledåsen art.9582.
- S Utrustningens optimala driftförhållanden garanteras endast vid en matningsspänningsoscillation vid utgången på $\pm 2\%$ i förhållande till nominell värde. Överensstämmelse med standard garanteras endast genom att använda transformatorer av typ iGuzzini (art.: 9907 - 9908 - 9909 - 9910 - 9911 - 9912) eller motsvarande av typ SELV som överensstämmer med gällande C.E.I.-standard. För installationen av transformatorerna, kan kopplingsdosan art. 9582 användas.
- RUS Оптимальные рабочие условия прибора гарантируются только в случае колебания напряжения на выходе из блока питания на $\pm 2\%$ по отношению к номинальному значению. Соответствие нормативу гарантируется только при использовании трансформаторов iGuzzini (арт.: 9907 - 9908 - 9909 - 9910 - 9911 - 9912) или подобных типа SELV, отвечающих требованиям действующих нормативов ЕЭС. Для монтажа трансформаторов можно использовать ответвительную коробку арт. 9582.
- CN 只有在供电输出强度符合额定数据 $\pm 2\%$ 的情况下,该装置才能够以最好条件的运转。产品的合格性只有以下情况可以保证:使用 iGuzzini (9907 - 9908 - 9909 - 9910 - 9911 - 9912 产品)的变压器或者遵守 C.E.I. 现行规定的 SELV 种类。在安装变压器的时候可以使用 9582 号产品分线盒。
- I Per progetti d'impianto personalizzati l'azienda iGuzzini fornisce, previa documentazione necessaria, i dati relativi al numero dei prodotti installabili e la lunghezza dei cavi, in funzione dell'alimentatore e del tipo di cavo utilizzato.
- GB For customised installation projects iGuzzini is able to supply - accompanied by the necessary documentation - details relating to the number of installable products and the length of the cables based on the ballast and type of cable used.
- F Pour des projets d'installation personnalisés, veuillez transmettre la documentation nécessaire à l'entreprise iGuzzini, qui s'occupera d'indiquer le nombre de produits à installer ainsi que le longueur des câbles, en fonction du ballast et du type de câble utilisés.
- D Für personalisierte Anlagenprojekte liefert das Unternehmen iGuzzini nach Vorlage der erforderlichen Dokumentation die Angaben bezüglich der Anzahl der installierbaren Leuchten sowie die Kabellänge in Abhängigkeit vom Vorschaltgerät und von der Art des verwendeten Kabels.
- NL Na ontvangst van het benodigde documentatiemateriaal kan het bedrijf iGuzzini bij gepersonaliseerde installatieontwerpen informatie verschaffen betreffende het aantal installeerbare producten en de lengte van de kabels voor het voorschakelapparaat, aan de hand van het type kabel wat gebruikt zal worden.
- E Para proyectos personalizados y previo conocimiento de la documentación necesaria, iGuzzini puede suministrar datos sobre el número de productos a instalar y la longitud de los cables en función del alimentador y del tipo de cable utilizado.
- N For spesialtilpassede installasjonsprosjekter er iGuzzini i stand til å levere - sammen med den nødvendige dokumentasjonen - detaljene på installerbare produkter og lengden på kablene basert på ballast og type kabel som brukes.
- DK Ved skreddersyede anlæg fremsender iGuzzini dokumentation med alle oplysninger vedrørende antallet af produkter, der kan installeres, og kabellængde, alt efter typen af strømforsyning og kabel.
- S För kundanpassade installationer tillhandahåller iGuzzini (efter nödvändig dokumentation) data angående antalet produkter som kan installeras och kablarnas längd, beroende på typen av strömförsörjningsanordning och kabel som används.
- RUS Для индивидуальных проектов осветительных систем, после получения всей необходимой документации заказчика, Компания iGuzzini предоставляет сведения о количестве изделий, которые могут быть установлены, и о длине проводов в зависимости от блока питания и от типа используемого провода.
- CN 对于 iGuzzini 公司个性化的装配系统设计, 根据所使用的供电电器以及电线的种类,提供有关文件, 安装的产品数据以及电线的长度。

**COLLEGAMENTO IN PARALLELO
PARALLEL CONNECTION
BRANCHEMENT EN PARALLÈLE
PARALLELSCHALTUNG
PARALLELSCHAKELING
CONEXIÓN EN PARALELO
PARALLELFORBINDELSE
PARALLELLKOPLING
PARALLELLKOPPLING
ПАРАЛЛЕЛЬНОЕ СОЕДИНЕНИЕ
并联**

N° Prodotti collegabili / Sezione cavo
No. of products that can be connected / Cable cross section.
Nombre de Produits reliables / Section câble
Anzahl der Strahler, die miteinander verbunden werden können / Kabeldurchschnitt
N° Verbindbare producten/Doorsnee kabel
N° de productos a conectar/Sección del cable
Antal produkter der kan tilsluttes / Kabelsnitt
Antall produkter som kan tilkoples / kabeltverrsnitt.
Antal produkter som kan anslutas/kabeltvärsnitt
Кол-во подсоединяемых приборов / Сечение провода
可连接的产品编号/电缆横截面

INCASSO - RECESSED APPLICATION TROU D'ENCASTREMENT - EINBAU INBOUW - EMPOTRABLE VEGGMONTERING - INDBYGNING INBYGGNAD LAMPADA ВСТРОЕННЫЙ МОНТАЖ ЛАМПА 嵌入 光源	LAMP LAMPE LAMPE LAMPE LAMPARA LYSKILDE LAMPE LAMPA ЛАМПА 光源 (W)	Sezione Section Section Querschnitt Doorsnede Sección Snit Avsnitt Tvärsnitt Сечение 安装区域 (mm ²)	ALIMENTATORE - BALLAST - BALLAST - VORSCHALTGERÄT VOORSCHAKELAPPARAAT - ALIMENTADOR - STRØMFORSYNINGSENHED BALLAST - STRØMFÖRSÖRJNINGSANORDNING БЛОК ПИТАНИЯ 电源							
			ART. 9908 (9,6W)		ART. 9909 (24W)		ART. 9910 (72W)		ART. 9911 (96W)	
			(N°)	L(m)	(N°)	L(m)	(N°)	L(m)	(N°)	L(m)
2600-2601-2602-ED70	0,4	1,5	24	900	60	350	182	120	/	/
2603-2604	0,55	1,5	18	1000	46	400	138	140	/	/
2606 - 2607 - 2608 2620 - 2621 - 2622 B275 - B276 - B277 B294 - B295 - B296 BD71 - BD73 - ED66 ED67	0,75	1,5 2,5 4	13	300 500 /	33	150 250 /	90	50 80 /	/	/
2609 - 2610 - 2623 B278 - B279 - B297 B298	0,7	1,5 2,5 4	14	150 250 /	35	60 100 /	60	35 55 /	/	/
2611 - 2612 - 2613 B285 - B286 - B287 B304 - B305 - B306 BD72 - BD74 - ED71	0,4	1,5 2,5 4	24	350 600 /	60	150 250 /	126	70 120 /	/	/
2614 - 2615 - B288 B289 - B307 - B308	0,4	1,5 2,5 4	24	600 1200 /	60	300 500 /	126	150 250 /	/	/
2628 - 2629 - 2630 2635 - 2636 - 2637 B313 - B314 - B315 B331 - B332 - B333 ED68 - ED69	1,5	1,5 2,5 4	6	300 600 900	16	150 250 350	49	45 80 120	/	/
2631 - 2632 - 2638 2639 - B316 - B317 B334 - B335	1,4	1,5 2,5 4	7	150 250 350	17	60 100 160	40	25 40 65	/	/
B349 - B350 - B351	0,8	1,5 2,5 4	12	300 600 900	30	150 250 350	90	45 80 120	/	/
B352 - B353	0,85	1,5 2,5 4	11	150 250 350	29	60 100 150	60	25 40 70	/	/
B367 - B368 - B369	2,45	1,5 2,5 4	4	300 600 900	10	150 250 350	30	50 80 120	40	35 60 90
B370 - B371	2,5	1,5 2,5 4	3	150 250 350	9	60 100 160	29	20 35 5	39	15 25 35
B385 - B386 - B387	4,1	1,5 2,5 4	2	300 600 900	6	150 250 350	18	50 80 120	24	35 60 90
B388 - B389	4,2	1,5 2,5 4	2	150 250 350	5	60 100 160	17	20 45 50	23	15 25 40

ALIMENTATORE
BALLAST
BALLAST
VORSCHALTGERÄT
VOORSCHAKELAPPARAAT
ALIMENTADOR
STRØMFORSYNINGSENHED
BALLAST
STRØMFØRSØRJNINGSANORDNING
БЛОК ПИТАНИЯ
电源

24V \equiv
220/240V \sim

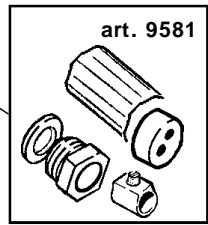
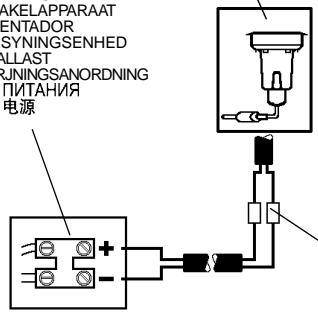

ALIMENTATORE
BALLAST
BALLAST
VORSCHALTGERÄT
VOORSCHAKELAPPARAAT
ALIMENTADOR
STRØMFORSYNINGSENHED
BALLAST
STRØMFØRSØRJNINGSANORDNING
БЛОК ПИТАНИЯ
电源

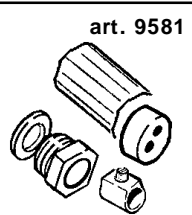
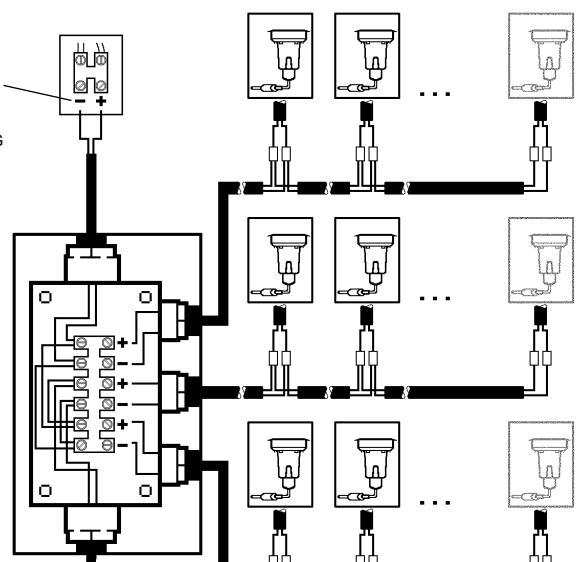

24V \equiv
220/240V \sim

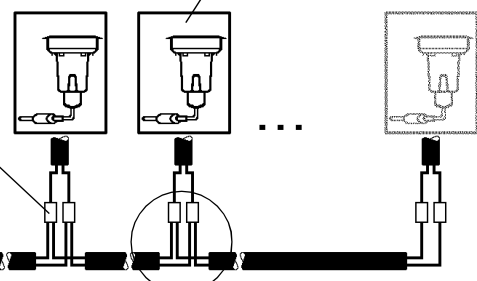

24V \equiv
220/240V \sim

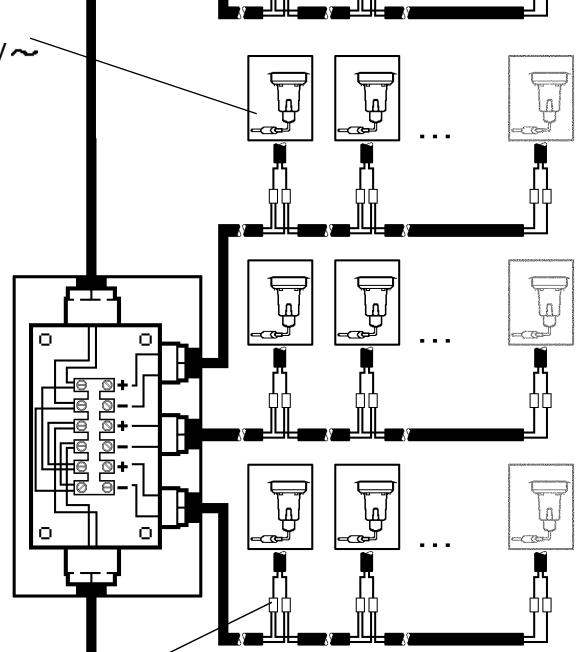

ALIMENTATORE
BALLAST
BALLAST
VORSCHALTGERÄT
VOORSCHAKELAPPARAAT
ALIMENTADOR
STRØMFORSYNINGSENHED
BALLAST
STRØMFØRSØRJNINGSANORDNING
БЛОК ПИТАНИЯ
电源

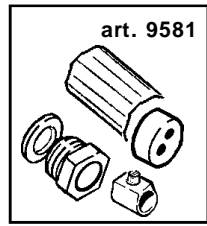
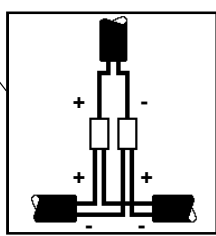

art. B915
SCATOLA DI DERIVAZIONE
CONNECTOR BLOCK
BOITE DE DÉRIVATION
ABZWEIGDOSE
CONTACTDOOS
CAJA DE DERIVACIÓN
SAMLEDÅSE
KONTAKTBLOKK
KOPPLINGSDOSA
ОТВЕТВИТЕЛЬНАЯ КОРОБКА
分线盒

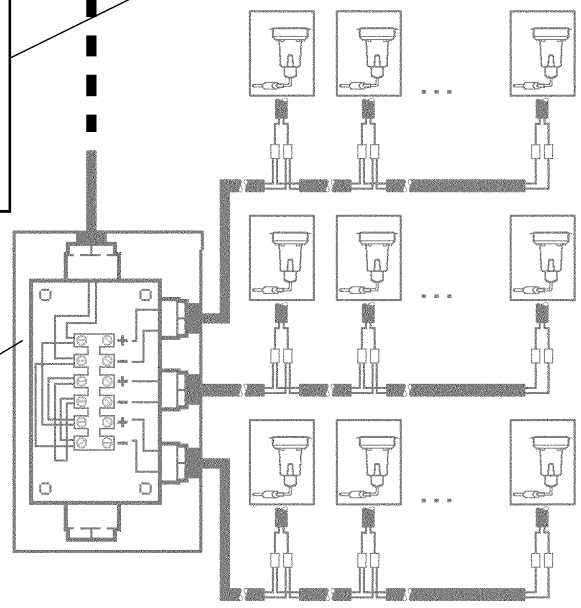

COLLEGAMENTO IN SERIE
 SERIES CONNECTION
 BRANCHEMENTEN SÉRIE
 REIHENSCHALTUNG
 SERIESCHAKELING
 CONEXIÓN EN SERIE
 SERIEFORBINDELSE
 SERIETILKOPLINGEN
 SERIEKOPPLING
 ПОСЛЕДОВАТЕЛЬНОЕ СОЕДИНЕНИЕ
 相关系列

INCASSO - RECESSED APPLICATION TROU D'ENCASTREMENT - EINBAU INBOUW - EMPOTRABLE VEGGMONTERING - INDBYGNING INBYGGNAD ВСТРОЕННЫЙ МОНТАЖ 嵌入	LAMPADA LAMP LAMPE LAMPE LAMP LÁMPARA LYSKILDE LAMPE LAMPA ЛАМПА 光源 (W)	Sezione cavo Cable cross section. Section câble Kabeldurchschnitt Doorsnee kabel Sección del cable Kabelsnit kabelversnitt. kabelvársnitt Сечение провода 电缆横截面	ALIMENTATORE BALLAST VORSCHALTGERÄT VOORSCHAKELAPPARAAT ALIMENTADOR STRØMFORSYNINGSENHED BALLAST STRÖMFÖRSÖRJNINGSENHED БЛОК ПИТАНИЯ 电源		ART. 9905 (7W)	
			ART.	(mm ²)	N°	L (m)
B280 - B281 - B282 B299 - B300 - B301 BB43 - BB44 - BB47 BB48	1	1,5	11	200	7	200
B283 - B284 B302 - B303	1	1,5	13	200		

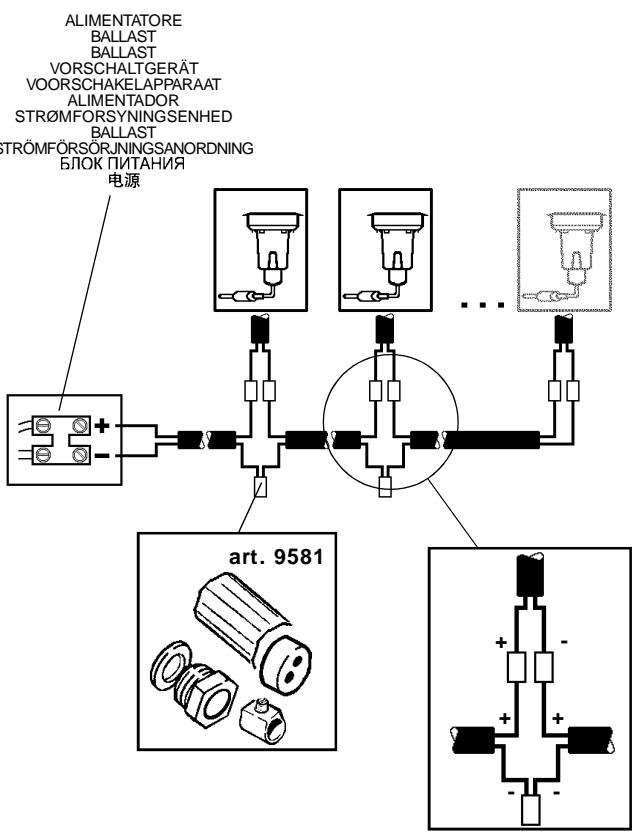
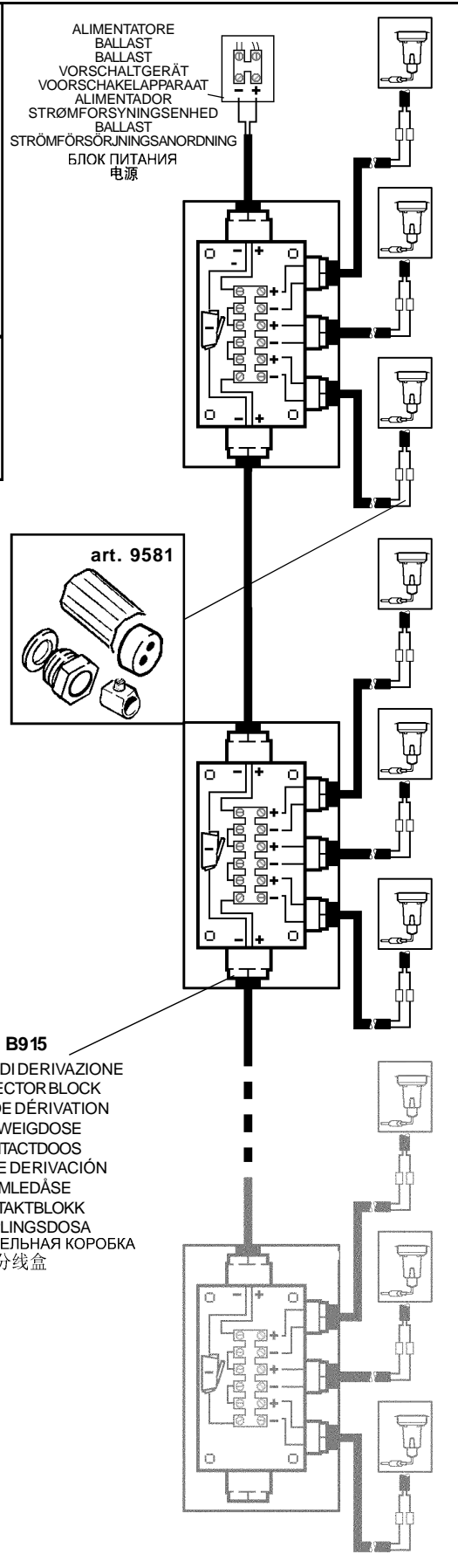

EFFECT EQUALIZER

DATI TECNICI PER L'IMPIANTO A 6 LINEE - TECHNICAL DATA FOR A 6-LINE SYSTEM
DONNÉES TECHNIQUES POUR L'INSTALLATION À 6 LIGNES - TECHNISCHE ANGABEN FÜR DIE ANLAGE MIT 6 LEITUNGEN
TECHNISCHE GEVEENS VOOR DE INSTALLATIE MET 6 LIJNEN - DATOS TÉCNICOS PARA INSTALACIÓN DE 6 LÍNEAS
TEKNISKE DATA FOR ET 6-LINJESYSTEM - TEKNISKE DATA FOR ANLÆG MED 6 LINJER
TEKNISKA DATA FÖR ANLÄGGNING MED 6 LEDNINGAR
ТЕХНИЧЕСКИЕ ДАННЫЕ ДЛЯ СИСТЕМЫ С 6 ЛИНИЯМИ А6 LINEE 线路系统设备技术数据。

N° Prodotti collegabili / Sezione cavo
 No. of products that can be connected / Cable cross section.
 Nombre de Produits reliables / Section câble
 Anzahl der Strahler, die miteinander verbunden werden können / Kabeldurchschnitt
 N° Verbindbare producten/Doorsnee kabel
 N° de productos a conectar/Sección del cable
 Antal produkter der kan tilsluttes / Kabelsnit
 Antall produkter som kan tilkoples / kabelvernsnitt.
 Antal produkter som kan anslutas/kabeltvärsnitt
 Кол-во подсоединяемых приборов / Сечение провода
 可连接的产品编号/电缆横截面

INCASSO - RECESSED APPLICATION TROU D'ENCASTREMENT - EINBAU INBOUW - EMPOTRABLE VEGGMONTERING - INDBYGNING INBYGGNAD ВСТРОЕННЫЙ МОНТАЖ 嵌入	LAMPADA LAMP LAMPE LAMP LAMP LAMPARA LYSKILDE LAMPE LAMPA ЛАМПА 光源 (W)	Sezione Section Section Querschnitt Doorsnee Sección Snit Avsnitt Tvärsnitt Сечение 安装区域 (mm ²)	ALIMENTATORE - BALLAST - BALLAST - VORSCHALTGERÄT VOORSCHAKELAPPARAAT - ALIMENTADOR - STRØMFORSYNINGSENHED BALLAST - STRØMFORSØRJNINGSANORDNING БЛОК ПИТАНИЯ 电源									
			ART. 9908 (9,6W)		ART. 9909 (24W)		ART. 9910 (72W)		ART. 9911 (96W)		ART. 9912 (240W)	
			(N°)	L(m)	(N°)	L(m)	(N°)	L(m)	(N°)	L(m)	(N°)	L(m)
2600-2601-2602-ED70	0,4	2 x 1,5	16	1000	53	1000	174	750	235	550	538	200
2603-2604	0,55	2 x 1,5	12	1000	40	1000	132	850	179	650	410	250
2606 - 2607 - 2608 2620 - 2621 - 2622 B275 - B276 - B277 B294 - B295 - B296 BD71 - BD73 - ED66 ED67	0,75	2 x 1,5	9	1000	29	1000	95	250	128	200	/	/
	2 x 2,5	450						350				
2609 - 2610 - 2623 B278 - B279 - B297 B298	0,7	2 x 1,5	9	1000	31	400	102	100	138	75	/	/
	2 x 2,5	600						180		130		
2611 - 2612 - 2613 B285 - B286 - B287 B304 - B305 - B306 BD72 - BD74 - ED71	0,4	2 x 1,5	16	1000	53	800	174	200	235	200	/	/
	2 x 2,5	1200						400		300		
2614 - 2615 - B288 B289 - B307 - B308	0,4	2 x 1,5	16	1000	53	800	174	600	235	400	/	/
	2 x 2,5	1200						800		600		
2628 - 2629 - 2630 2635 - 2636 - 2637 B313 - B314 - B315 B331 - B332 - B333 ED68 - ED69	1,5	2 x 1,5	/	/	14	800	47	250	64	200	147	100
	2 x 2,5	1000				450		300		150		
	2 x 4	1200				700		500		250		
2631 - 2632 - 2638 2639 - B316 - B317 B334 - B335	1,4	2 x 1,5	/	/	15	400	51	100	69	80	158	40
	2 x 2,5	600				200		140		80		
	2 x 4	1000				300		200		120		
	2 x 1,5	800				250		200		90		
B349 - B350 - B351	0,8	2 x 2,5	8	1000	26	1000	87	450	117	350	269	150
	2 x 4	1200						600		450		200
	2 x 1,5	400						100		80		35
B352 - B353	0,85	2 x 2,5	8	1000	25	600	84	180	114	130	261	60
	2 x 4	1000						280		200		95
	2 x 1,5	800						250		150		100
B367 - B368 - B369	2,45	2 x 2,5	/	/	8	1000	29	400	39	300	89	160
	2 x 4	1200						600		500		250
	2 x 1,5	400						100		90		50
B370 - B371	2,5	2 x 2,5	/	/	8	600	28	200	38	150	87	85
	2 x 4	1000						300		230		130
	2 x 1,5	250						100		150		100
B385 - B386 - B387	4,1	2 x 2,5	/	/	/	/	17	400	23	300	53	180
	2 x 4	600						500		260		
	2 x 1,5	100						90		50		
B388 - B389	4,2	2 x 2,5	/	/	/	/	16	200	22	150	52	90
	2 x 4	300						230		130		
	2 x 1,5	250						100		150		100

DATI TECNICI PER L'IMPIANTO A 6 LINEE - TECHNICAL DATA FOR A 6-LINE SYSTEM
 DONNÉES TECHNIQUES POUR L'INSTALLATION A 6 LIGNES - TECHNISCHE ANGABEN FÜR DIE ANLAGE MIT 6 LEITUNGEN
 TECHNISCHE GEVEENS VOOR DE INSTALLATIE MET 6 LIJNEN - DATOS TÉCNICOS PARA INSTALACIÓN DE 6 LI NEAS
 TEKNISKE DATA FOR ET 6-LINJESYSTEM - TEKNISKE DATA FOR ANLÆG MED 6 LINJER
 TEKNISKA DATA FOR ANLÄGGNING MED 6 LEDNINGAR
 ТЕХНИЧЕСКИЕ ДАННЫЕ ДЛЯ СИСТЕМЫ С 6 ЛИНИЯМИ A6 LINEE 线路系统设备技术数据。

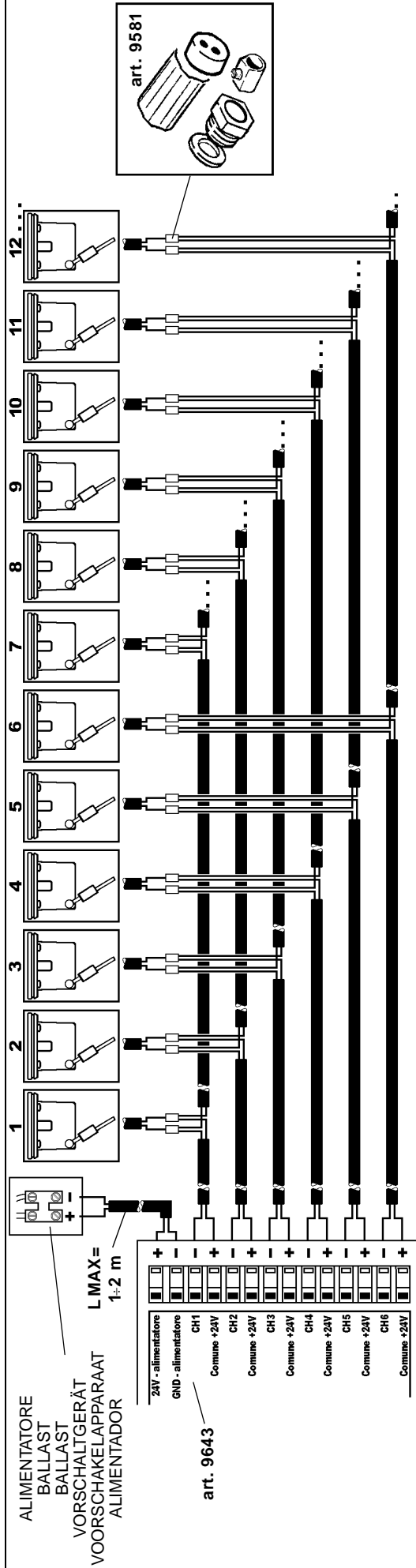

POSIZIONE TUBI CORRUGATI - POSITION OF CORRUGATED PIPES
 POSITIONS DES CONDUITS ANNELÉS - LA GE DER FLEXIBLEN LEERRÖHRE
 POSITIE GEGOLFE BUZEN - POSICI ON TUBOS CORRUGADOS
 PLACERING AF BØLGERØR - POSISJON PÅ KORRUGERTE RØR
 POSITION KORRUGERADE RÖR
 РАСПОЛОЖЕНИЕ ГОФРИРОВАННЫХ ТРУБ
 波纹管位置

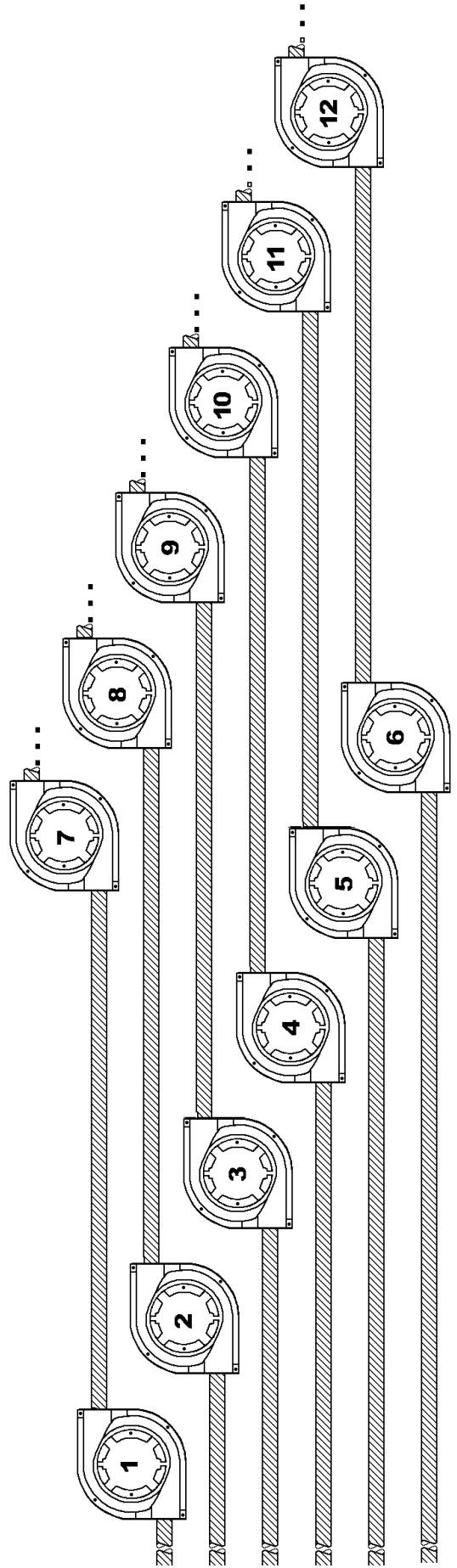

COLOUR EQUALIZER

N° Prodotti collegabili / Sezione cavo
 No. of products that can be connected / Cable cross section.
 Nombre de Produits reliables / Section câble
 Anzahl der Strahler, die miteinander verbunden werden können / Kabeldurchschnitt
 N° Verbindbare producten/Doorsnee kabel
 N° de productos a conectar/Sección del cable
 Antal produkter der kan tilsluttes / Kabelsnit
 Antall produkter som kan tilkoples / kabelverrsnitt.
 Antal produkter som kan anslutas/kabeltvärsnitt
 Кол-во подключаемых приборов / Сечение провода
 可连接的产品编号/电缆横截面

ART.	Sezione Section Section Querschnitt Doorsnee Sección Snit Avsnitt Tvärsnitt ЛАМПА 安装区域 (mm ²)	ALIMENTATORE - BALLAST - BALLAST - VORSCHALTGERÄT VOORSCHAKELAPPARAAT - ALIMENTADOR - STRØMFORSYNINGSENHED BALLAST - STRÖMFÖRSÖRJNINGSANORDNING БЛОК ПИТАНИЯ 电源											
		ART. 9908 (9,6W)		ART. 9909 (24W)		ART. 9910 (72W)		ART. 9911 (96W)		ART. 9912 (240W)			
		N°	L (m)	N°	L (m)	N°	L (m)	N°	L (m)	N°	L (m)		
2633 - 2640 B328 - B346	5,2	1	300	4	100	13	30	17	20	20*	20		
			500		200		50		40		30		
			800		300		80		60		50		
B364	2,6	2	300	8	100	26	30	35	20	82	/		
			500		200		50		40		/		
			800		300		80		60		50		
B382	8	/	/	2	100	8	30	11	20	27	/		
			/		200		50		40		/		
			/		300		80		60		35		
B400	13,2	/	/	1	100	5	30	7	20	16	/		
			/		200		50		40		/		
			/		300		80		60		35		

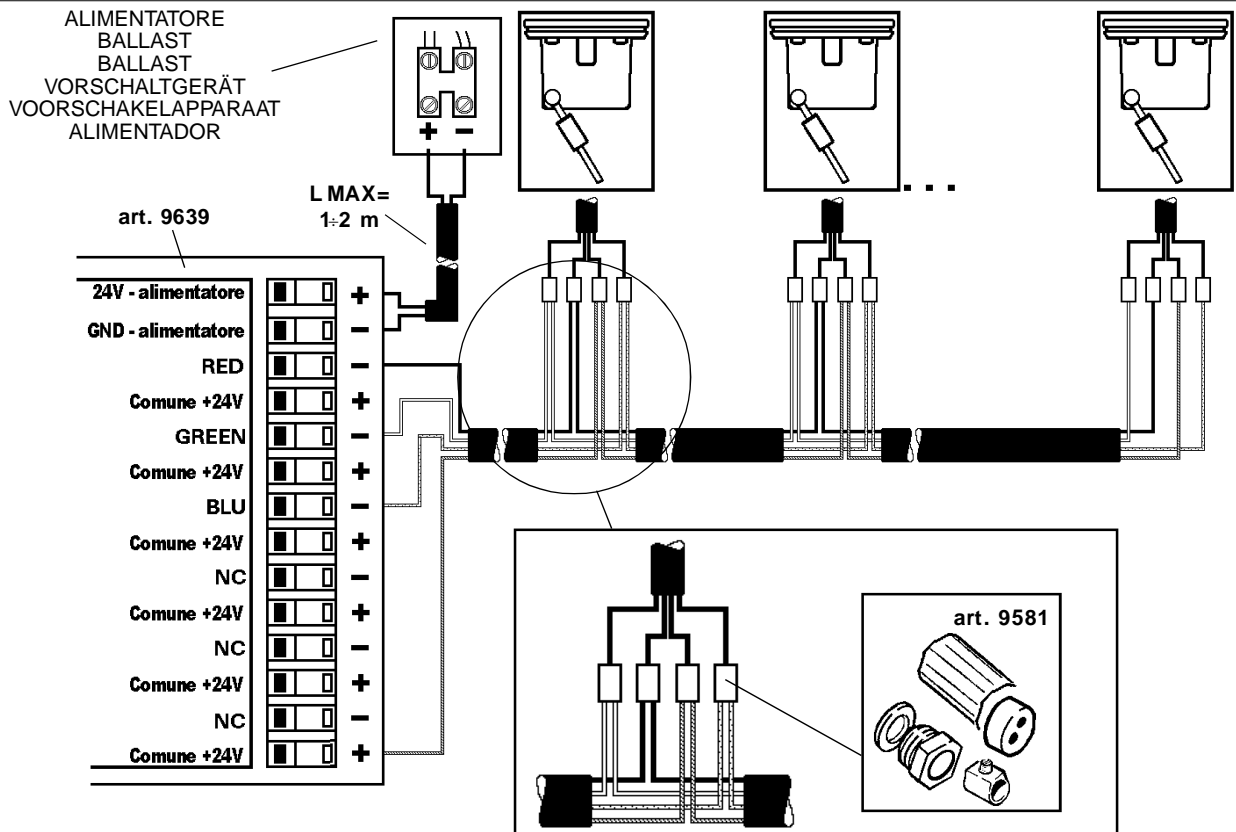

I E' possibile collegare fino a 41 prodotti utilizzando un cavo 4x4mm² per una lunghezza totale di 30m.

GB Up to 41 products may be connected using a 4x4 mm² wire over a total length of 30m.

F Il est possible de raccorder jusqu'à un maximum de 41 produits en utilisant un câble de 4x4 mm², pour une longueur totale de 30 m.

D Es können bis zu 41 Produkte bei Verwendung eines Kabels mit 4x4 mm² und einer Gesamtlänge von 30 m angeschlossen werden.

NL Het is mogelijk op een kabel van 4x4mm² tot aan 41 producten aan te sluiten, voor een totale lengte van 30m.

E Pueden conectarse 41 productos mediante un cable 4x4mm² con una longitud total de 30 m.

DK Der kan tilsluttes op til 41 produkter ved brug af en ledning på 4x4mm² i en samlet længde på 30m.

N Inntil 41 produkter kan tilkoples ved bruk av en 4x4 mm² vaier over en total lengde på 30 m.

S Det går att ansluta upp till 41 produkter genom att använd en kabel på 4x4mm² med en total längd på 30 m.

RUS Можно подключить вплоть до 41 приборов при помощи кабеля 4x4 мм² общей длиной 30 м.

CN 41个产品可能会用总长度超过30m的4x4 mm² 电线进行连接。

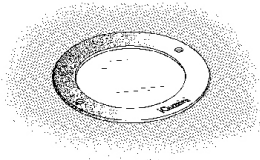

LEDPLUS

تحذير:

لا يمكن ضمان سلامة هذا الجهاز إلا إذا التزمت بهذه التعليمات، يجب حفظها في مكان آمن.

ATTENZIONE:

LA SICUREZZA DELL'APPARECCHIO E' GARANTITA SOLO CON L'USO APPROPRIATO DELLE SEGUENTI ISTRUZIONI; PERTANTO E' NECESSARIO CONSERVARLE.

WARNING:

THE SAFETY OF THIS FIXTURE IS GUARANTEED ONLY IF YOU COMPLY WITH THESE INSTRUCTIONS; REMEMBER TO CONSERVE IN A SAFE PLACE.

ATENCION:

LA SEGURIDAD DEL APARATO SE GARANTIZA SOLO CUMPLIENDO CUIDADOSAMENTE LAS SIGUIENTES INSTRUCCIONES; POR ELLO, ES NECESARIO CONSERVARLAS.

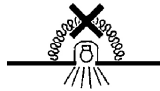
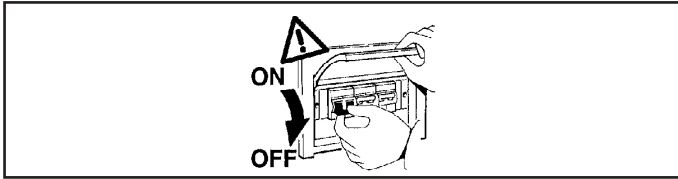

عجب عدم تغطية الجزء المركب، بأي حال من الأحوال، بمواد عازلة أو ما شابه ذلك.

I N.B.: L'apparecchio non deve, in alcuna circostanza, essere coperto con materiale isolante o similare.

GB N.B.: The fixture must not be covered, under any circumstances, by insulating materials or the like.

E NOTA: El aparato no debe ser protegido con material aislante o parecido, por ninguna causa.



ع ترتيب الأنابيب المجددة و/أو الكبلات الكهربائية، يجب مراجعة تصميم الجهاز.

I Per la disposizione dei tubi corrugati e/o dei cavi elettrici, fare riferimento al progetto dell'impianto.

GB See the system project for the arrangement of the corrugated pipes and/or electric cables.

E Para la ubicación de los tubos corrugados y/o de los cables eléctricos, hágase referencia al proyecto de la instalación.

ملاحظة: ملاحظة: أثناء تركيب نظام "LEDPLUS"، يجب التقيد بحرص بالنظم السائدة المتعلقة بالشبكة الكهربائية.

N.B.: DURANTE L'INSTALLAZIONE DEL SISTEMA "LEDPLUS" RISPETTARE SCRUPolosAMENTE LE NORME IMPIANTISTICHE VIGENTI.

N.B.: WHEN INSTALLING THE SYSTEM "LEDPLUS", STRICTLY COMPLY WITH ALL REGULATIONS ON INSTALLATION IN FORCE.

N.B.: DURANTE LA INSTALACIÓN DEL SISTEMA "LEDPLUS" RESPETAR ESCRUPolosAMENTE LAS NORMAS DE INSTALACIÓN VIGENTES.

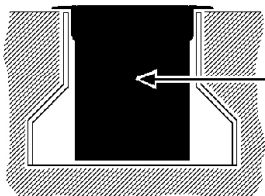

IP68 1m

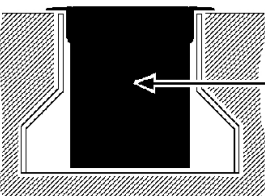

art. B318 - B319 - B320
الاصنف B321 - B322 - B336
IP67 B337 - B338 - B339
B340 - BB45 - BB46
BB49 - BB50

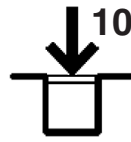

10000/5000N

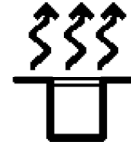

40°C

يستخدم المنتج المصمم للتعامل بحمل ثابت يصل إلى 10000 نيوتن. درجة الحرارة القصوى التي يمكن أن يتحملها المنتج هي 40°C. التركيب مسموح في المناطق المشاة، مسارات الدراجات.

I Gli apparecchi sono stati progettati e collaudati per reggere un carico statico fino a 10000 N; la temperatura massima rilevata sul vetro è di 40°C. L'installazione è ammessa in zone pedonali, piste ciclabili.

GB The fittings were designed and tested to withstand a static load up to 10000 N. The maximum temperature measured on the glass is 40°C. The fittings can be installed on pedestrian areas, cycle lanes.

E Los aparatos han sido diseñados y ensayados para resistir una carga estática de 10000 N; la temperatura máxima medida en el cristal es de 40°C. La instalación está permitida en zonas peatonales, pistas de bicicletas.

عر تنبيه: ينصح القيام بعملية التركيب والصيانة داخل الحجره البصرية أو في أجواء داخلية أو على الأقل في أماكن خالية من الرطوبة و المطر.

I N.B.: Si consiglia di effettuare le operazioni d'installazione o di manutenzione all'interno del vano ottico, in ambienti interni o quanto meno in assenza di umidità o pioggia.

GB N.B.: Installation and maintenance operations must be carried out inside the optical assembly, indoor and in a place with no humidity or rain.

E N.B.: Se recomienda efectuar las operaciones de instalación o mantenimiento dentro del cuerpo óptico, en interiores o por lo menos en ausencia de humedad o lluvia.

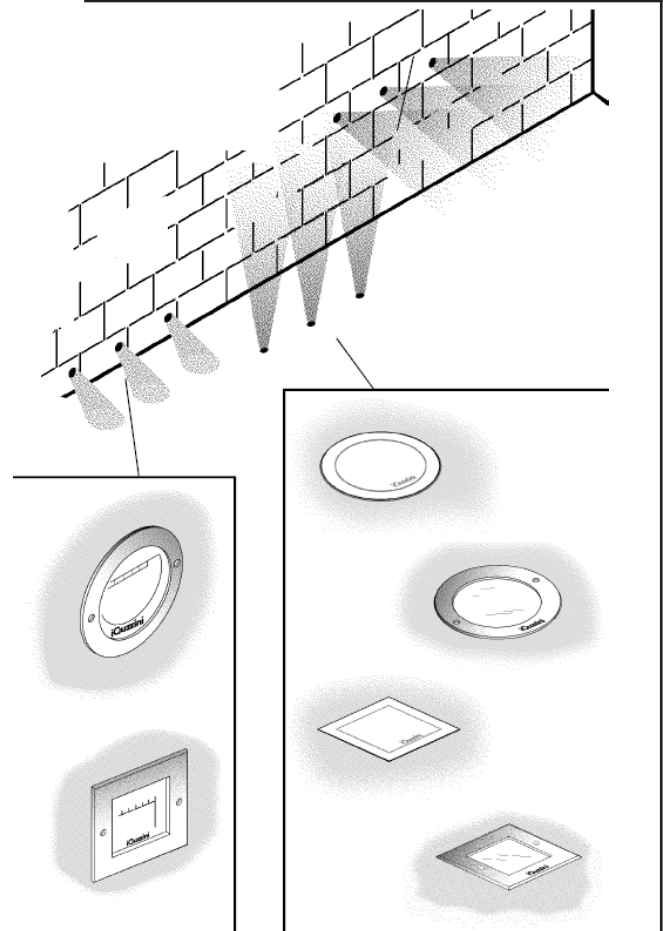
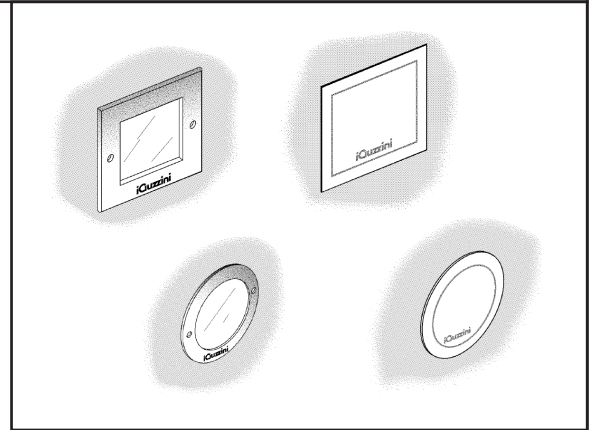

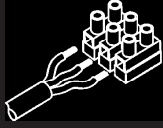

أو وصل المحوّل بالشبكة الكهري بانيّة فقط بعد توصيل المنتجات.

- I Cablare alla rete elettrica il trasformatore solo dopo aver effettuato il collegamento ai prodotti
- GB Wire the transformer to the electrical mains only after the connection to the products has been carried out
- E Cablear el transformador a la red eléctrica sólo después de conectar los productos

بوصى بتوفير الحماية الكافية للكابل، ومنعه من الاتصال المباشر بالأرض.

- I Si consiglia di proteggere adeguatamente il cavo dal contatto diretto con il terreno.
- GB The cable should be suitably protected against direct contact with the ground.
- E Se recomienda proteger adecuadamente el cable del contacto directo con el terreno.

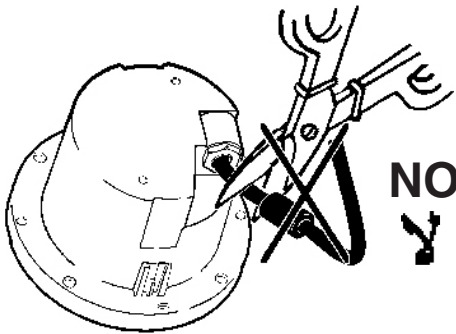
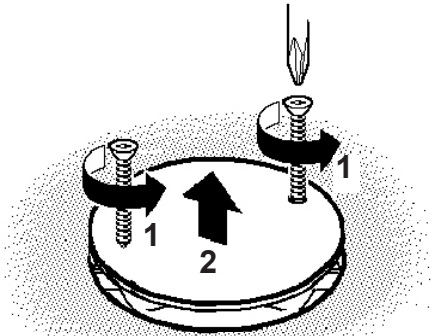

في حال تلف الكبل الخارجي المرص، يجب تغييره من قبل المصنع أو من قبل مركز الخدمة المحوّل أو من قبل أحد أعضاء الطاقم الملائمين والمؤهلين وذلك لتحاكي إلحاق أي خطر.

- I In caso di danneggiamento del cavo flessibile esterno, questo deve essere sostituito dal costruttore, o dal suo servizio di assistenza, o da personale qualificato equivalente, al fine di evitare pericoli.
- GB Should the outer flexible cable be somehow damage, the latter should be replaced by the manufacturer, or by the corresponding service centre, or by an appropriate and qualified member of staff in order to avoid all risk of danger.
- E En caso de daños el cable flexible externo debe substituirse por el fabricante, su servicio de asistencia o personal calificado equivalente para evitar peligros.

مصدر التيار
ALIMENTAZIONE
POWER SUPPLY
CEBADOR

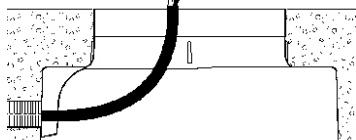
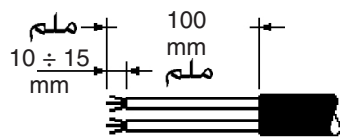

24V \equiv
220/240V \sim

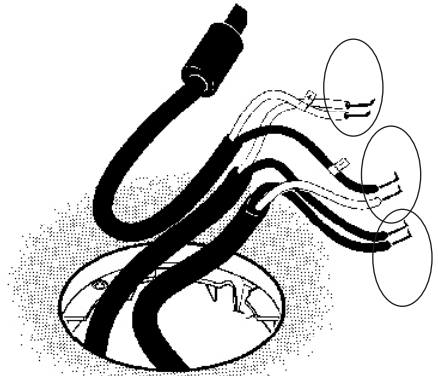
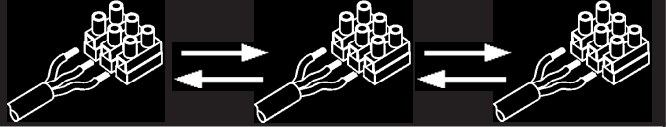
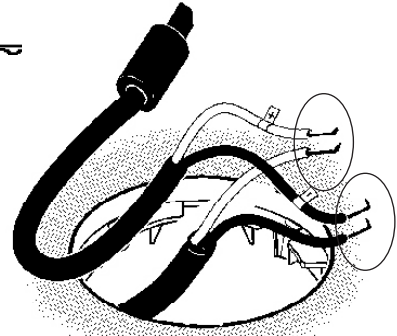

EFFECT EQUALIZER

24V \equiv
220/240V \sim

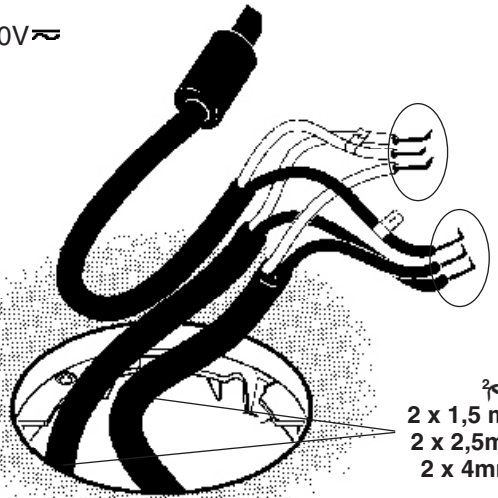

ملم
2 x 1,5 mm²
2 x 2,5mm²
2 x 4mm²

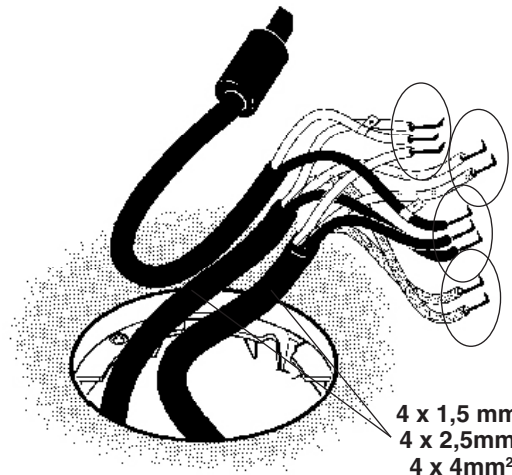

4 x 1,5 mm²
4 x 2,5mm²
4 x 4mm²

COLOUR EQUALIZER

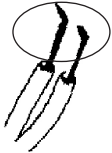
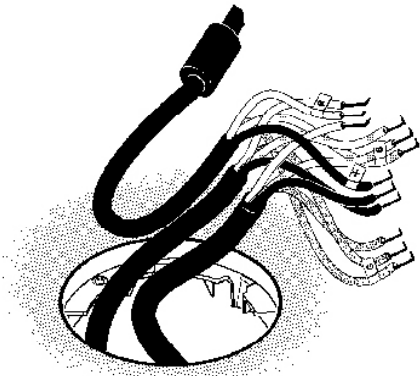

(العربية) جهد منخفض

LOW VOLTAGE == **A** **B** **C**

220/240V ~ **C**

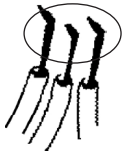

(العربية) جهد منخفض

LOW VOLTAGE == **B** **C**

220/240V ~ **C**

الصف art. 9581

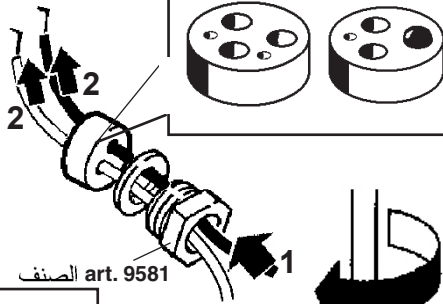
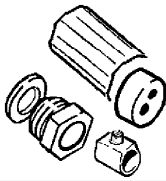

الصف art. 9581

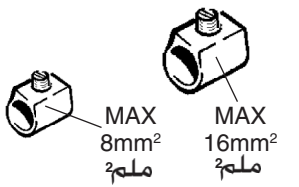

MAX
8mm²
ملم²

MAX
16mm²
ملم²



تنبيه: تحقق يدوياً من مناعة الكيبلات داخل طرف التوصيل.

I N.B.: Verificare manualmente la tenuta dei cavi nel morsetto.

GB N.B.: Manually check the tightness of the cables in the terminal board.

E N.B.: Verificar manualmente la fijación de los cables en el terminal.

A

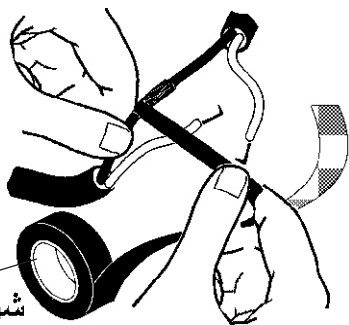

شريط يتكتل بشكل ذاتي

NASTRO AUTOAGGLOMERANTE
SELF-VULCANISING TAPE
CINTA AUTOAGLOMERANTE
(SCOTCH 23 3M)

STAGNARE
WELD
ESTANAR

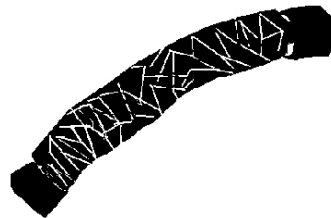
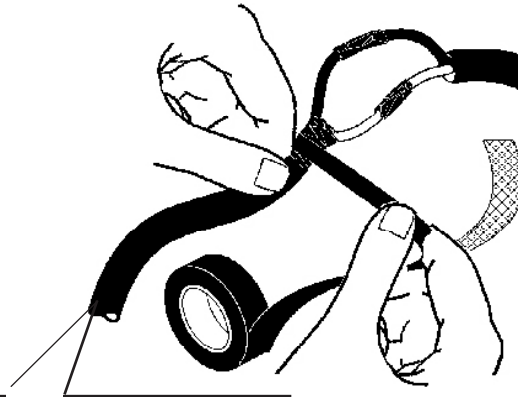
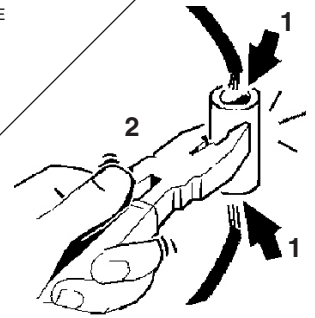

B

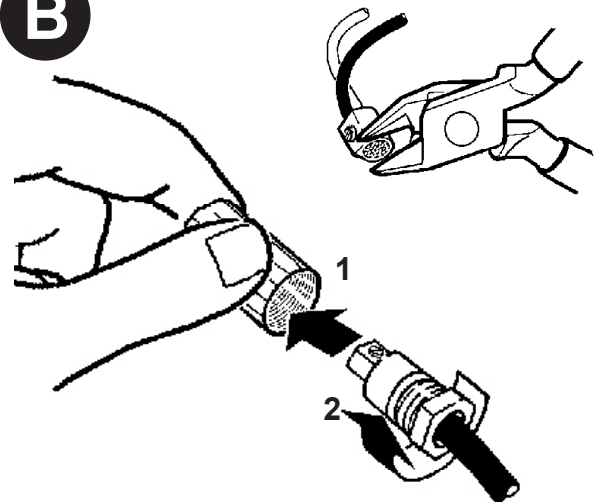

شريط يتكتل بشكل ذاتي

NASTRO AUTOAGGLOMERANTE
SELF-VULCANISING TAPE
CINTA AUTOAGLOMERANTE
(SCOTCH 23 3M)

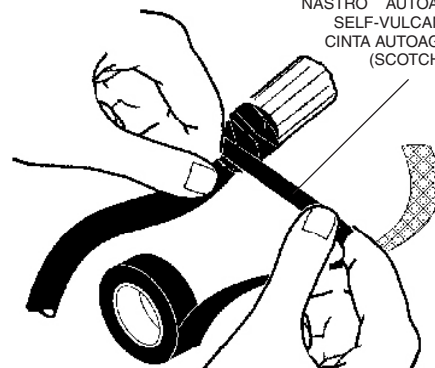

C

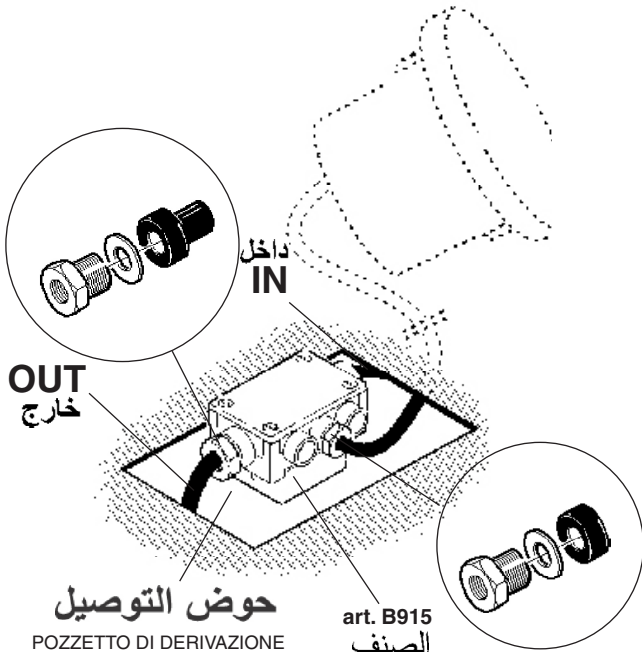

حوض التوصيل
POZZETTO DI DERIVAZIONE
BRANCH POINT
CAJA DE DERIVACIÓN

art. B915
الصنف

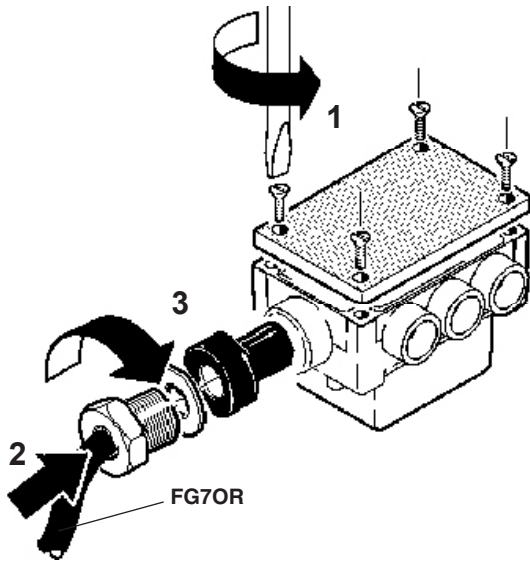

FG7OR

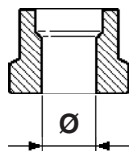
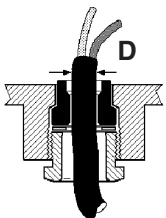
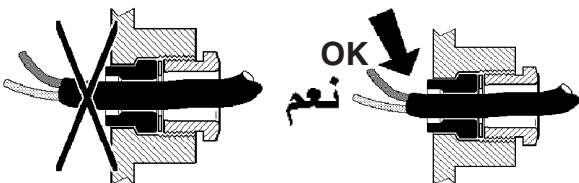

D (mm) ملم	Ø (mm) ملم
8,0 ÷ 10,0	8,5
10,0 ÷ 12,5	11
12,5 ÷ 14,5	13,5
14,5 ÷ 16,0	15,5

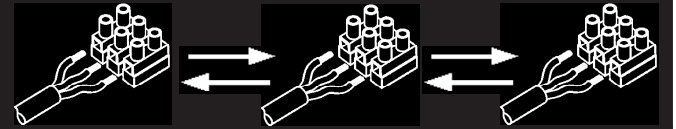
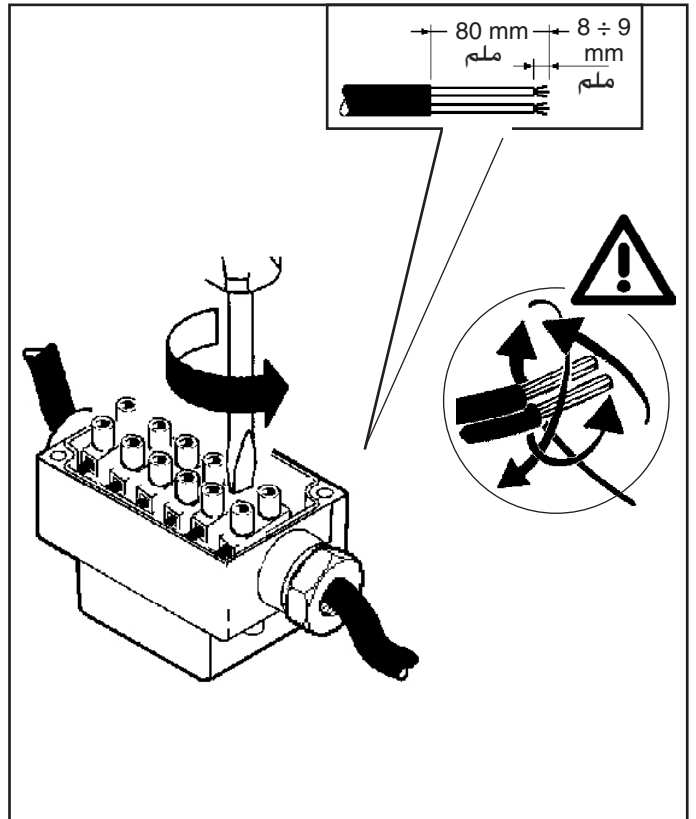

التسليك من خلال
CABLAGGIO PASSANTE
FEEDTHROUGH WIRING
CABLEADO PASANTE

FG7OR
2 x 1,5mm² ملم
ØMAX 16mm ملم

مصدر التيار
ALIMENTAZIONE
POWER SUPPLY
CEBADOR

OUT
خارج

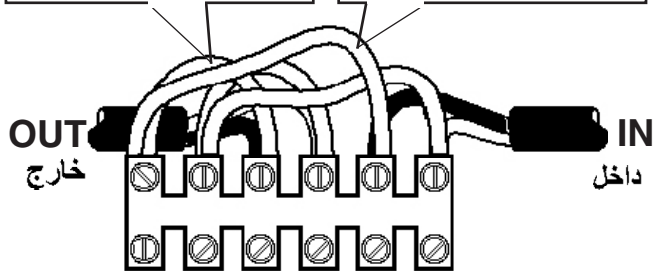
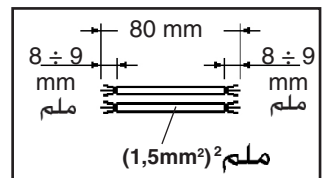
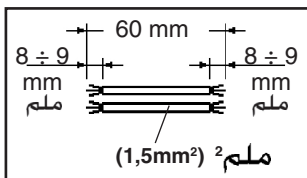
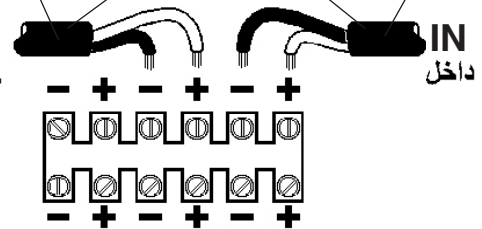

تنبيه: تحقق يدويا من مناعة الكيبلات داخل طرف التوصيل. عر

I N.B.:Verificare manualmente la tenuta dei cavi nel morsetto.

GB N.B.: Manually check the tightness of the cables in the terminal board.

E N.B.:Verificar manualmente la fijación de los cables en el terminal.

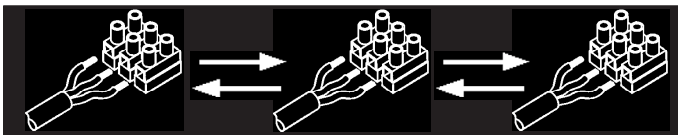

FG7OR
2 x 1,5mm² ملم
ØMAX 16mm ملم

التسليك من خلال
CABLAGGIO PASSANTE
FEEDTHROUGH WIRING
CABLEADO PASANTE

مصدر التيار
ALIMENTAZIONE
POWER SUPPLY
CEBADOR

OUT IN

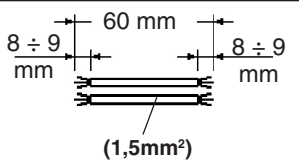
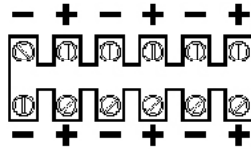

OUT IN

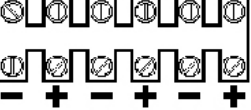

تنبيه: تحقق يدوياً من مناعة الكيلاات داخل طرف التوصيل.

I N.B.: Verificare manualmente la tenuta dei cavi nel morsetto.

GB N.B.: Manually check the tightness of the cables in the terminal board.

E N.B.: Verificar manualmente la fijación de los cables en el terminal.

D

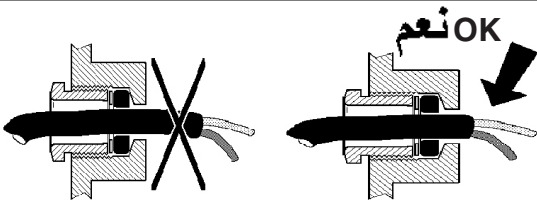
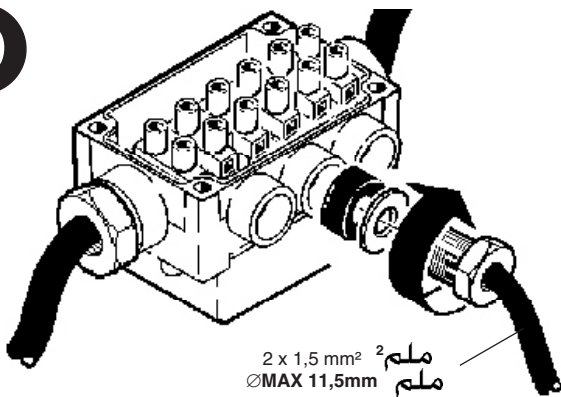

D (mm) ملم	Ø (mm) ملم	Ø	
		3,0 ÷ 5,0	3,9
6,5 ÷ 9,0	8,0		
9,0 ÷ 11,5	10,5		

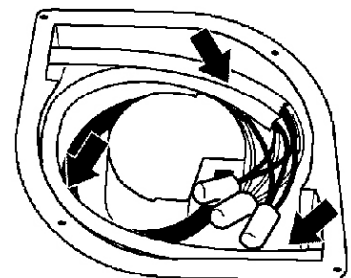
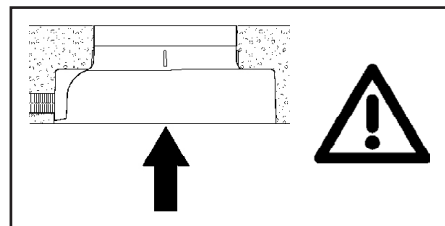
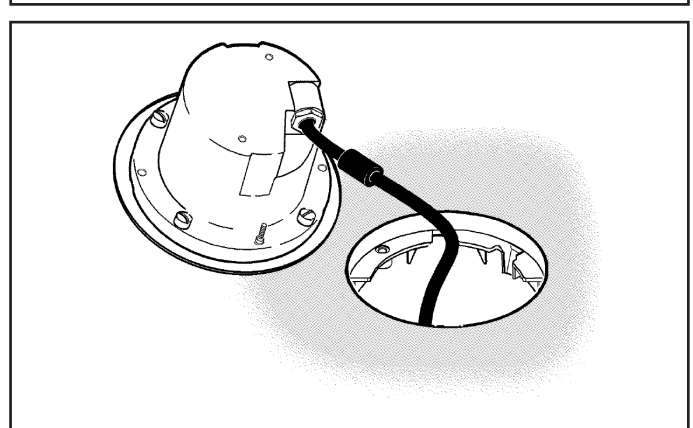
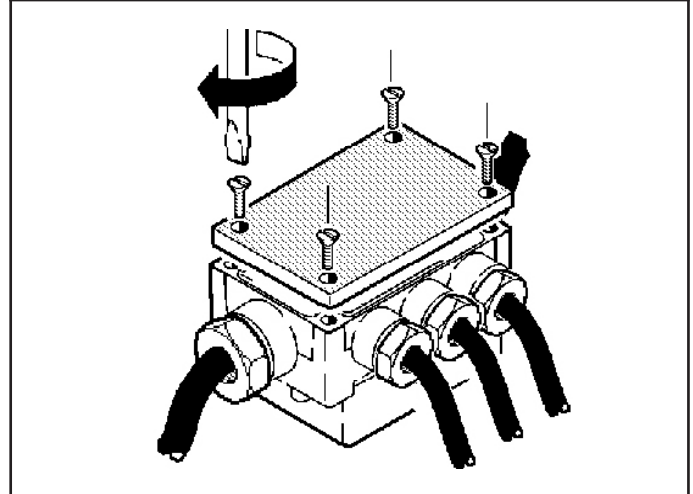
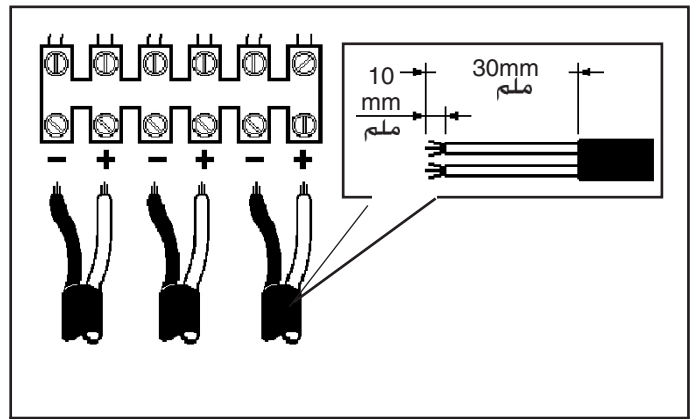

ع
ضع الكيلاات على جوانب الجهاز كما هو مبين في الشكل.

I Disporre i cavi ai lati dell'apparecchio come indicato in figura.

GB Arrange the cables on the sides of the luminaire as indicated in the figure.

E Coloque los cables a los costados del aparato como lo indica la figura.

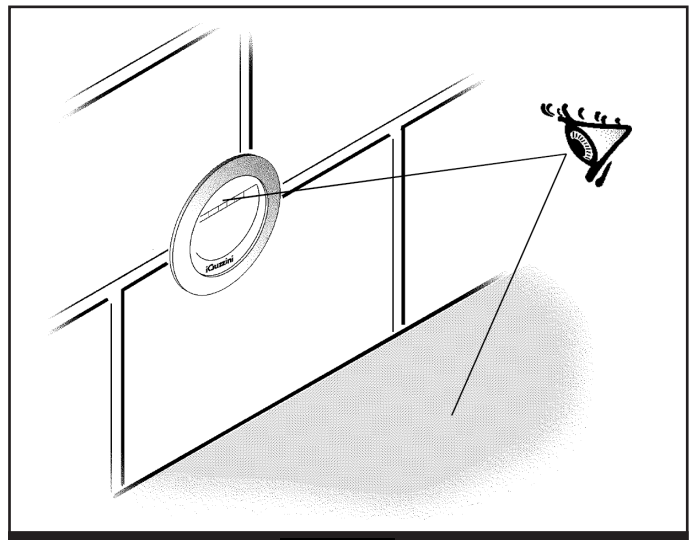
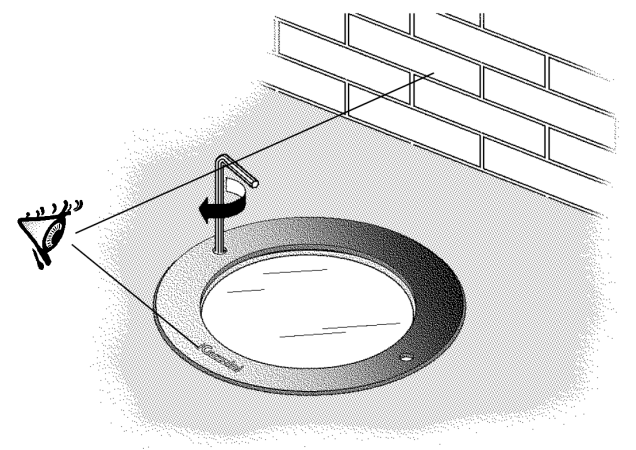
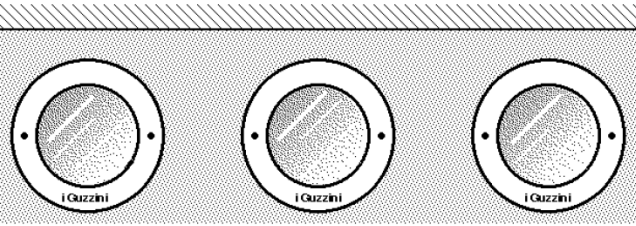
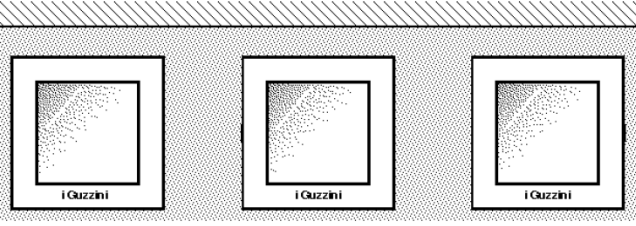
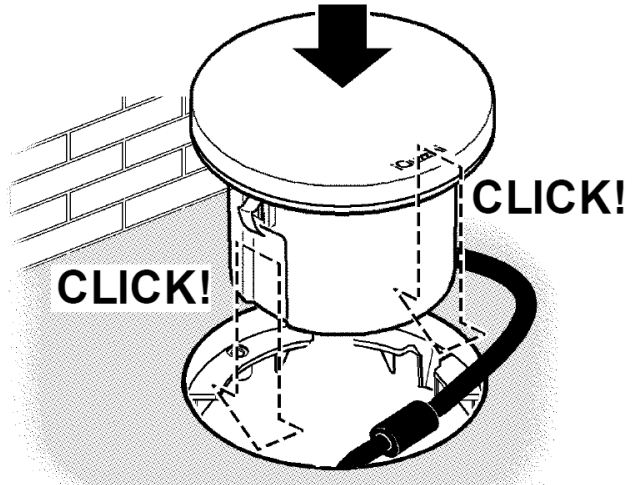
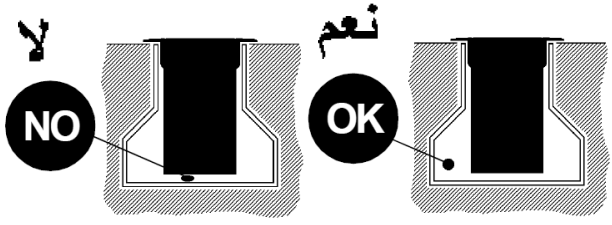

الصف art. B281 - B319
B300 - B337
BB43 - BB44
BB45 - BB46
BB47 - BB48
BB49 - BB50

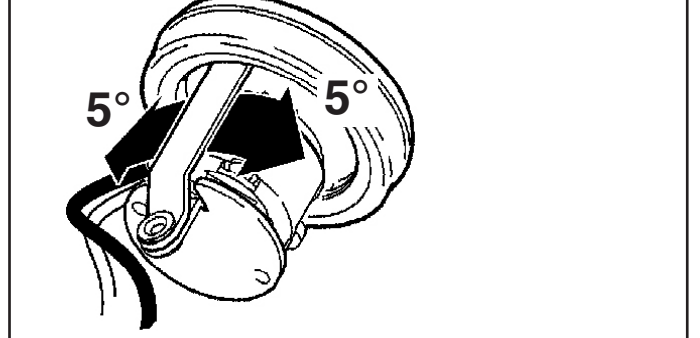
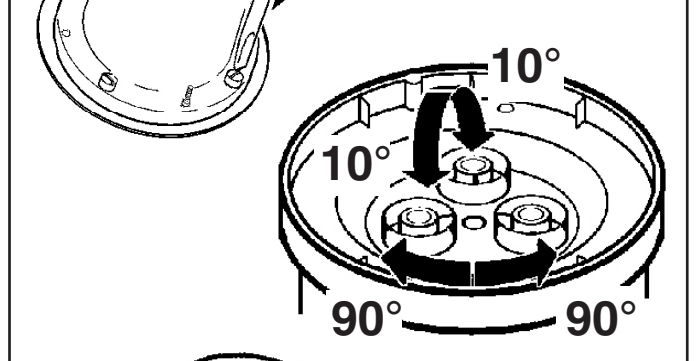

الصف art. 9583

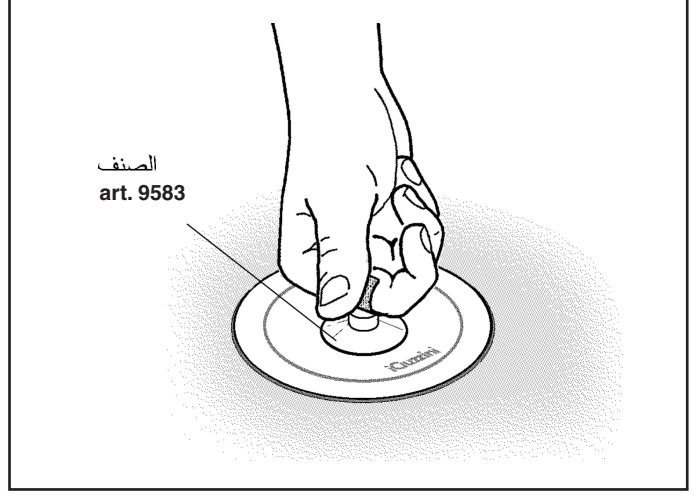

ع
يمكن تركيب مصور توضيحي و فلتر ملون.
I E' possibile installare un pittogramma ed un filtro colorato.
GB A pictogram and coloured filter may be installed.
E Se pueden instalar un pictograma y un filtro cromático.

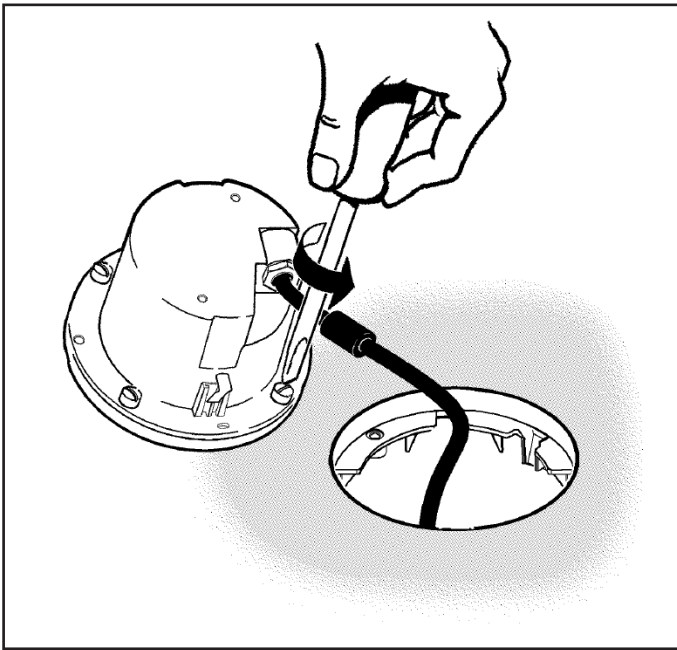

الصف ART.	فلتر الصنف Filtro - Filter - Filtro art.		مصور توضيحي PITTOGRAMMA PICTOGRAM PICTOGRAMA art.				
	ملون Colorato - Coloured - Colorado	ناشر Diffondente - Diffusing - Diffusor					
2606 - 2607 - 2609	9568	-	-	-	-	-	-
2611 - 2612 - 2614 B276 - B278 - B285 B286 - BD72	-	-	-	-	-	-	-
2628 - 2629 - 2631 BD71 - B275	9570 9569	-	9584	9585	9586	9587	9588
B281 - BB43 - BB44	-	9569	-	-	-	-	-
B319 - BB45 - BB46 B328	-	9571	-	-	-	-	-
			9594	9595	9596	9597	9598

الصف ART.	فلتر الصنف Filtro - Filter - Filtro art.		مصور توضيحي PITTOGRAMMA PICTOGRAM PICTOGRAMA art.				
	ملون Colorato - Coloured - Colorado	ناشر Diffondente - Diffusing - Diffusor					
2620 - 2621 - 2623	9572	-	-	-	-	-	-
2635 - 2636 2638 - 2640 BD73 - B294	9574 9573	9572	9589	9590	9591	9592	9593
B295 - B297 - B304 B305 - BD74	-	-	-	-	-	-	-
B300 - BB47 - BB48	-	9573	-	-	-	-	-
B337 - BB49 - BB50 B346	-	9575	-	-	-	-	-
			9608	9609	9610	9611	9612

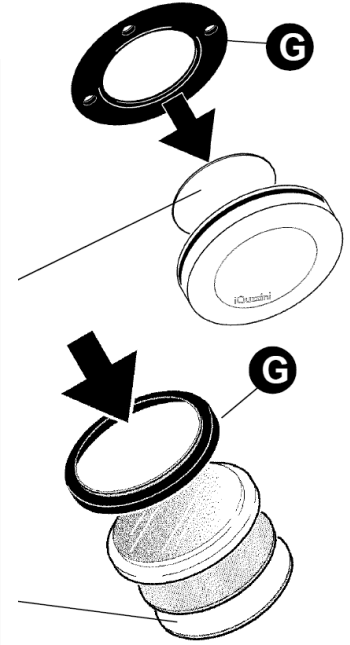

أصفر
GIALLO
YELLOW
AMARILLO

أزرق
CIANO
CYAN
AZULADO

برتقالي
ARANCIO
ORANGE
ORANJE

معتم
OSCURATO
DARKENED
OSCURICIDO

أحمر يميل إلى
الأرجواني
MAGENTA
MAGENTA
MAGENTA

	الصف art. 9584
	الصف art. 9594
	الصف art. 9585 - 9595
	الصف art. 9595
	الصف art. 9586
	الصف art. 9596
	الصف art. 9587 - 9597
	الصف art. 9588
	الصف art. 9598

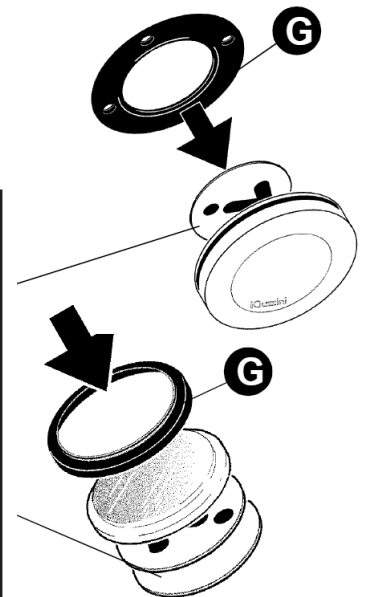

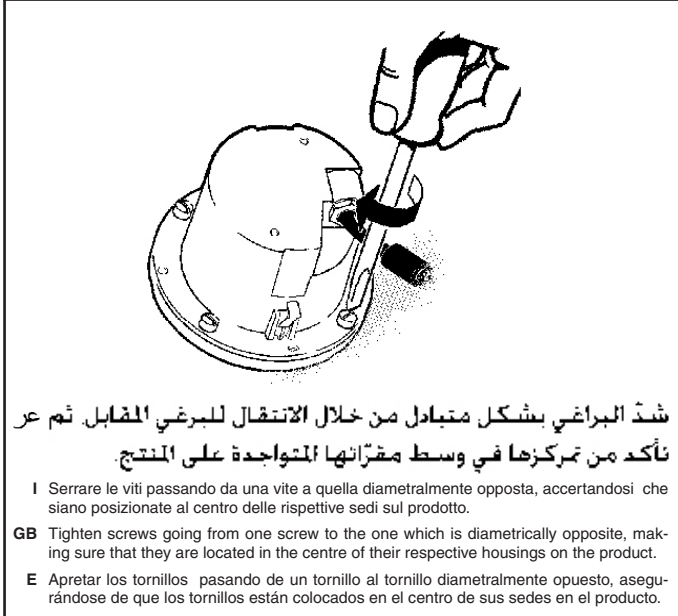
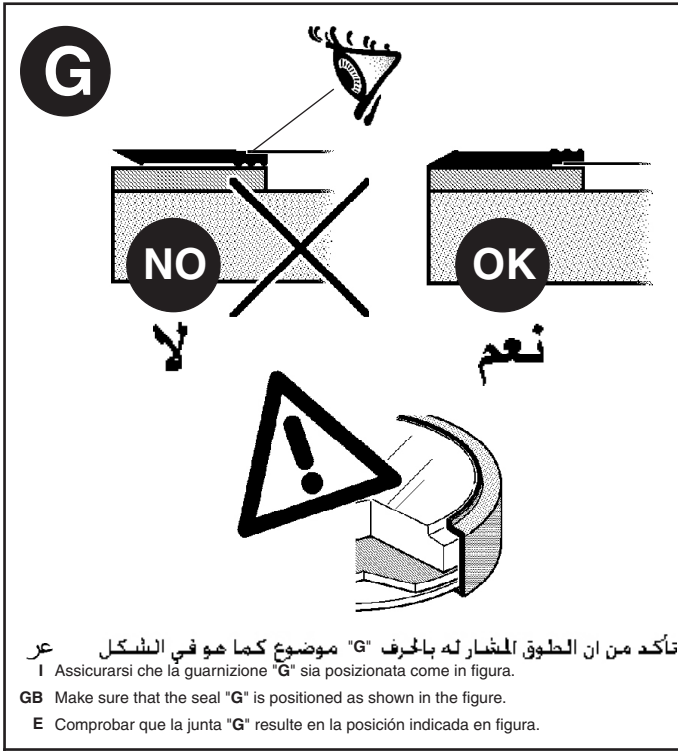

استبدال الضوء LED

SOSTITUZIONE DEL LED
 REPLACING THE LED
 REEMPLAZO DEL LED

تنبيه: لاستبدال الضوء LED اتصل بشركة iGuzzini . عر

I N.B.: Per la sostituzione del LED contattare l'azienda iGuzzini.

GB N.B.: For information on LED replacement please contact iGuzzini.

E NOTA: Para sustituir el LED llame a la empresa iGuzzini.

- I Istruzioni per le operazioni di servizio per l'apparecchio di illuminazione**
GB Instructions on luminaire service operations
F Instructions pour les opérations de service du luminaire
D Wartungsanleitung für die Leuchte
NL Instructies voor de onderhoudsoperaties op de verlichtingsarmatuur
E Instrucciones para las operaciones de servicio del aparato de alumbrado
DK Anvisninger i serviceindgreb på belysningsarmatur
N Anvisninger for betjening av lysapparatet
S Instruktioner för användning av belysningsanordningen
RUS Инструкции по эксплуатации осветительного прибора
CN 照明装置检修操作说明

Sostituire la lampada parzialmente esausta
 Replace the partly exhausted lamp
 Remplacer la lampe partiellement épuisée
 Die teilweise erschöpfte Lampe austauschen
 Vervang de gedeeltelijk lege lamp
 Sustituir la lámpara parzialmente agotada
 Udskift den delvist udtjente pære
 Skifte ut den delvis utbrente lyspæren
 Byt ut den delvis förbrukade lampan
 Замена частично отработанной лампочки
 更换部分老化的灯泡

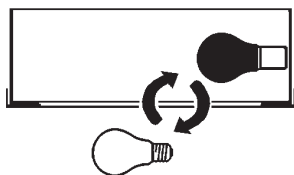

Spegnimento
 Switch it off
 Extinction
 Ausschaltung
 Uitschakeling
 Apagado
 Slukning
 Slukking
 Släckning
 Выключение
 关灯

Interrompere l'alimentazione dell'apparecchio
 Cut the power supply to the luminaire
 Couper l'alimentation du luminaire
 Stromversorgung der Leuchte unterbrechen
 Onderbreek de voeding van het apparaat
 Interrumpir la alimentación del aparato
 Afbryd armaturets strømforsyning
 Avbryte strømtilførselen til apparatet
 Koppla från anordningens strömförsörjning
 Отключить электропитание прибора
 中断装置供电

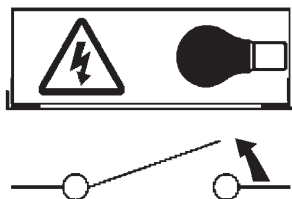

Aprire l'apparecchio
 Open the fixture
 Ouvrir le luminaire
 Das Gerät öffnen
 Open het apparaat
 Abrir el aparato
 Åbn armaturet
 Åpne apparatet
 Öppna anordningen
 Раскрыть прибор
 打开装置

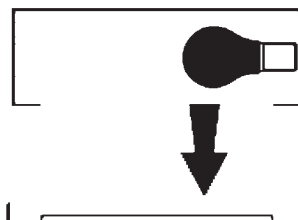

Rimuovere la lampada esausta
 Remove the exhausted lamp
 Retirer la lampe épuisée
 Die alte Lampe entnehmen
 Verwijder de lege lamp
 Quitar la lámpara agotada
 Tag den udtjente pære ud
 Fjerne den utbrente lyspæren
 Ta bort den förbrukade lampan
 Вынуть старую лампочку
 取出老化的灯泡

Portarla in un centro di riciclaggio
 Carry it to a recycling centre
 La porter dans une déchetterie pour son recyclage
 Ordnungsgemäß entsorgen
 Breng de lamp naar een recyclingcentrum
 Llevarla a un centro de reciclaje
 Aflever den på en genbrugsstation
 Lever den til en miljøstasjon
 Lämna in den till en återvinningsanläggning
 Сдать ее в пункт приема утильсырья
 将其送往回收中心

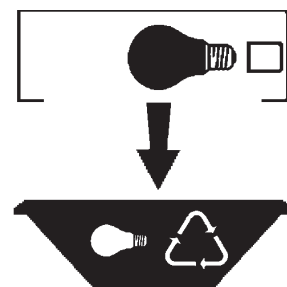

Inserire la nuova lampada
 Introduce the new lamp
 Installer la lampe neuve
 Die neue Lampe einsetzen
 Doe de nieuwe lamp op zijn plek
 Montar la nueva lámpara
 Sæt den nye pære i
 Sette i den nye pæren
 Sätt i den nya lampan
 Вставить новую лампочку
 装入新灯泡

Inserire la nuova lampada nel portalampana
 Fit the new lamp into the socket
 Installer la nouvelle lampe dans le support de lampe
 Die neue Lampe in den Sockel einsetzen
 Doe de nieuwe lamp in de lamphouder
 Montar la nueva lámpara en el portalampana
 Sæt den nye pære i fatningen
 Sette den nye pæren inn i lampeholderen
 Sätt i den nya lampan i lamphållaren
 Вставить новую лампочку в патрон
 将新灯泡插入灯泡架中

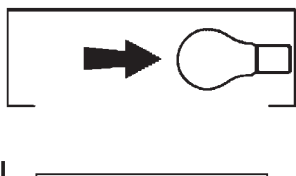

Riposizionare ottica
 Re-place the optic
 Remettre l'optique à sa place
 Die Optik wieder einsetzen
 Doe de optiek weer op zijn plaats
 Volver a montar la óptica
 Sæt den optiske enhed på plads
 Innstille linsen
 Flytta om optiken
 Отрегулировать линзы
 重新定位光头

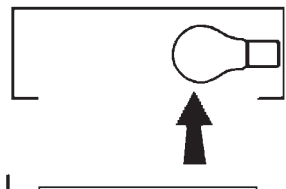

Effettuare prova di funzionamento
 Perform operative test
 Procéder à un essai de fonctionnement
 Eine Funktionsprüfung durchführen
 Controleer de correcte werking
 Hacer una prueba de funcionamiento
 Afprøv funktionen
 Prøve om den fungerer
 Utför funktionstest
 Выполнить проверку исправности работы
 执行功能测试

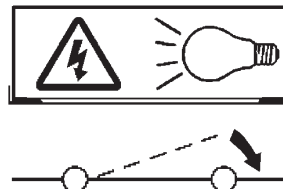

I Istruzioni per la pulizia dell'apparecchio di illuminazione
GB Instructions on luminaire cleaning operations
F Instructions pour le nettoyage du luminaire
D Anweisungen zur Reinigung der Leuchte
NL Instructies voor de reiniging van de verlichtingsarmatuur
E Instrucciones para limpiar el aparato de alumbrado
DK Anvisninger i rengøring af belysningsarmaturet
N Anvisninger for rengjøring av lysapparatet
S Instruktioner för rengöring av belysningsanordningen
RUS Инструкции по чистке осветительного прибора
CN 照明装置清洁说明

Pulire l'apparecchio
Clean the fixture
Nettoyer le luminaire
Das Gerät reinigen
Reinig het apparaat
Limpiar el aparato
Rengør armaturet
Rengjøre apparatet
Rengör anordningen
Чистка прибора
清洁装置

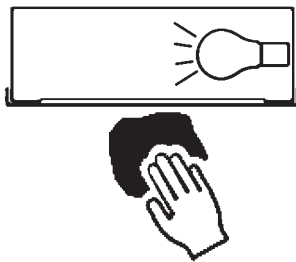

Spegnimento
Switch it off
Extinction
Ausschaltung
Uitschakeling
Apagado
Slukning
Slukking
Släckning
Выключение
关灯

Interrompere l'alimentazione dell'apparecchio
Cut the power supply to the luminaire
Couper l'alimentation du luminaire
Stromversorgung der Leuchte unterbrechen
Onderbreek de voeding van het apparaat
Interrumpir la alimentación del aparato
Afbryd armaturets strømforsyning
Avbryt strømtilførselen til apparatet
Koppla från anordningens strömförsörjning
Отключить электропитание прибора
中断装置供电



Spolverare l'ottica esterna
Remove dust from the external optic
Dépoussiérer l'optique extérieure
Die externe Optik abstauben
Stof de externe optiek af
Quitar el polvo de la óptica exterior
Tør støvet af den udvendige optiske enhed
Fjerne støv fra den eksterne lysenheten
Damma av den yttre optiken
Вытереть пыль с внешней стороны линз
为外侧光头掸尘

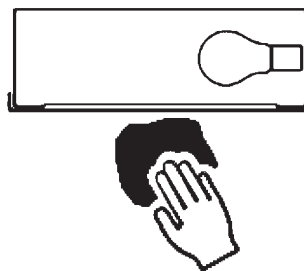

Lavare l'ottica esterna
Wash the external optic
Laver l'optique extérieure
Die externe Optik waschen
Was de externe optiek
Lavar la óptica exterior
Vask den udvendige optiske enhed
Vaske den eksterne lysenheten
Rengör den yttre optiken
Вымыть линзы с внешней стороны
清洁外光头

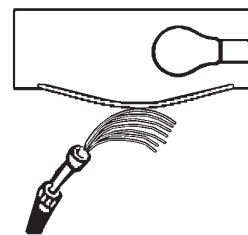

Rimuovere l'ottica
Remove the optic
Retirer l'optique
Die Optik abnehmen
Verwijder de optiek
Quitar la óptica
Tag den optiske enhed af
Fjerne lysenheten
Ta bort optiken
Снять линзы
取下光头

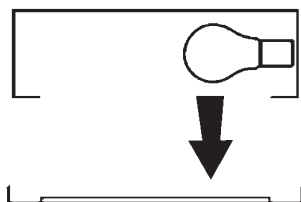

Pulire la parte interna dell'apparecchio di illuminazione
Clean the inside of the fixture
Nettoyer l'intérieur du luminaire
Die Innenseite der Leuchte reinigen
Reinig de binnenzijde van de verlichtingsarmatuur
Limpiar el interior del aparato de alumbrado
Rengør belysningsarmaturets indvendige dele
Rengjøre lysapparatet innvendig
Rengör belysningsanordningen invändigt
Протереть осветительный прибор изнутри
清洁照明装置内部



Riposizionare ottica
Re-place the optic
Remettre l'optique à sa place
Die Optik wieder einsetzen
Doe de optiek weer op zijn plaats
Volver a montar la óptica
Sæt den optiske enhed på plads
Innstille linsen
Flytta om optiken
Отрегулировать линзы
重新定位光头

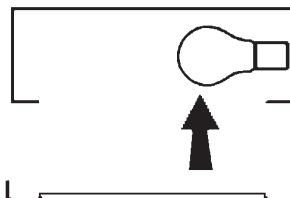

Effettuare prova di funzionamento
Perform operative test
Procéder à un essai de fonctionnement
Eine Funktionsprüfung durchführen
Controleer de correcte werking
Hacer una prueba de funcionamiento
Afprøv funktionen
Prøve om den fungerer
Utför funktionstest
Выполнить проверку исправности работы
执行功能测试

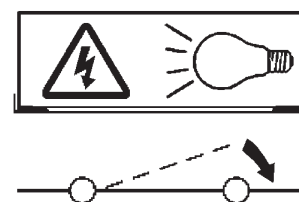

- I** Istruzioni per il fine vita e lo smaltimento dei componenti
GB Instructions on end-of-life and component disposal
F Instructions pour la gestion des composants en fin de vie et leur mise au rebut
D Anweisungen zur Entsorgung der Leuchtenkomponenten
NL Instructies voor het verwijderen van de armatuur en het recyclen van de onderdelen
E Instrucciones para el final de vida y la eliminación los componentes
DK Anvisninger i udtjent armatur og bortskaffelse af komponenter
N Anvisninger for endt levetid og avfallsbehandling av delene
S Instruktioner vid bortskaffning och kassering av komponenter
RUS Инструкции по утилизации прибора и его комплектующих по окончании его срока службы
CN 寿命期结束与零件废弃处置说明

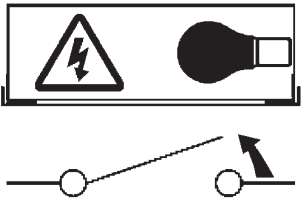
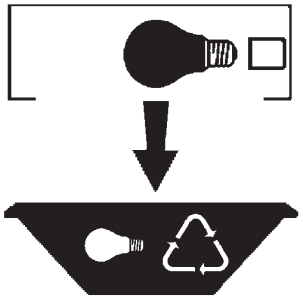
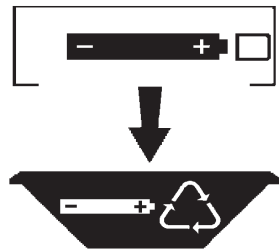
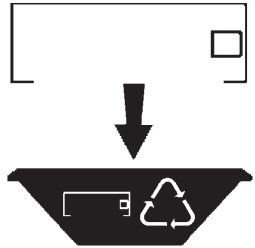
<p>Spegnimento Switch it off Extinction Ausschaltung Uitschakeling Apagado Slukning Slukking Släckning Выключение 关灯</p> <p>Interrompere l'alimentazione dell'apparecchio Cut the power supply to the luminaire Couper l'alimentation du luminaire Stromversorgung der Leuchte unterbrechen Onderbreek de voeding van het apparaat Interrompirla alimentación del aparato Afbryd armaturets strømforsyning Avbryt strømtilførselen til apparatet Koppla från anordningens strömförsörjning Отключить электропитание прибора 中断装置供电</p> 	<p>Rimuovere la/e lampada/e per la dismissione Remove the lamp(s) for decommissioning Retirer la(les) lampe(s) pour sa(leur) mise au rebut Die Lampe/n ordnungsgemäß entsorgen Verwijder de lamp(en) voor het recyclen Quitar la(s) lámpara(s) para el desecho Tag pæren/pærerne ud til bortskaffelse Fjerne lampen/-e som skal kastes Ta bort lampan/-orna för bortskaffningen Вынуть лампочку/и для утилизации прибора 取出需要丢弃的灯泡</p> 	<p>Rimuovere la batteria per la dismissione Remove the battery for decommissioning Retirer la batterie pour sa mise au rebut Die Batterie ordnungsgemäß entsorgen Verwijder de batterij voor het recyclen Quitar la batería para el desecho Tag batteriet ud til bortskaffelse Fjerne batteriet som skal kastes Ta bort batteriet för bortskaffningen Вынуть батарейку для утилизации прибора 取出需要丢弃的电池</p> 	<p>Rimuovere l'apparecchio per la dismissione Remove the fixture for decommissioning Enlever le luminaire pour sa mise au rebut Das Gerät ordnungsgemäß entsorgen Verwijder het apparaat voor het recyclen Quitar el aparato para el desecho Tag armaturet ud til bortskaffelse Fjerne apparatet som skal kastes Ta bort anordningen för bortskaffningen Снять прибор для утилизации 取出需要丢弃的装置</p> 
---	--	--	--

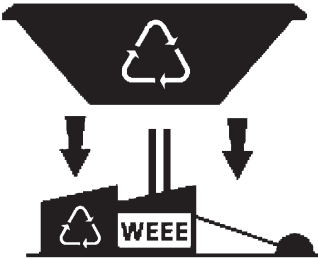
<p>Inviare i materiali ad un centro di raccolta RAEE Send the materials to a WEEE collection centre Envoyer les matériaux dans une déchetterie DEEE Die Materialien in einem WEEE-Zentrum entsorgen Zend de materialen naar een recyclingscentrum voor de AEEA Enviar los materiales a un centro de recogida RAEE Afløver materialerne på et indsamlingscenter for elektronisk udstyr Sende materialene til en miljøstasjon for resirkulering av EE-avfall Skicka materialet till en RAEE uppsamlingscentral Сдать материалы в пункт приема утильсырья 将材料送往电气和电子垃圾回收中心</p> 			
--	--	--	--