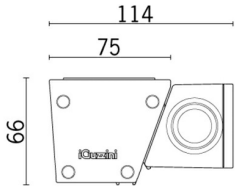

Last information update: May 2018

**Wall-/Ceiling-mounted - 11 Neutral White LEDs - 100-277V ac - L=528mm - Wall Washer Optic****Product code**

BH08

Technical description

Direct light luminaire, designed to use monochrome LED lamps. Ceiling- and wall-mounted. Consists of a body and supports for installation, to be ordered separately. Extruded aluminium body, with die-cast aluminium end caps complete with silicone seals. Coated with liquid acrylic paint with a high level of weather and UV ray resistance. Lateral power supply box made of PPS (polyphenylene sulfide). The top of the optical assembly is closed by a 3 mm thick transparent glass screen, fixed with silicone. Complete with multi-LED plate in Neutral White 4200K. Fitted with a PMMA diffusing filter and optic with plastic (methacrylate) lens for Wall Washer lighting. The lateral box is supplied with a double connector, male/female, with 3-pin quick coupling for pass-through wiring and a closing cap on one side. All external screws used are made of A2 stainless steel. The luminaire technical characteristics conform to EN 60598-1 standards and particular requirements.

Installation

Accessories available for installation: $\pm 90^\circ$ adjustable arms L=138mm (code 5576), arms extendable from 309 to 389mm and adjustable $\pm 90^\circ$ (code 5577), bracket for wall-mounting L=350mm (code BZ10), brackets for mounting on balustrades L297mm (code 5578), bracket for surface- or ceiling-mounting L=350mm (code 5570)

Dimension (mm)

528x75x66

Colour

Grey (15)

Weight (Kg)

1.65

Mounting

wall surface|ceiling surface

Wiring

The product is supplied with electronic control gear, 220÷240Vac, 50/60Hz contained in the luminaire. Available for electrical connection: IP66 3-pin female connector (BZ12), IP66 3-pin male connector + closing cap (BZ13), IP66 3-pin male connector + female connector (BZ14), multi-pole cable units with 3-pin male + female connectors (BZJ0-BZJ1-BZJ2)

Notes

Product complete with LED lamp.

Complies with EN60598-1 and pertinent regulations

**Product configuration: BH08****Product characteristics**

Total lighting output [Lm]: 1125
 Total power [W]: 19.9
 Luminous efficacy [Lm/W]: 56.5
 Life Time: 100,000h - L80 - B10 (Ta 25°C)
 Ambient temperature range: from -20°C to +35°C.

Total luminous flux at or above an angle of 90° [Lm]: 0
 Emergency luminous flux [Lm]: /
 Voltage [V]: -
 Life Time: 66,000h - L80 - B10 (Ta 40°C)
 Number of optical assemblies: 1

Optical assembly Characteristics Type 1

Light Output Ratio (L.O.R.) [%]: 73
 Lamp code: LED
 ZVEI Code: LED
 Nominal power [W]: 18
 Nominal luminous [Lm]: 1540
 Lamp maximum intensity [cd]: /
 Beam angle [°]: /

Number of lamps for optical assembly: 1
 Socket: /
 Ballast losses [W]: 1.9
 Colour temperature [K]: 4000
 CRI: 80
 Wavelength [Nm]: /
 MacAdam Step: 3

Polar

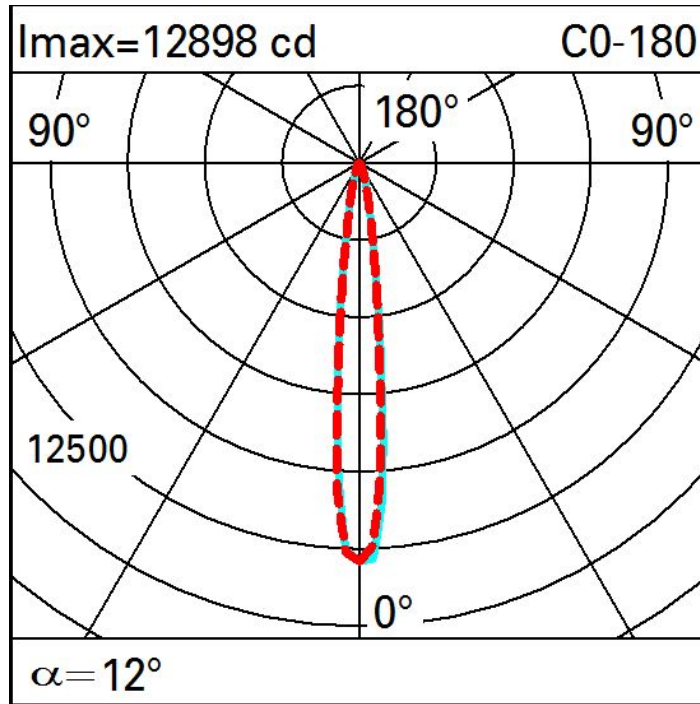

Illuminances

