

# 121265114

Product Sheet

**ares**  
THE OUTDOOR BY FLOS

ARES s.r.l - Socio Unico  
v.le dell'Artigianato n.24 - 20881 Bernareggio - MB (Italy)  
www.aresill.net - flos.outdoor@flos.com

## Andrea

Pole top luminaire for installation on pole or wall (dedicated wall mounting bracket). Configuration: die-cast aluminium structure, EN AB-47100 alloy (low copper content), top cover in pre-galvanised sheet (lower side painted in white) secured to the housing by four extruded aluminium brackets. Acrylic diffuser: clear or opal, 3mm thick. Double layer coating for high resistance to corrosion: the aluminium components are painted with a double coat using powders which are compliant with QUALICOAT standards: a first layer of epoxy powder (with excellent chemical and mechanical resistance) and a second finishing layer of polyester powder (resistant to UV rays and atmospheric agents). The entire painting process of the aluminium fitting starts from components which have been sand-blasted in advance to make the surface more porous and increase the adherence of the paint. Ares effects alkaline and acid washing to clean the surfaces completely, then rinses with demineralised water to remove any residue particles, subsequently a chemical conversion treatment is done to protect against rusting. Protection rating: IP65. In compliance with EN60598-1 standards. Class of insulation: I; LED module: II. Installation: the fixture is equipped with 1000mm cable. Re-lamping through the removal of a disc fitted on the top cover. We recommend the use of a connection system with a protection degree greater than or equal to the protection degree of the luminaire.

### Andrea Power LED / Pole Ø 102mm - Opal (inside) Acrylic Diffuser

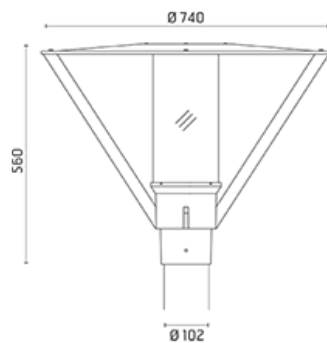

### Product Code Details

# 121265114

Light Source



WARM WHITE 3000K POWER LEDs 44W/220÷240V  
Total power 49W  
LED lm 4013 ÷ OUTPUT lm 3375  
CRI >80  
Integral electronic power supply



IP65

### Available Colors for this Version



6. grey



3. anthracite

### Warnings

#### Pole Top



Pole Top Luminaire



Pre-wired with approx 1000mm of cable.



Protection against impact.  
IK 07 - 02,00 joule

### Light Flux, Placement



## Accessories



Code: 236  
2 way terminal block 3 poles IP68  
(Ø 5,5÷12 mm cable)

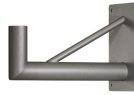

Code: 125  
Wall bracket  
for Ø 60 mm head

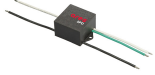

Code: 237  
SPD: (Surge Protection Device) 275Vac  
Maximum discharge current 10KA (8/20µs)  
Maximum operating current 5A  
Suitable for series connection - IP66

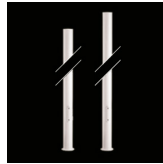

Code: 4140  
Pole with Base and Access Door  
With Terminal Block 4x1,5-16mmq  
Ø102mm  
H 4000mm  
.6 grey  
.3 anthracite

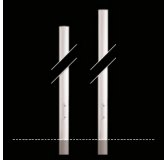

Code: 4145  
In-Ground Pole (+500 mm Root)  
With Access Door With Terminal Block 4x1,5-16mmq  
Ø102mm  
H 4000mm (+500 mm)  
.6 grey  
.3 anthracite

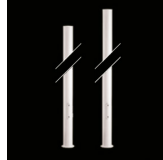

Code: 4150  
Pole with Base and Access Door  
With Terminal Block 4x1,5-16mmq  
Ø102mm  
H 5000mm  
.6 grey  
.3 anthracite

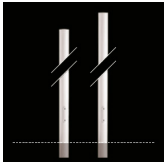

Code: 4155  
In-Ground Pole (+500 mm Root)  
With Access Door With Terminal Block 4x1,5-16mmq  
Ø102mm  
H 5000mm (+500 mm)  
.6 grey  
.3 anthracite



Code: 116  
Base plate and pole fixing bolts  
230 x 230 x H 200 mm