

# VENN 1.0

19-Oct.-2016

## 1.0

LED (38W) | 220-240VAC | 50-60Hz | PCB3-step | phase-cut dim

CE IP20 960° 10.3m P

White texture

149184W\_

Black texture

149184B\_

### LIGHT COLOUR

2700K | >80CRI | 2500lm

2

3000K | >80CRI | 2500lm

4

①

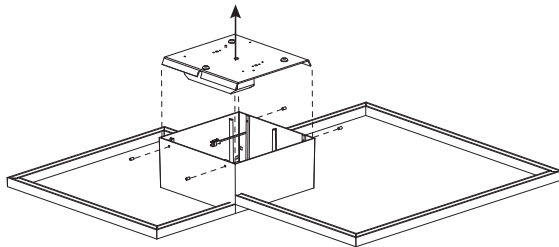

④

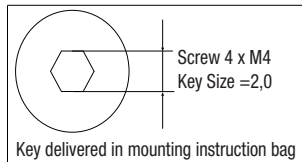
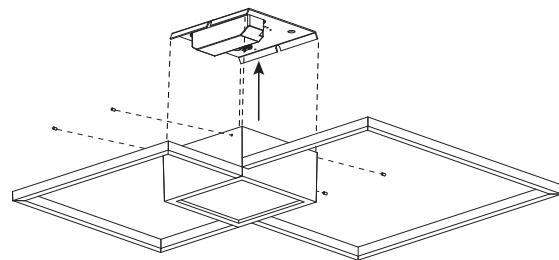

②

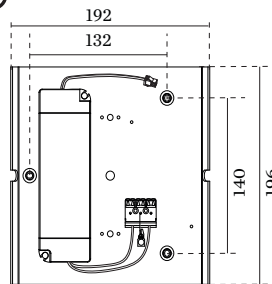

⑤

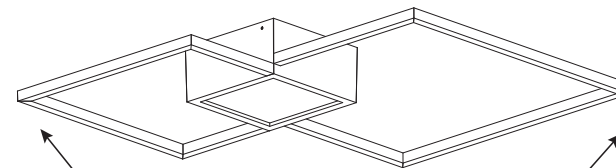

Be careful not to push or pull the arms during installation.

## DIMENSIONS

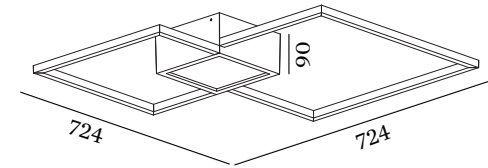

## MOUNTING PLATE FIXATION

- ① Remove the mounting plate.
- ② Fixate the mounting plate to the wall/ceiling with screws.

## POWER CONNECTION

- ③ Connect the terminal block.

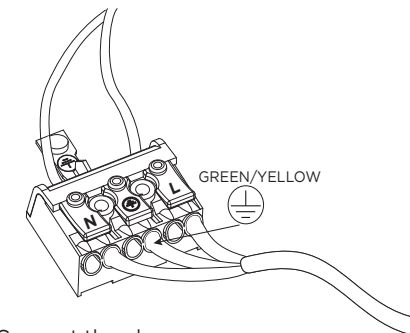

Connect the plugs.

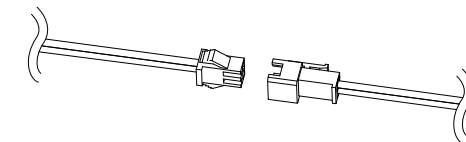

- ④ Fixate the lamp base back to the mounting plate.
- ⑤ Complete

PB19-010-410-00



WEVER & DUCRÉ  
LIGHTING

[www.weverducre.com](http://www.weverducre.com)

Wever & Ducre bvba Kwadestraat 153 bus 2.1 8800 Roeselare

INSTALLATION  
INSTRUCTIONS

PAGE 1/2

# VENN 1.0

**DETAILED MOUNTING INSTRUCTION**  
19-Oct.-2016

**DETAILED DIMENSIONS VENN:**

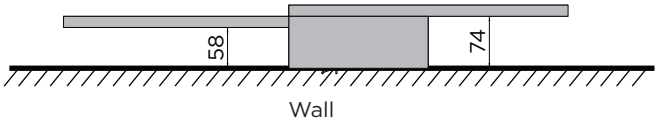
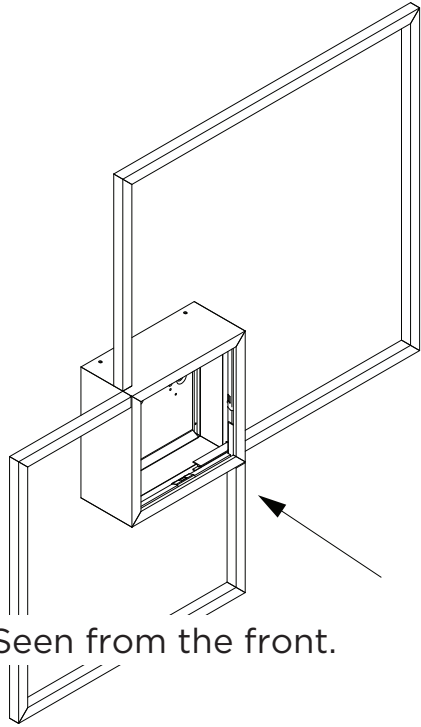
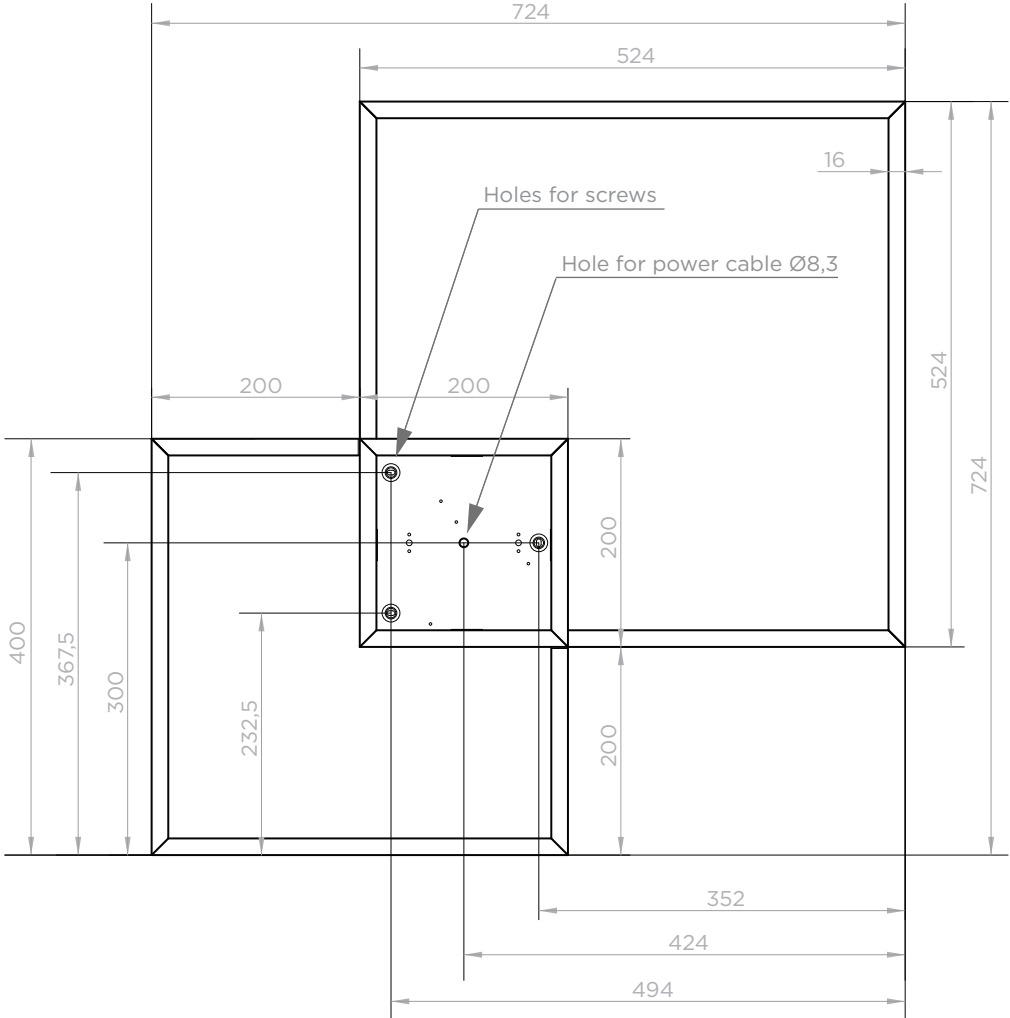

PEB19-010-410-00