

STAKE FOLD

02-11-2015

1.0

LED 8W | 220-240VAC | 50-60Hz | COB 2-step | incl. PS | phase-cut dim

CE IP54 960°C 0.3m 0-90°

3000K | >80CRI | 480lm
dark grey texture

727274D4

OPTIONAL

groundspike
snoot

90013107

90019004

base plate

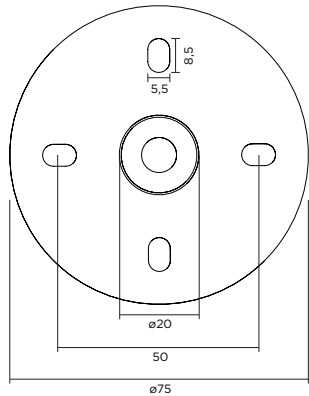

OPTIONAL, (ORDER SEPARATELY)
snoot dimensions



OPTIONAL, (ORDER SEPARATELY)
STAKE FOLD - groundspike dimensions

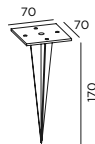

③

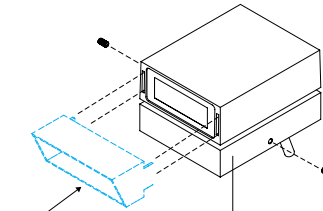

④

* DO NOT COVER BASE (moss, bark, ...).
Permanent moisture & possible chemical
processes from eg. fertilization might lead in
some combinations to a corrosive reaction.

①

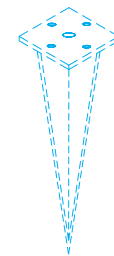
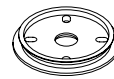

DIMENSIONS

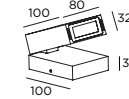

MOUNTING INSTRUCTION

- ① Fix the base plate on the ground by using screws. In case of use with an optional groundspike or on a base*, remove the base plate with the side screws and fix directly on the previewed place on the groundspike.

POWER CONNECTION

- ② Connect the wires with the waterproof connections

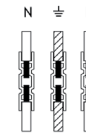

- ③ Attach the STAKE to the base plate with the side screws

- ④ OPTIONAL : click the SNOOT on the STAKE



WEVER & DUCRÉ
LIGHTING

www.weverducre.com

INSTALLATION
INSTRUCTIONS