

PYRAMID

06-07-2015

2.0 LED

LED 7/10W | 350-500mA | COB 3-step | excl. power supply
 CE IP20 960°C 0,9m 35°/35° 355°

white texture

113261W

LIGHT COLOUR

2200K | >80CRI | 315-465lm | 15Vf 1
 2700K | >90CRI | 420-590lm | 18Vf 3
 3000K | >90CRI | 470-640lm | 18Vf 5

ALWAYS USE

for power supplies see our catalogue

2.0 PAR16

PAR16 max. 50W | GU10 | 220-240VAC | 50-60Hz
 CE IP20 960°C 0,9m 35°/35° 355° 50W DO NOT COVER

white texture

113220W

OPTIONAL

for PAR16 lamps see our catalogue

side view

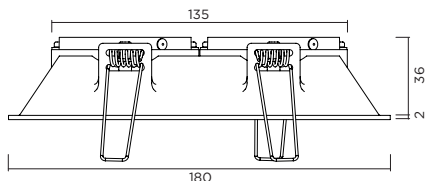

bottom view

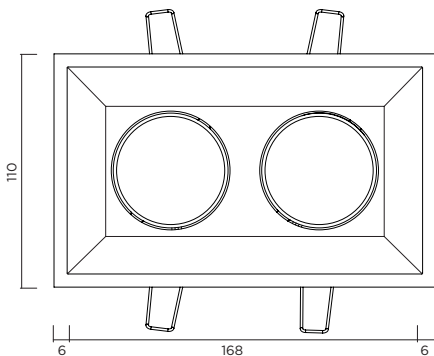

PYRAMID 2.0 LED

①



③

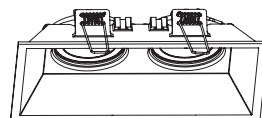

④

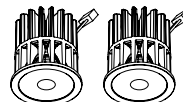

PYRAMID 2.0 PAR16

①



③

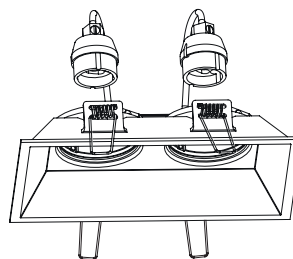

④

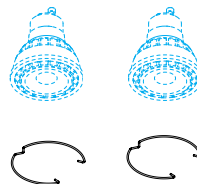

DIMENSIONS

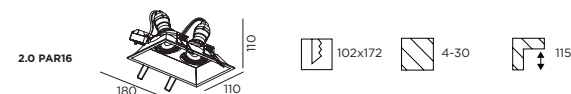
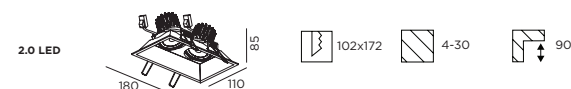

MOUNTING INSTRUCTION

- ① Make a hole in the ceiling according to the prescribed dimensions.

POWER CONNECTION

- ② SERIAL CONNECTION - for LED

Always use **POWER SUPPLY** according to the specifications of the LED-module

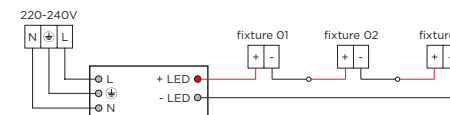

PARALLEL CONNECTION - for PAR16

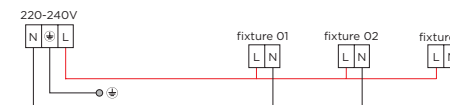

- ③ Insert the fixture in the hole
- ④ Place the LED engines or PAR16 lamps and fix with spring

SAFETY DISTANCE FOR HALOGEN LAMPS

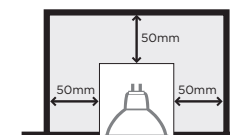

WEVER & DUCRÉ
LIGHTING

www.weverducre.com

INSTALLATION
INSTRUCTIONS