

SQUBE 1.0 ON TRACK

04-Feb.-2017

1.0 LED

LED 6W | 220-240VAC | 50-60Hz | COB 3-step | incl. PS | phase-cut dim

CE IP20 0.3m 36° 90° 355°

white texture	144164W_
black texture	144164B_

LIGHT COLOUR

2700K >80CRI 350lm	2
3000K >80CRI 380lm	4

OPTIONAL

dimmer	
for switch	90019017
for din rail	90019018

more 1-phase track accessories on second page

1.0 PAR16

PAR16 max. 35W | GU10 | 100-240VAC | 50-60Hz

CE IP20 0.9m 36° 90° 355°

white texture	144120W0
black texture	144120B0

OPTIONAL

for PAR16 lamps see our catalogue
more 1-phase track accessories on second page

①

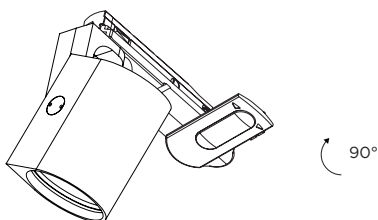

②

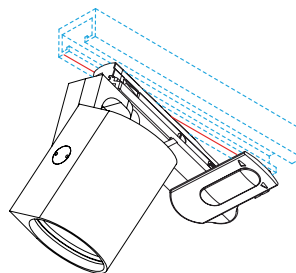

③

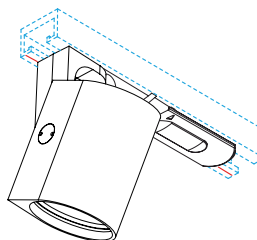

④

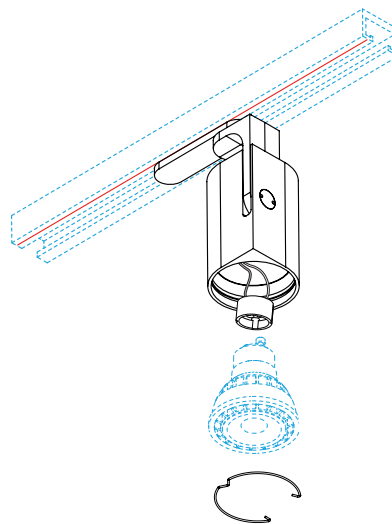

DIMENSIONS

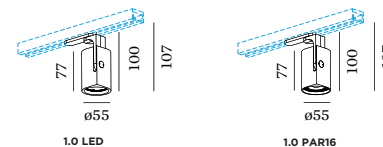

MOUNTING INSTRUCTION

- ① Turn the handle, which is mounted on the fixture, 90°.
- ② Push the fixture into the track. Make sure the ⊕ icon on the inside of the adaptor is faced towards the track side with the small line craved in it. (marked red in the drawing)
- ③ Turn the handle back into the original position.
- ④ For PAR16: mount the lamp into the fixture

The light source of the integrated LED is not replaceable;
When the light source reaches its end of life the whole
luminaire shall be replaced.



Caution, risk of electric shock



WEVER & DUCRÉ
LIGHTING

www.weverducre.com

Wever & Ducre bvba Kwadestraat 153 bus 2.1 8800 Roeselare

INSTALLATION
INSTRUCTIONS

PAGE 1/2

SQUBE ON TRACK

ACCESSORIES

TRACK PROFILE 1m | 1-phase

white
black

90014001
90014007

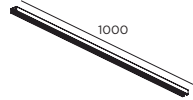

TRACK PROFILE 2m | 1-phase

white
black

90014002
90014008

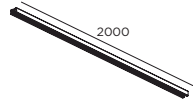

TRACK PROFILE 3m | 1-phase

white
black

90014003
90014009

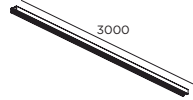

END FEED left

white
black

90014018
90014019



END FEED right

white
black

90014020
90014021

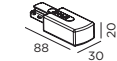

MIDDLE FEED

white
black

90014036
90014037

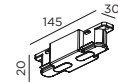

CONNECTOR straight

white
black

90014022
90014023



L-CONNECTOR left

white
black

90014024
90014025

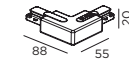

L-CONNECTOR right

white
black

90014026
90014027



END CAP

white
black

90014028
90014029

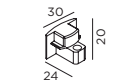

X-connector

white
black

90014049
90014050

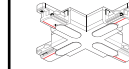

GB38

T-connector

white
black

90014010
90014011

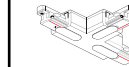

GB40

T-connector

white
black

90014012
90014013

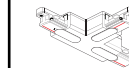

GB39

T-connector

white
black

90014014
90014015

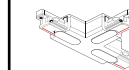

GB36

T-connector

white
black

90014016
90014017

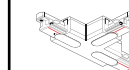

GB37



WEVER & DUCRÉ
LIGHTING

www.weverducre.com

Wever & Ducre bvba Kwadestraat 153 bus 2.1 8800 Roeselare

INSTALLATION
INSTRUCTIONS

PAGE 2/2