

PLANO

23-11-2015

1.0 LED111

LED 13W | 220-240V | 50-60Hz | AC-COB 3-step | phase-cut dim
 CE IP20 960°C 0,9m TE 35°/35° 355°

white texture 118368W_
 silver / grey 118368W_

LIGHT COLOUR

2700K | >80CRI | 640lm 2
 3000K | >80CRI | 680lm 4

OPTIONAL

plaster kit 90017106

1.0 ES111

ES111 max. 75W | GU10 | 220-240V | VAC | 50-60Hz
 CE IP20 960°C 0,9m TE 35°/35° 355° DO NOT COVER

white texture 118320W0
 silver / grey 118320S0

OPTIONAL

for ES111 lamps see our catalogue
 plaster kit 90017106

1.0 QR111

QR111 max. 75W | G53 | 12V | excl. transformer
 CE IP20 960°C 0,9m TE 35°/35° 355° DO NOT COVER

white texture 118330W0
 silver / grey 118330S0

OPTIONAL

for transformers see our catalogue
 plaster kit 90017106

bottom view

side view

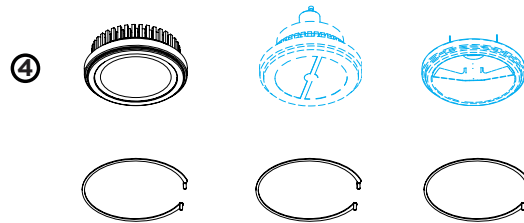
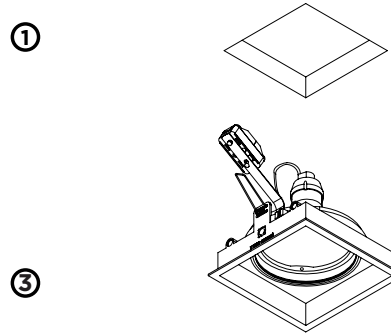
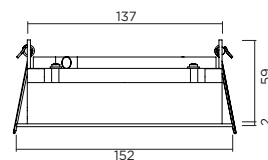
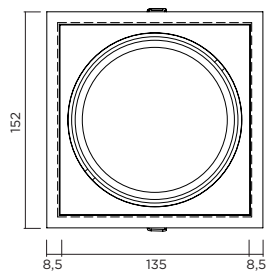

DIMENSIONS

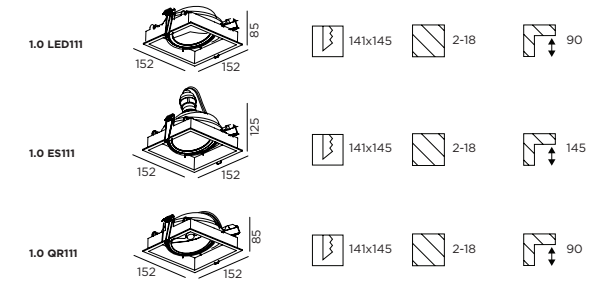

MOUNTING INSTRUCTION

① Make a hole in the ceiling according to the prescribed dimensions.

POWER CONNECTION

② PARALLEL CONNECTION - for LED111 | ES111

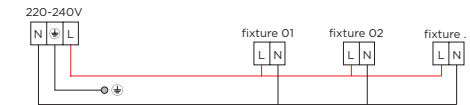

PARALLEL CONNECTION - for QR111

Always use 12V TRANSFORMER

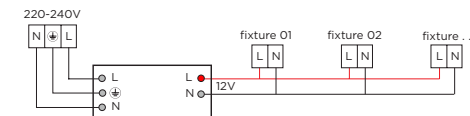

③ Insert the fixture in the hole

④ Place the LED engine, ES111 or QR111 lamps and fix with spring

SAFETY DISTANCE FOR HALOGEN LAMPS

