

MIRBA

24-May-2017

1.0 LED

LED 9W | 220-240VAC | 50-60Hz | PCB 3-step | incl. PS | output selector | phase-cut dim
 CE | IP44 | 0,3m | 3 | 5

white texture 328184W_

LIGHT COLOUR

2700K | >90CRI | 540lm 3
 3000K | >90CRI | 580lm 5

2.0 LED

LED 12W | 220-240VAC | 50-60Hz | PCB 3-step | incl. PS | output selector | phase-cut dim
 CE | IP44 | 0,3m | 3 | 5

white texture 328284W_

LIGHT COLOUR

2700K | >90CRI | 710lm 3
 3000K | >90CRI | 780lm 5

3.0 LED

LED 18W | 220-240VAC | 50-60Hz | PCB 3-step | incl. PS | output selector | phase-cut dim
 CE | IP44 | 0,3m | 3 | 5

white texture 328384W_

LIGHT COLOUR

2700K | >90CRI | 1050lm 3
 3000K | >90CRI | 1150lm 5

Mounting Base:

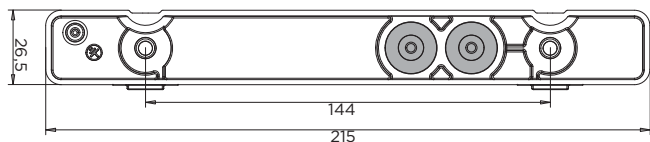

If the installation conditions allow, in order to have a better appearance, we suggest that the side including two socket screws is facing upwards.

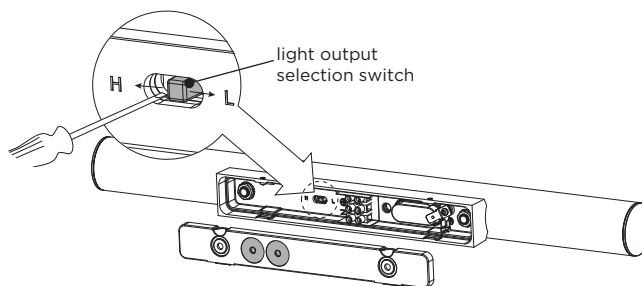
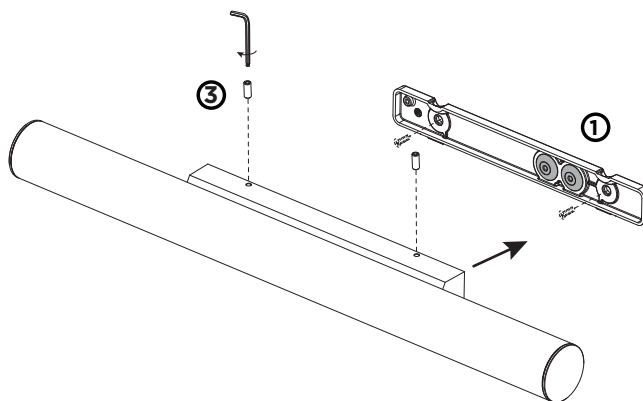

Product must be powered off before switching.

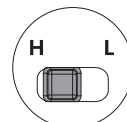

High light output

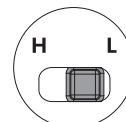

Low light output

DIMENSIONS

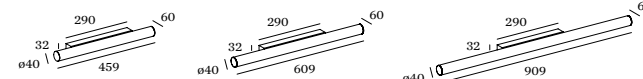

MIRBA 1.0

MIRBA 2.0

MIRBA 3.0

MOUNTING INSTRUCTION

1 Remove the mounting base from the MIRBA and mount it on the wall with screws.

2 POWER CONNECTION

Connect the power supply connection: STANDARD version

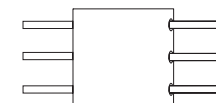

3 Fixate the luminaire on the base with 2 socket screws.

The light source of the integrated LED is not replaceable; When the light source reaches its end of life the whole luminaire should be replaced.



Caution, risk of electric shock

	A	B	C
use appropriate tool			
CABLE			
TYPE	ROUND H05RN-F H07RN8-F H07RN-F	ROUND H05RN-F	ROUND
OUTSIDE Ø	min 6.8mm max 8.9mm	min 5mm max 6.8mm	min 1.5mm max 2.6mm
CONDUCTION SECTION	2or3x 0.75mm ² 2or3x 1.0mm ² 2or3x 1.5mm ²	2or3x 0.75mm ² 2x 1.0mm ²	0.75mm ² 1.5mm ²