

NEW TRIA DLMI ROUND Downlight

matt white, 4000K, 60°

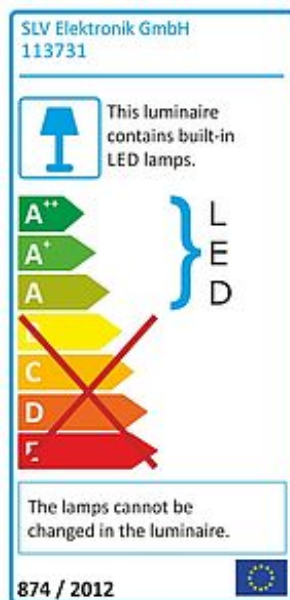

Article number	113731
Catalogue	BIG WHITE 2015, Page 411
Type of lamp	LED lamp
Lamp	Philips Fortimo DLMi Module
Number of light sources	1
Lamp included	Yes
Installation diameter	12.7 cm
Installation depth	19 cm
Tilt range	45 Degree
Rotation range	45 Degree
Height	16.5 cm
Diameter	14.1 cm
Net weight	0.977 kg
Gross weight	1.135 kg
Voltage	230 Volt
Max. wattage	27 Watt
Protection class	I
Beam angle	60 Degree
Material	aluminium
Colour	white
Way of mounting	recessed ceiling mounting
Remark 1	Equipped with the Fortimo LED DLMI module of Philips
Remark 2	Only suitable for ceilings with a maximum thickness of 20 mm
Remark 3	Energy labels in your language are available in the Service Area sub point Download
Average lifespan	25000 Hours
Colour temperature	4000 Kelvin
Colour rendering index	>80
Luminous flux	2000 lm
Suitable for lamps from EEC	A

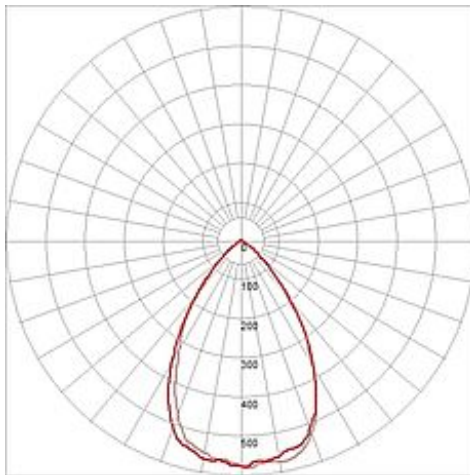
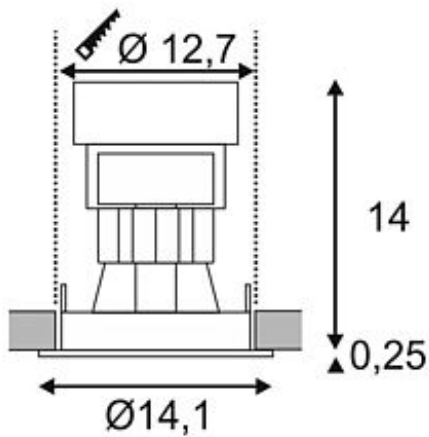

Suitable for lamps up to EEC	A++
Light distribution type 1	direct
Light distribution type 3	rotationally symmetric

The NEW TRIA DLMI downlight is a combination of white or silvergrey aluminum housing and most efficient LED technology from Philips. With a low consumption and its either warm or pure white LED light colour, both the round and square version of the high luminous flux NEW TRIA DLMI downlight is ideal for the exchange of high-intense halogen or incandescent lamps. The DLMI module itself is interchangeable. Thanks to the modular-incorporated LED driver, the NEW TRIA DLMI downlight is ready for direct connection to 230V mains supply. This luminaire contains built-in LED lamps. EEK: A - A++. The lamps cannot be changed in the luminaire.