



















S I M E S

# MINIREEF

ISTRUZIONI DI MONTAGGIO, USO, MANUTENZIONE E SMALTIMENTO  
INSTALLATION, USE AND MAINTENANCE AND WASTE MANAGEMENT INSTRUCTIONS

# MINIREEF

 **CE** IP65 IK10

Tipo Type Art Catégorie Tipo	Lampada Lamp Lampe Lampe Lámpara		
<b>MINIREEF</b>	LED	 	220-240V 
	HIT-TC CRI 20W G8,5	 	220-240V 
	TC-DEL G24q-2	 	230-240V 
<b>MINIREEF            BOLLARD</b>	LED	 	220-240V 
	HIT-TC CRI 20W G8,5	 	220-240V 
	TC-DEL G24q-2	 	230-240V 

MINIREEF

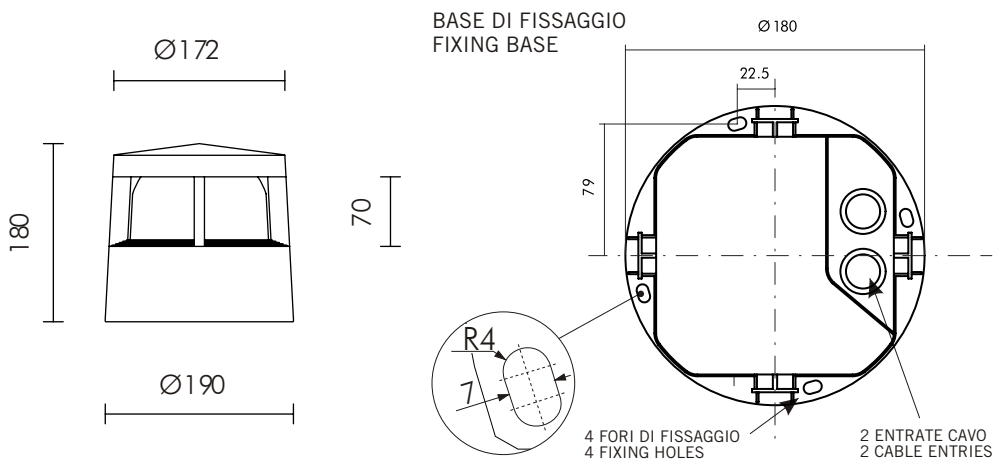

MINIREEF PALETTO  
MINIREEF BOLLARD

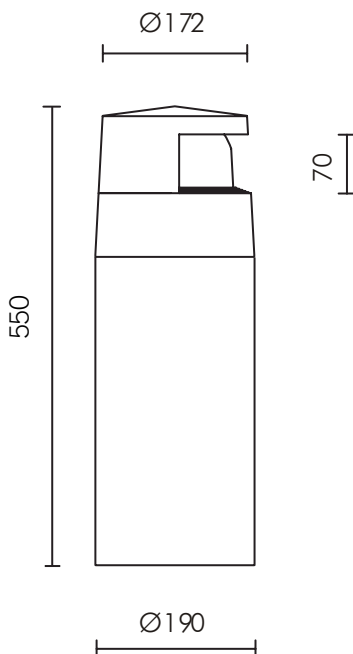

**RACCOMANDAZIONI GENERALI DI INSTALLAZIONE**  
**GENERAL INSTALLATION RECOMMENDATIONS**  
**RECOMMENDATIONS POUR LE MONTAGE**

**S I M E S**

	<p>I Dati tecnici sulla etichetta interna.                  GB Technical data on the internal label.                  D Technische Daten auf der internen Bezeichnung.                  F Données techniques sur l'étiquette interne.                  E Datos técnicos en la etiqueta interna.</p>
--	---

<p>I Gruppo di Rischio 1 (secondo norma EN 62471-2008).                  GB Risk Group 1 (in accordance with EN 62471-2008).                  D Gefährgruppe (nach der Norm EN 62471-2008).                  F Groupe de Risque 1 (selon la norme EN 62471-2008).                  E Grupo de Riesgo 1 (según la norma EN 62471-2008).</p>
--

	<p>I Prodotto idoneo all'uso esterno ed interno.                  GB The article is suitable for outside and inside use.                  D Artikel ist geeignet zur zußerlichen und inneren Anwendung.                  F L'article est adapte pour usage externe et interne.                  E Producto adecuado para uso en exteriores y en interiores.</p>
---	---

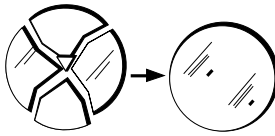
 <p>- Usare solo ricambi originali SIMES.                  - Use only SIMES original spare parts.</p>	<p>I Sostitire lo schermo in caso di danneggiamento prima di riutilizzare l'apparecchio.                  GB In case of diffuser damage change it before to switch on the fitting.                  D Beschädigte Abdeckungen vor erneuter Inbetriebnahme austauschen.                  F En cas de dommages, remplacer le diffuseur avant réutilisation de l'appareil.                  E En caso de difusor dañado cambiarlo antes de encender el aparato.                  SE Vid byte av trasigt glas, kopplas armaturen ur.                  NL Bij glasbreuk dient het glas vervangen te worden vooraleer het armatuur aan te schakelen.                  RU <b>в случае повреждения рассеивателя, не включайте светильник до его замены.</b>                  FI Vioittunut suojalasi on vaihdettava uuteen ennen valaisimen käyttöä.                  P Em caso de avaria do difusor, substituir por outro antes da reutilização da luminária.</p>
---	--

	<p>I Non utilizzare idropulitrici.                  GB Do not use water high pressure cleaners.                  D Hochdruckreiniger benutzung ist verboten.                  F Ne utilisez pas de nettoyeur haute pression sur la luminaire.                  E No utilice limpiadores a presión.</p>
---	--

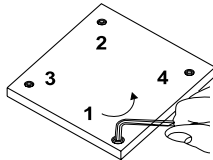
	<p>I Bloccare e sbloccare le viti di chiusura con sequenza alternata.                  GB Lock and unlock the screws following an alternate sequence.                  D Die Verschlusschrauben kreuzweise anziehen bzw. lösen.                  F Bloquer et débloquer les vis de fermeture "en croix", par séquence alternée.                  E Abrir y cerrar los tornillos en secuencia alterna.                  SE Dra åt eller lossa skruvarna genom att följa nummeranvisningarna.                  NL Maak de schroeven steeds allemaal geleidelijk los of vast: schroef dus nooit 1 vjvs helemaal los of vast, maar schroef alle schroeven diagonaal beetje bij beetje los of vast                  RU <b>Закручивайте и раскручивайте болты по очередности, в указанной последовательности.</b>                  FI Kiristä ja avaa ruuvit kivan mukaisessa järjestyksessä.                  P Apertar e desapertar os parafusos de fecho, "em cruz" em sequência alternada.</p>
--	--

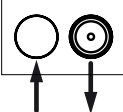
	<p>I Apparecchio predisposto per il collegamento in cascata.                  GB Luminaire designed for "looping-in" (feed through).                  D Die Leuchte ist ausgelegt für Durchgangsverkabelung.                  F Luminaire conçu pour la connexion en cascade.                  E Luminaria preparada para entrada y salida de alimentación.</p>
---	---

**LED**



**Electrostatic Sensitive Device (ESDs)**

- I Prendere precauzioni prima di maneggiare il modulo LED.
- GB Observe precautions for handling the LED module.
- D Bitte beachten Sie die notwendigen Schutzmaßnahmen im Umgang mit der LED- Einheit.
- F Merci d'observer les précautions concernant le traitement du module LED.
- E Tener precaución antes de manipular el módulo LED.
- SE Vidta varsamhet vid hantering av LED-modulerna.
- NL Voorzorgmaatregelen in acht nemen voor de behandeling van de LED module.
- RU Соблюдайте меры предосторожности при обращении со светодиодным модулем
- FI Käsittele led-moduulia varoen.
- P Tenha precauções no manuseamento dos módulos LED.

- I Il modulo LED contenuto in questo apparecchio di illuminazione può essere sostituito esclusivamente dal costruttore. Per un'eventuale sostituzione, si prega contattare il proprio rivenditore.
- GB The LED module contained in this luminaire shall only be replaced by the manufacturer. For further informations, please contact your supplier.
- D Das LED-Modul in dieser Leuchte enthalten darf nur vom Hersteller ersetzt werden. Für weitere Informationen, wenden Sie sich bitte an Ihren Lieferanten.
- F La source lumineuse contenue dans ce appareil peut être échangé seulement par le constructeur. Merci de contacter votre distributeur pour toutes les informations.
- E El módulo LED contenida en esta luminaria sólo se sustituye por el fabricante. Para más información, póngase en contacto con su proveedor.

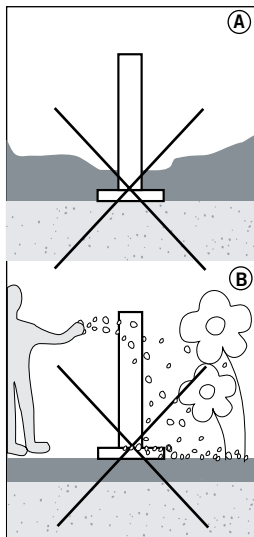

- I Tutte le parti dei prodotti direttamente a contatto con il terreno non devono mai essere ricoperte dal terreno stesso (A) o venire a contatto con sostanze chimiche aggressive (es. fertilizzanti, diserbanti, calce) (B). Pulire periodicamente le parti ricoperte da accumuli di terriccio.
- GB All parts of products in contact with soil (post bases, etc.) must not be covered by soil (A) or must not be in contact with aggressive chemical elements (ex. fertilisers, herbicides, lime) (B). Clean periodically the parts near ground in order to remove possible soil heap on bases or screw heads.
- D Die teile des produkt, die mit boden nebenein ander stehen (wie sockel vom maste), müssen mit boden nie gedeckt sein werden (A) oder dürfen nicht mit dem erdreich oder aggressiven chemischen stoffen (z.b. dünger,unkrautvernichter, kalk) in berührung kommen) (B). Putzen sie periodisch diese teile vom bodenmasse.
- F Toutes les parties des produits qui sont directement en contact avec le terrain (A), (les bases des poteaux), ne doivent jamais être recouvert par le terrain ou venir au contact de substances chimiques agressives (ex : fertilisants, herbicides, chaux) (B). Nettoyer périodiquement les parties recouvertes des terreau.
- S Todas las partes del producto directamente en contacto con el suelo nunca deben ser cubiertas con el mismo suelo (A) o entran en contacto con productos químicos agresivos (por ejemplo, fertilizantes, herbicidas, cal) (B). Limpie periódicamente las partes cubiertas por acumulaciones de tierra.



- I Conservare le istruzioni.
- GB Retain the instructions.
- D Bewahren Sie die Anleitung.
- F Conservez ces instructions.
- E Conserve las instrucciones.

- I** **OGNI MODIFICA DELL'APPARECCHIO E' PROIBITA SENZA PREVIA AUTORIZZAZIONE !!**  
La sicurezza dell'apparecchio è garantita solo rispettando le normative europee del settore elettrico e le istruzioni contenute in questa scatola; pertanto è necessario conservarle. Il rispetto di queste istruzioni è fondamentale per il corretto funzionamento dell'apparecchio e dell'impianto.  
L'installazione deve essere fatta da personale qualificato.  
Non utilizzare lampade di potenza superiore al limite indicato.  
Togliere tensione prima di eseguire le operazioni di manutenzione.
- GB** **ANY MODIFICATION TO THIS FITTING IS FORBIDDEN WITHOUT AUTHORIZATION !!**  
The safety of the fitting is guaranteed only respecting the electrical European norms and the mounting instructions in this box; therefore it is important to conserve them. The respect of these instructions is very important for the fitting and the main line life.  
Installation should be carried out by a suitable qualified person in accordance with good electrical practice and the appropriate national wiring regulations.  
Do not use lamps with higher power than indicated.  
Disconnect main voltage before maintenance operations.
- D** **JEDE UNBEFUGTE ÄNDERUNG AN DIESER LEUCHE IST VERBOTEN !!**  
Die Sicherheit der Leuchte ist nur bei Einhaltung der europäischen Normen und der in dieser Packung enthaltenen Montageanleitungen gewährleistet. Diese sind daher sorgfältig aufzubewahren.  
Diese Anweisungen sind daher unbedingt einzuhalten, um die Funktionsfähigkeit dieser Leuchte und der Beleuchtungsanlage sicherzustellen. Bitte sorgfältig aufbewahren.  
Keine Lampen höherer Leistung als angegeben verwenden.  
Diese Leuchte muss fachmännisch installiert werden.  
Vor Wartungsarbeiten die Leuchte vom Netz trennen.
- F** **TOUTE MODIFICATION DE CET APPAREIL, SANS AUTORISATION, EST INTERDITE !!**  
La sécurité des appareils est garantie uniquement en respectant les normes électriques européennes et les instructions contenues dans l'emballage; aussi est-il nécessaire de les conserver. Le respect de ces instructions est fondamental pour un fonctionnement correct de l'appareil et de l'implantation électrique et doit être suivi scrupuleusement.  
Ne pas utiliser des puissances de lampes supérieures à la limite indiquée.  
L'installation doit être effectuée par des personnes qualifiées.  
Couper l'alimentation avant d'exécuter toute manutention.
- E** **CUALQUIER MODIFICACION DE LOS APARATOS ESTA PROHIBIDA SIN AUTORIZACION !!**  
La seguridad de los aparatos está garantizada solamente respetando las normas eléctricas Europeas y las instrucciones de montaje incluidas en la caja, por lo tanto es importante conservarlas. El respeto de estas instrucciones es fundamental para el correcto funcionamiento del aparato y de la instalación.  
La instalación debe hacerla personal calificado.  
No usar lámparas de potencia superior a la indicada.  
Desconectar la alimentación principal antes de continuar las operaciones de mantenimiento.
- SE** **ALL OMBYGGNAD AV DENNA ARMATUR ÄR FÖRBJUDEN !!**  
Säkerheten av och garantin för armaturen gäller endast om man följer det Europeiska elektriska normerna samt följer den till armaturen bifogade monteringsanvisningen; därför är det viktigt att spara den.  
Installation får endast utföras av behörig person i enlighet med god elektrisk installationssed och nationella installationsregler.  
Använd ej högre effekt än angivet.  
Koppla från armaturen före allt underhåll.
- NL** **ALLE NIET VOORAF TOEGESTANE WIJZIGINGEN AAN DIT TOESTEL ZIJN VERBODEN !!**  
Uitsluitend op basis van de geldende Europeesche normen, en de montagehandleiding in deze doos kunnen wij de veiligheid van de armatuur garanderen. Het is daarvoor van belang deze goed te bewaren. Het respecteren van deze instructies is van belang voor de levensduur van de installatie.  
De installatie moet worden uitgevoerd door een goed gekwalificeerd persoon met de juiste opleiding, en op basis van de nationale regelgeving m.b.t. bedraden.  
Gebruik geen lampen met hogere wattages dan aangegeven.  
Sluit de voedingsspanning af voor onderhoud.
- RU** **ЛЮБЫЕ ИЗМЕНЕНИЯ КОНСТРУКЦИИ СВЕТИЛЬНИКА БЕЗ СОГЛАСОВАНИЯ ЗАПРЕЩАЮТСЯ !!**  
Безопасность светильника гарантирована только при соблюдении электрических норм и правил (ПУЭ), а также инструкции по установке светильника, которая находится в коробке. Поэтому очень важно сохранить их.  
Установка должна осуществляться квалифицированным электриком, имеющим опыт установки подобного оборудования, а также имеющим соответствующий допуск к работам.  
Do not use lamps with higher power than indicated.  
Не используйте источники света мощностью выше обозначенной.

**FI KAIKENLAISET VALAISIMEN MUUTOSTYÖT ILMAN VALMISTAJAN SUOSTUMUSTA OVAT KIELLETTYJÄ !!**

Valaisimen käyttöturvallisuutta ei taata, mikäli valaisinta ei ole asennettu pakkauksessa tulleiden ohjeiden mukaisesti ja käytetty Eurooppalaisten normien mukaisesti; näin ollen on tärkeää säilyttää nämä ohjeet. Valaisimen ja syöttökaapelin käyttöä ajatellen näiden ohjeiden noudattaminen on ensiarvoisen tärkeää.

Asennustyö on suoritettava valtuutetun sähköasentajan toimesta.

Käytä vain arvokilvessä mainittua lampputyyppejä. Valaisimelle tarkoitettua lampputehoa ei saa ylittää.

Katkaise pääjännite huoltotöiden ajaksi.

**P QUALQUER ALTERAÇÃO NESTE APARELHO, SEM AUTORIZAÇÃO, É INTERDITA !!**

A segurança das luminárias é garantida somente se as normas eléctricas Europeias forem respeitadas bem como as instruções de montagem que estão na embalagem. É necessário conservá-las após montagem. A observação das instruções é fundamental para um funcionamento correcto da mesma e a ligação eléctrica deve ser seguida escrupulosamente.

A instalação deve ser executada só por pessoal qualificado.

Não utilizar lâmpadas com potência superior ao limite indicado.

Cortar a alimentação antes de executar a manutenção.

**I RACCOMANDAZIONI GENERALI PER LA MANUTENZIONE**

Per tutti gli apparecchi di illuminazione al di là della classe di appartenenza e del tipo di utilizzo deve essere effettuata a cadenza programmata la manutenzione dell'installazione che deve prevedere almeno le seguenti operazioni:

- Pulire periodicamente gli apparecchi per rimuovere gli accumuli di sporco che si possono depositare sulle griglie e nella testa delle viti seguendo le ulteriori indicazioni riportate sulle istruzioni di montaggio allegate con ogni apparecchio.
- Verificare il serraggio delle viti che fissano le varie parti dell'apparecchio (cornice vetro, vano di ingresso cavo, ecc.).
- Verificare l'integrità di tutti i pressacavi e dei cavi. Verificare il serraggio dei pressacavi.
- Per gli apparecchi in classe I verificare il serraggio del filo di terra all'apparecchio; il morsetto non deve presentare allentamento né ossidazione o danni di qualsiasi tipo. Se il caso serrare a fondo la vite del morsetto.
- Per gli apparecchi in classe II verificare eventuali involucri plastici/isolanti, allo scopo di individuare eventuali danni agli isolamenti.
- Verificare l'integrità e l'elasticità delle guarnizioni, che non devono risultare: Secche, Pizzicate, Interrotte o Danneggiate.
- Verificare l'integrità dello schermo in vetro o plastico. Sostituirlo in caso di rottura o danneggiamento.
- Verificare l'eventuale accumulo di acqua all'interno dell'apparecchio o della cassaforma.

I componenti interni come l'alimentatore, il trasformatore, la morsetteria, ecc. non devono presentare segni consistenti di ruggine o di ossidazione. La presenza di tali segnali indica una possibile penetrazione di acqua all'interno dell'apparecchio. In caso di componenti danneggiati essi vanno sostituiti prima di rimettere in servizio l'apparecchio utilizzando solo ricambi originali.

Si consiglia di effettuare controlli ad ogni sostituzione di lampada o almeno ogni anno scegliendo il periodo più breve in relazione al tipo di impianto.

**GB GENERAL MAINTENANCE RECOMMENDATIONS**

A scheduled maintenance programme must be carried out on the installation and the fittings regardless of their IP rating or application – these must include the following operations:

- clean the fittings from dirt that may be deposited on the protection grills and in the heads of the screws by following the installation instructions attached to each fitting.
- Check that the screws are not loose on the various components of the luminaire (glass frame, cable entry, ...).
- Check each cable gland, and cable for damage and that the cable gland has not come loose.
- For each Isolation Class 1 fitting check that the earth cable has not come loose. The clip must not show signs of oxidation, damage or become loose.
- For class 2 fittings check any eventual plastic / isolating covering in order to verify any damage.
- Check that all the seals are in good condition and that they are not dry, damaged or split.
- Check the glass or plastic screen for damage and replace if required.
- Check for water inside the luminaire's housing and its recessing box.

The internal components such as the ballasts, transformers, washers and screws must not show clear signs of oxidation or rust. Clear traces of rust and oxidation will indicate the presence of water inside the luminaire.

In case of damage the components must be replaced by original components and spare parts before using the fitting.



We also recommend to check the fitting each time the lamp is replaced or at least once a year or within the prescribed maintenance schedule period depending on the type of installation.

# RACCOMANDAZIONI GENERALI DI INSTALLAZIONE GENERAL INSTALLATION RECOMMENDATIONS RECOMMENDATIONS POUR LE MONTAGE

# S I M E S

- I** Nel caso in cui SIMES S.p.A. dia il consenso al reso di apparecchi per il controllo, essi dovranno essere resi senza essere smontati (aprire solo l'anello superiore per la rimozione dalla cassaforma, ove necessario). La scatola di cablaggio NON DEVE essere aperta; il pressacavo non deve essere toccato; deve essere lasciato un pezzo di cavo di alimentazione di 10-20 cm. uscente dalla scatola di cablaggio.
- GB** If SIMES S.p.A. agrees to receive back some fittings for laboratory testing, they MUST NOT BE DISASSEMBLED. If necessary remove only the upper ring, to remove the fitting from its recessing box. The connection box, where the wiring to the terminal block is done, must not be opened and you must cut the cable around 10-20 cm from the connection box.
- D** Wenn SIMES S.p.A. der Rücksendung von Leuchten zwecks Prüfung zustimmt, diese bitte vorher nicht zerlegen. Wenn nötig, nur den oberen Ring entfernen, um die Leuchte aus dem Einbauehäuse zu nehmen. Nicht den Anschlusskasten und die Verschraubung öffnen, das Kabel in 10-20 cm Abstand von der Anschlussdose durchtrennen.
- F** Dans le cas où SIMES S.p.a donne son accord pour un retour d'appareils afin d'en effectuer le contrôle, ceux-ci devront être rendus sans être démontés (ouvrir uniquement la collerette supérieure pour le désolidariser du boîtier d'encastrement, si nécessaire). La boîte de câblage ne DOIT PAS être ouverte, le presse-étoupe ne doit pas être touché ; il faut laisser, à la sortie de la boîte de câblage, un morceau de câble d'alimentation de 10 à 20 cm.
- E** En el caso que SIMES S.p.A. deba analizar algún aparato , deberá entregarse sólo el aro superior. La caja de cableado NO DEBE ABRIRSE; el prensa no debe tocarse y debe dejarse un cable de 10-20cm saliendo de la caja de cableado.

- I** Utilizzare esclusivamente cavi flessibili di diametro adatto in conformità alle norme di installazione nazionali. NON USARE CAVI RIGIDI e/o CON ANIMA METALLICA. Utilizzare esclusivamente cavi di alimentazione in doppia guaina. Non entrare con fili singoli.
- GB** Use only flexible cables of suitable diameter according to the national installation standards. DO NOT USE HARD CABLES OR ARMoured CABLES. Use only supply cables with double case. Do not enter with single cables.
- D** Nur flexible Kabel verwenden gemäß den landesspezifischen Installations-standards.. KEINE STARREN LEITUNGEN VERWENDEN. Brauchen Sie nur die Speisekabel mit doppeltem Mantel. Nicht mit einzelnen Kabeln geben.
- F** Utiliser uniquement des câbles souples selon les normes nationales d'installation. NE PAS UTILISER DE CABLES RIGIDES ou ARMES. Ne pas entrer avec les fils séparés.
- E** Utilizar solo cables flexibles con diámetro adecuado de acuerdo con las normas de instalación nacional. NO ENTRAR CON CABLES RIGIDOS o BLINDADOS. Utilice sólo los cables de alimentación con doble funda. No vaya con cables individuales.
- SE** Använd endast kablar med avsedd diameter enligt den nationella installation standard. ANVÄND EJ HÅRDA ELLER ARMERADE KABLAR. Använd endast nåttsladdar med dubbel mantel. Gå inte med enstaka trådar.
- NL** Gebruik enkel soepele kabels volgens de nationale installatie-norm. GEEN VASTE OF GEWAPENDE SNOEREN GEBRUIKEN ! Gebruik uitsluitend netsnoeren met dubbel omhulsel. Ga niet met enkele draden.
- RU** Используйте только гибкие кабели в соответствии с принятыми нормами. **Ни в коем случае не используйте жесткие или армированные кабели** Используйте только шнуры питания с двойной оболочкой. Не ходи с отдельных проводов.
- FI** Käytä vain liitoskaapelia joustava kansallisen asennusstandardi. ÄLÄ KÄYTÄ JÄYKKÄÄ TAI ARMEERATTUA KAAPELIA ! Käytä vain virtajohdot kaksinkertainen tuppi. Älä mene lankaa.
- P** Utilizar sempre cabos flexíveis de diâmetro adequado de acordo com as normas nacionais de instalação. NUNCA UTILIZAR CABOS RÍGIDOS OU ARMADOS. Utilize apenas os cabos de alimentação com bainha dupla. Não vá com fios individuais

MINIREEF		min 2x1mm <sup>2</sup> max 2x2,5mm <sup>2</sup>	
----------	---	--	--



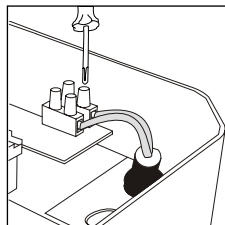
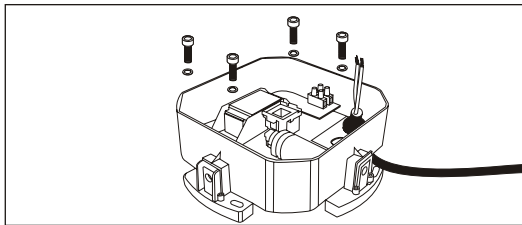
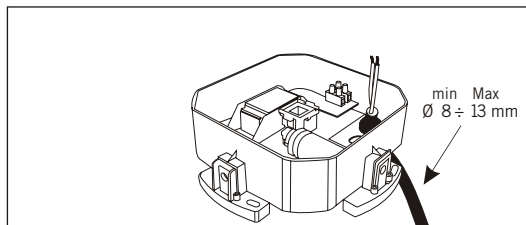
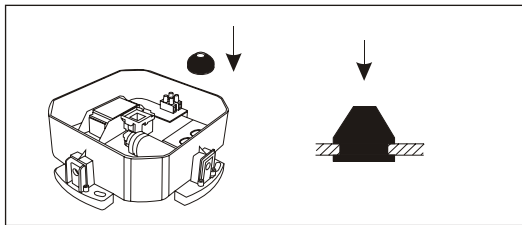
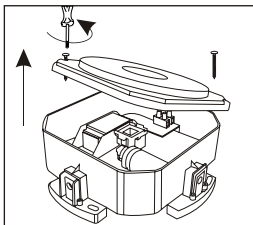
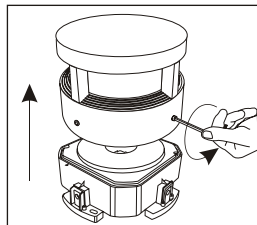

**(L)** → **L**

Linea / Life / Leitung  
 Ligne / Linea / Fas  
 Fase / Фаза / Vaihe  
 Linha

Marrone / Brown / Braun  
 Brun / Marrón / Brun  
 Bruin / коричневый / Ruskea  
 Marrom

**(N)** → **N**

Neutro / Neutral / Null  
 Neutre / Neutro / Nolla  
 Nul / Ноль / Nolla  
 Neutro

Blu / Blue / Blau  
 Bleu / Azul / Blå  
 Blauw / синий / Sininen  
 Azul

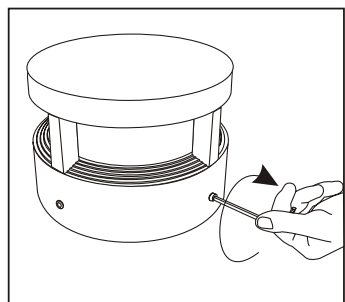
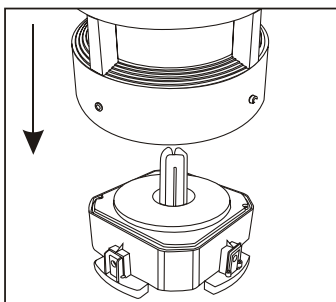
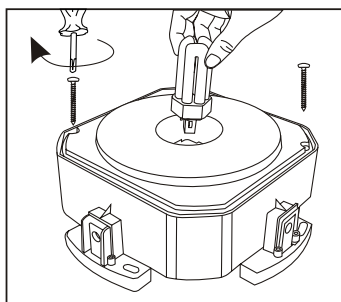

VERSIONE A LED  
LED VERSION

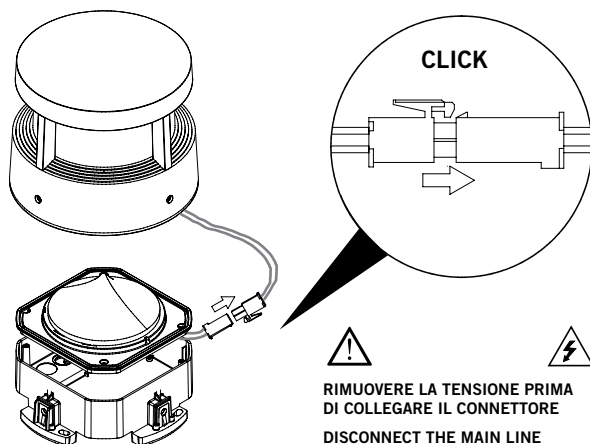

⚠ ⚡

RIMUOVERE LA TENSIONE PRIMA  
DI COLLEGARE IL CONNETTORE  
DISCONNECT THE MAIN LINE  
BEFORE WIRING THE CONNECTOR  
COUPER LA TENSION AVANT DE  
BRANCHER LE CONNEXEUR

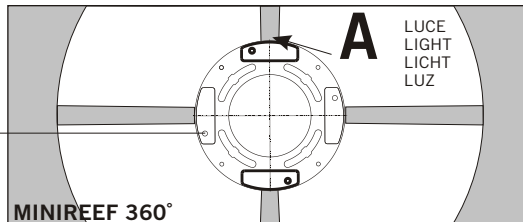
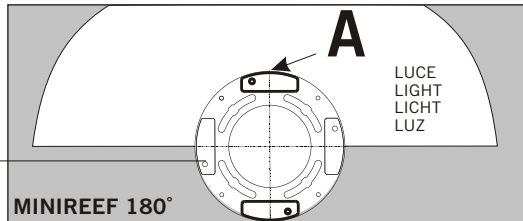
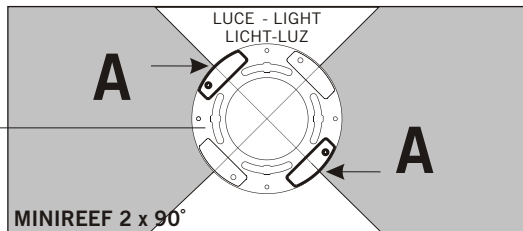
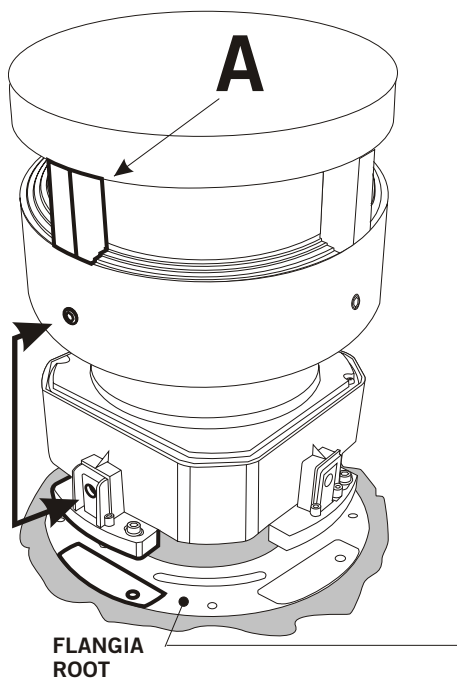

vedere le istruzioni della flangia  
see the instruction of the flange  
voir les instructions dans la bride  
lesen Sie die Anweisungen in den Flansch  
ver la instrucciones de la brida



- I DIRETTIVA 2002/96/CE (Rifiuti di Apparecchiature Elettriche ed Elettroniche - RAEE):  
informazioni agli utenti**  
L'etichetta con il cassonetto barrato presente sul prodotto indica che il prodotto non deve essere smaltito tramite la procedura normale di smaltimento dei rifiuti domestici. Per evitare eventuali danni all'ambiente e alla salute umana separare questo prodotto da altri rifiuti domestici in modo che possa venire riciclato in base alle procedure di rispetto ambientale. Per maggiori dettagli sui centri di raccolta disponibili, contattare l'ufficio governativo locale o il rivenditore del prodotto.
- GB Directive 2002/96/CE (Waste Electrical and Electronic Equipment - WEEE):  
information for users**  
The crossed out wheeled bin label that can be found on your product indicates that this product should not be disposed of via the normal household waste stream. To prevent possible harm to the environment or human health please separate this product from other waste streams to ensure that it can be recycled in an environmentally sound manner. For more details on available collection facilities please contact your local government office or the retailer where you purchased this product.
- D Richtlinie 2002/96/EU (Elektro- und Elektronik- Altgeräte - WEEE):  
Benutzerinformationen**  
Der Aufkleber mit durchgekrenzter Mülltonne an diesem Produkt weist darauf hin, dass dieses Produkt nicht im normalen Hausmüll entsorgt werden darf. Zur Vermeidung einer möglichen Beeinträchtigung der Umwelt oder der menschlichen Gesundheit darf dieses Produkt nicht in den Hausmüll gegeben werden, um zu gewährleisten, dass es in einer umweltverträglichen Weise recycelt wird. Wenden Sie sich für Informationen zu Entsorgungseinrichtungen an die zuständige Behörde oder das Geschäft, in dem Sie dieses Produkt erworben haben.
- F Directive 2002/96/CE (Déchets d'équipements électriques et électroniques - DEEE):  
informations aux utilisateurs**  
L'étiquette apposée sur ce produit et représentant une poubelle à roulettes rayée indique que le produit ne peut être mis au rebut avec les déchets domestiques normaux. Afin d'éviter d'éventuels dommages au niveau de l'environnement ou de la vie humaine, veuillez séparer ce produit des autres déchets de manière à garantir qu'il soit recyclé de manière sûre au niveau environnemental. Pour plus de détails sur les sites de collecte existants, veuillez contacter l'administration locale ou le détaillant auprès duquel vous avez acheté ce produit.
- E Directiva 2002/96/CE (Residuos de aparatos eléctricos y electrónicos - RAEE):  
Información para el usuario**  
La etiqueta de un contenedor tachado que hallará en su producto indica que este producto no se puede tirar con la basura doméstica normal. Para impedir posibles daños medioambientales o para la salud, separe este producto de otros canales de desecho para garantizar que se recicle de una forma segura para el medio ambiente. Para más información sobre las instalaciones de recolección disponibles, diríjase a las autoridades locales o al punto de venta donde adquirió este producto.
- SE Directive 2002/96/CE (Waste Electrical and Electronic Equipment - WEEE):  
information for users**  
Symbolen med en överkorsad soptunna innebär att denna produkt inte får kastas i vanligt hushållsavfall. För att skydda miljön och hälsan bör denna produkt inte kastas tillsammans med vanligt hushållsavfall utan lämnas för återvinning på tillbörligt sätt. För mer information om uppsamlingsplatser, kontakta en lokal myndighet eller den återförsäljare som du köpte produkten från.
- NL Richtlijn 2002/96/EG (Afgedankte Elektrische en Elektronische Apparaten - AEEA):  
informatie voor de gebruikers**  
Op uw product is een label van een rolcontainer met een kruis erdoor aangebracht. Dit wil zeggen dat dit product niet bij het normale huishoudelijk afval mag worden gedaan. Om eventuele schade aan het milieu of de gezondheid van de mens te voorkomen moet dit product gescheiden van al het ander afval worden ingezameld, zodat het op een verantwoorde wijze kan worden verwerkt. Voor meer informatie over uw lokale afvalinzameling wendt u zich tot uw gemeente of de leverancier bij wie u dit product hebt gekocht.
- PL Dyrektywa 2002/96/CE (WEEE - ang. Waste Electrical and Electronic Equipment):  
informacja dla użytkowników**  
Użycie symbolu WEEE oznacza, że niniejszy produkt nie może być traktowany jako odpad domowy. Zapewniając prawidłową użyciową utylizację pomagasz chronić środowisko naturalne. W celu uzyskania bardziej szczegółowych informacji dotyczących recyklingu niniejszego produktu należy skontaktować się z przedstawicielem władz lokalnych, dostawcą usług utylizacji odpadów lub sklepem, gdzie nabyto produkt.
- FI Directive 2002/96/CE (Waste Electrical and Electronic Equipment - WEEE):  
information for users**  
WEEE-merkintä osoittaa, että tätä tuotetta ei voi käsitellä kotitalousjätteen tavoin. Kun huoletdit tämän tuotteen asianmukaisesta hävittämisestä, autat suojelemaan ympäristöä. Lisätietoja tämän tuotteen kierrättämisestä saat paikallisviranomaisilta, jättehuoltoyhtiöltä tai myymälästä, josta osit tämän tuotteen.
- PT Directiva 2002/96/CE (Resíduos de equipamentos eléctricos e electrónicos - REEE):  
informações para os utilizadores**  
A etiqueta com o símbolo de um contentor de lixo barrado com uma cruz que aparece no produto indica que este produto não deve ser deitado fora juntamente com o lixo doméstico. Para evitar possíveis danos no ambiente ou na saúde pública, por favor separe este produto de outros lixos; desta forma, terá a certeza de que pode ser reciclado através de métodos não prejudiciais ao ambiente. Para obter mais informações sobre os locais de recolha de lixo disponíveis, contacte a sua junta de freguesia ou o local onde comprou este produto.



This information only applies to customers in the European Union, according to Directive 2002/96/EC OF THE EUROPEAN PARLIAMENT AND OF THE COUNCIL OF 27 January 2003 on waste electrical and electronic equipment (WEEE) and legislation transposing and implementing it into the various national legal systems.



**SIMES S.p.A. VIA G. PASTORE 2/4 - 25040 CORTE FRANCA (BRESCIA) - ITALY**  
**TEL. +39 0309860430 - FAX +39 0309860439**  
**E-mail: [simes@simes.it](mailto:simes@simes.it) - <http://www.simes.it>**