

MINIBRIQUE STEP RECESSED

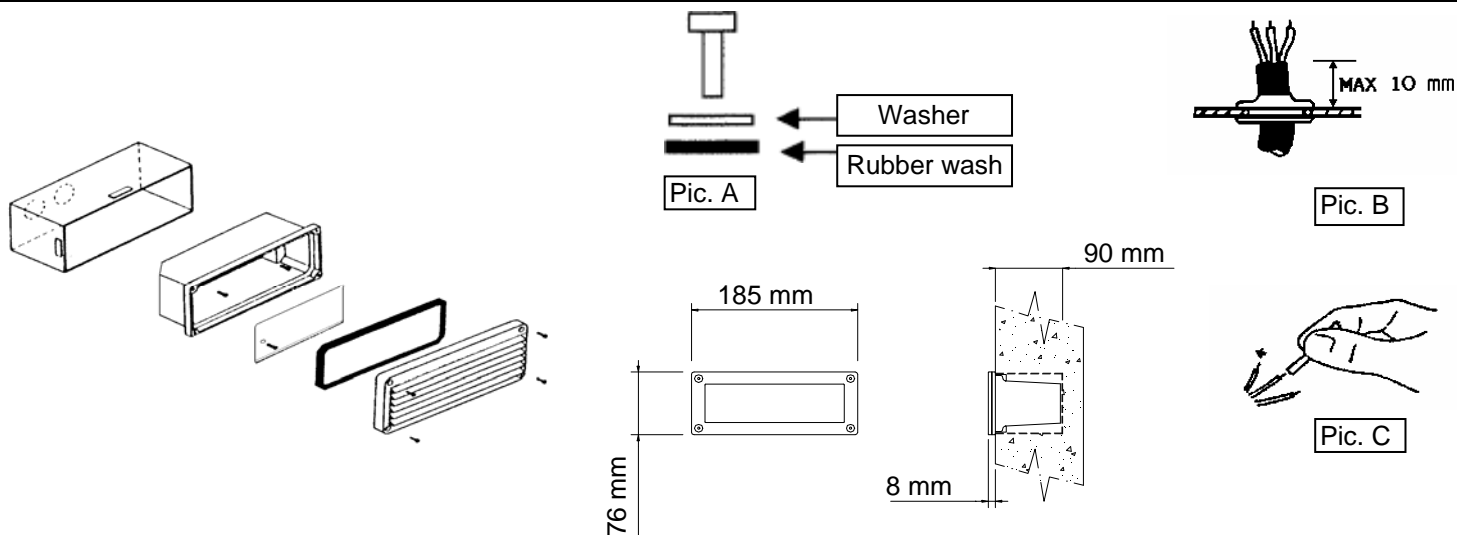

MINIBRIQUE STEP RECESSED

for compact fluorescent lamp 7W G23

with ACCENT LED 4,5W

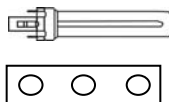

TECHNICAL CHARACTERISTICS:

CLASS I

PROTECTION LEVEL : IP 54

240V 50Hz

ASSEMBLING INSTRUCTIONS:

Open the fitting and remove the reflector

Assembly the rubber gasket and insert the cable D.8-12 mm

Cover the single wires with the supplied silicon sheath (**Pic. C**) and connect them to terminal block.

Fix the fitting to pre-installed recess box with the supplied screws

assembled under the screw head with the metal and rubber washer (**Pic. A**)

Re-assembling the reflector and insert the correct lamp

Close the fitting

NOTES:

Do not exceed the maximum allowed wattage

Disconnect the supply before effecting the maintenance

The fitting must be earthed

Entry with cable for max 10 mm (**Pic. B**)

Use <HAR> type feed cables

For installation use accessory recess-box **ART.S.4553**

Installation should be carried out by a suitably qualified person in accordance with good electrical practice and the appropriate national wiring regulations

The respect of these instructions is very important for the fitting life and for the people safety. Therefore, they must be retained

SIMES

luce per l'architettura

ISTRMINIBRET REV.8 10/12

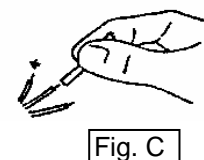
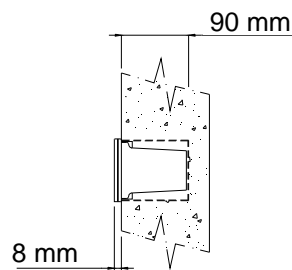
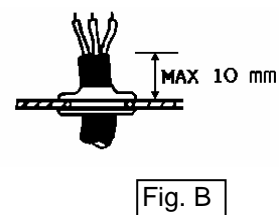
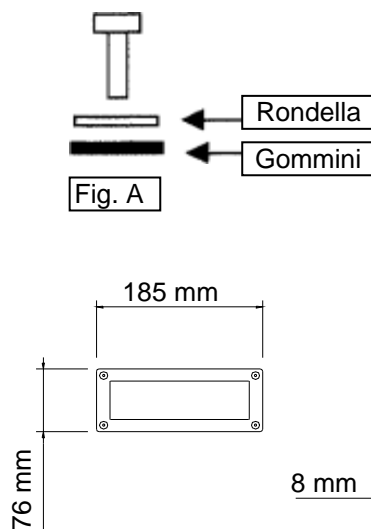
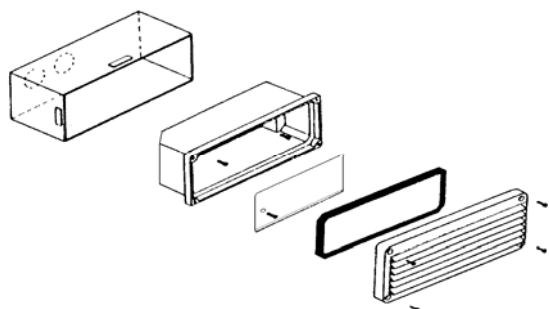

MINIBRIQUE RETTANGOLARE INCASSO

per lampada fluorescente compatta 7W G23

Con ACCENT LED 4,5W

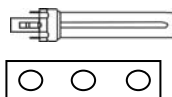

CARATTERISTICHE TECNICHE

CLASSE I

IP 54

240V 50Hz

ISTRUZIONI DI MONTAGGIO

Aprire l'apparecchio e rimuovere il riflettore

Installare il passacavo ed inserire il cavo tripolare D.8-12mm

Ricoprire i cavi singoli con le guaine in dotazione (**Fig. C**) ed effettuare il cablaggio

Fissare l'apparecchio alla cassaforma pre-installata con le viti in dotazione montando

le rondelle ed i gommini sottotesta (**Fig. A**)

Rimontare il riflettore ed inserire la lampada adatta

Chiudere l'apparecchio

NOTE:

Non superare la potenza massima indicata

Togliere tensione prima di effettuare manutenzioni

La presa di terra è obbligatoria

Entrare con il cavo tripolare per max 10mm (**Fig. B**)

Utilizzare cavi di alimentazione di tipo <HAR>

Per l'installazione utilizzare l'apposita cassaforma **ART. S.4553**

L'installazione deve essere eseguita da personale qualificato secondo con le norme di settore .

Il rispetto di queste istruzioni è molto importante per l'efficienza dell'apparecchio e per la sicurezza delle persone, pertanto esse vanno conservate