

TECHNICAL DATA SHEET ART. S.7320N - LOBBY BASIC

Version is available on request

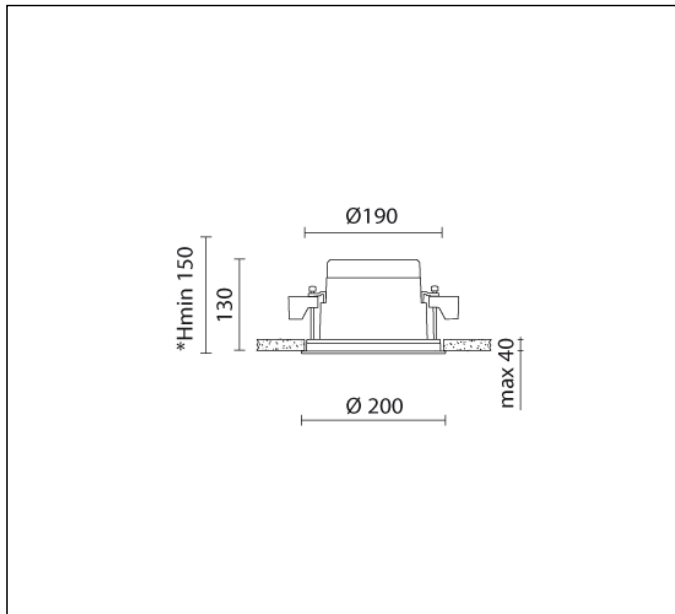

1 MODULES LED COB 4000K 230V 2060lm CRI 83
 Rated luminaire luminous flux: 1672lm
 Rated input power: 18.4W
 Luminaire efficacy: 91lm/W
 Electronic ballast 220÷240V 50/60Hz



* Photometric measured using WHITE LED 3000K



PRODUCT TYPE

False ceiling-recessed down-light fitting. IP rating IP 65

MATERIAL CHARACTERISTICS

Aluminium die cast housing in EN AB-47100 (low copper content) with high resistance against corrosion. Stone wash surface treatment prior to painting process. Aluminium front trim with visible screws for LOBBY BASIC. Marine grade stainless steel AISI 316L front trim with interlocking clips system for LOBBY PROFESSIONAL. A4 grade Stainless Steel screws with 2,5-3% molybdenum content which increases the resistance against corrosion. Pre treated Silicone Gaskets. Painting Process : 3 Step Process

1) Surface treatment with BONDERITE. A heavy metal free chemical surface treatment containing ceramic nano particles giving a cohesive, inorganic and highly dense protective coating. 2) PRE POLYMERIZATION a process of introducing an epoxy primer with excellent characteristics to the paint which also offers very high resistance to oxidation due to its Zinc content. 3) POLYMERIZATION a process with the application of polyester powder with high resistance against UV rays and harsh weather conditions. Resistance test protection for Marine applications for 1200h. Mechanical resistance IK 10

LIGHTING PERFORMANCE

Toughened semiacid-etched glass 10mm thick. Lamp fixed position. LOR --

INSTALLATION AND MAINTENANCE

The luminaires are fixed to the falseceiling by a heavy-duty bracket system, adjustable from inside the luminaire.

WIRING

Luminaire hard wired with 0,50m H05RN-F cable (only for BASIC versions). Isolation: CLASS I . Available colours: Aluminium grey (cod.14). Weight: 2.5 Kg Glow Wire test: --

Lamp included.

LOBBY PATENTED

This luminaire contains built-in LED modules with energy class: A, A+, A++. In case of damage or malfunction please contact the manufacturer to receive additional instructions on how to replace and relative spare parts to order. The LED modules cannot be handled in the luminaire by the end user (Regulation UE 874/2012).

LED circuit boards are engineered accordingly to actual Lumen Maintenance regulation (LM80) and Technical Memorandum (TM21) where uniformity and quality of light is 50.000 hours referred to L70 B20 Ta 25°C.

Lifecycle refers to LED circuit boards only, all others components of the luminaire are excluded.

TECHNICAL DATA SHEET ART. S.7320N - LOBBY BASIC ACCESSORIES



S.7329
HOUSING FOR CONCRETE CEILINGS
Dim. 260 x 260 x 150mm