

## TECHNICAL DATA SHEET ART. S.6618 - MINILOFT WALL

Available until 31/12/2017 but subject to stock levels

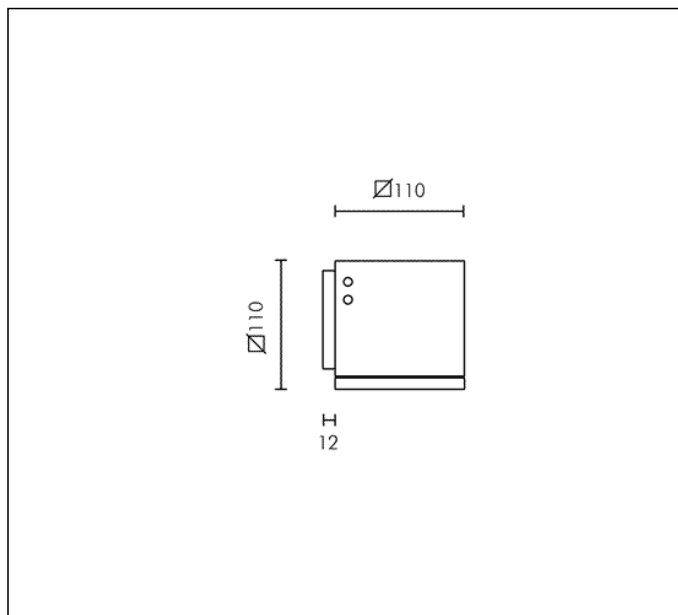
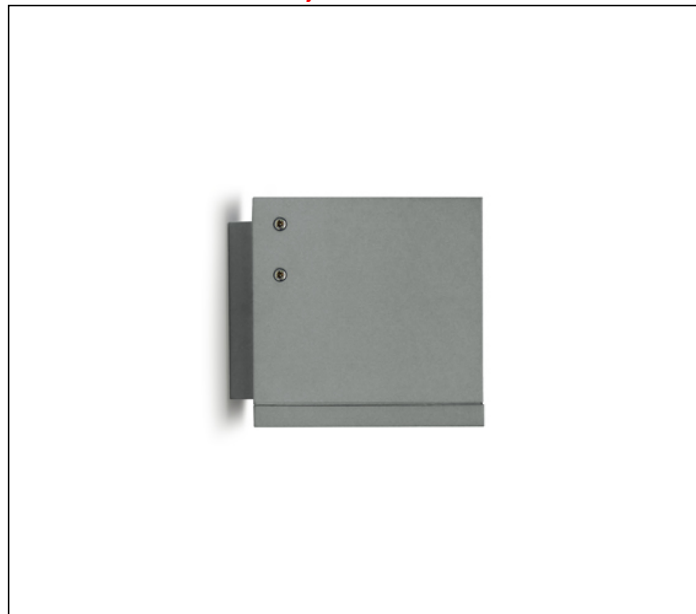

3 MODULES LED 6000K 230V 534lm 4.5W CRI 75

Rated luminaire luminous flux: 411lm

Rated input power: 6W

Luminaire efficacy: 69lm/W

Electronic ballast 220÷240V 0/50/60Hz

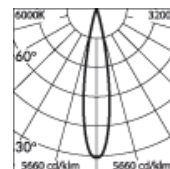
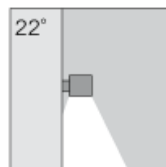

h(m)	22° Ø(m)	6000K E(lx)	3200K E(lx)
1	0.40	2326	1860
2	0.79	581	465
3	1.19	258	207
4	1.58	145	116
5	1.98	93	74



### PRODUCT TYPE

Wall mounted luminaire. IP rating IP 65

### MATERIAL CHARACTERISTICS

Aluminium die cast housing in EN AB-47100 (low copper content) with high resistance against corrosion. Stone wash surface treatment prior to painting process. A4 grade Stainless Steel screws with 2,5-3% molybdenum content which increases the resistance against corrosion. Silicone gaskets. Painting Process : 3 Step Process

1) Surface treatment with BONDERITE. A heavy metal free chemical surface treatment containing ceramic nano particles giving a cohesive, inorganic and highly dense protective coating. 2) PRE POLYMERIZATION a process of introducing an epoxy primer with excellent characteristics to the paint which also offers very high resistance to oxidation due to its Zinc content. 3) POLYMERIZATION a process with the application of polyester powder with high resistance against UV rays and harsh weather conditions. Resistance test protection for Marine applications for 1200h. Mechanical resistance IK 06

### LIGHTING PERFORMANCE

Reflector in 99.98% pure anodized aluminium (with TC and HIT lamp version). Clear toughened glass. LOR --. Lamp adjustable ±15° position.

### INSTALLATION AND MAINTENANCE

For MICROLOFT cable H07RN-F sealed and pre-wired. For MINILOFT and LOFT with the pre-wired connecting wall plaque and its fast connector make the installation and maintenance process quick, easy and safe.

### WIRING

Single cable entry. Isolation: CLASS I. Available colours: White (cod.01), Aluminium grey (cod.14). Weight: 1.3 Kg Glow Wire test: --

L.E.D circuit included.

### LOFT REGISTERED DESIGN

This luminaire contains built-in LED modules with energy class: A, A+, A++. In case of damage or malfunction please contact the manufacturer to receive additional instructions on how to replace and relative spare parts to order. The LED modules cannot be handled in the luminaire by the end user (Regulation UE 874/2012).

LED circuit boards are engineered accordingly to actual Lumen Maintenance regulation (LM80) and Technical Memorandum (TM21) where uniformity and quality of light is 50.000 hours referred to L70 B20 Ta 25°C.

Lifecycle refers to LED circuit boards only, all others components of the luminaire are excluded.

### EMERGENCY VERSIONS

The fittings operates both on AC ( 50/60Hz ) and DC ( 0Hz ) voltage.

## TECHNICAL DATA SHEET ART. S.6618 - MINILOFT WALL ACCESSORIES



**S.6603**

**PIVOTING BRACKET**

Allows to incline by 30° ( not adjustable ).

Available until 31/12/2017 but subject to stock levels

### Further information

#### FIXING BASE

