

TECHNICAL DATA SHEET ART. S.5293 - REEF BOLLARD

Available until 31/12/2017 but subject to stock levels

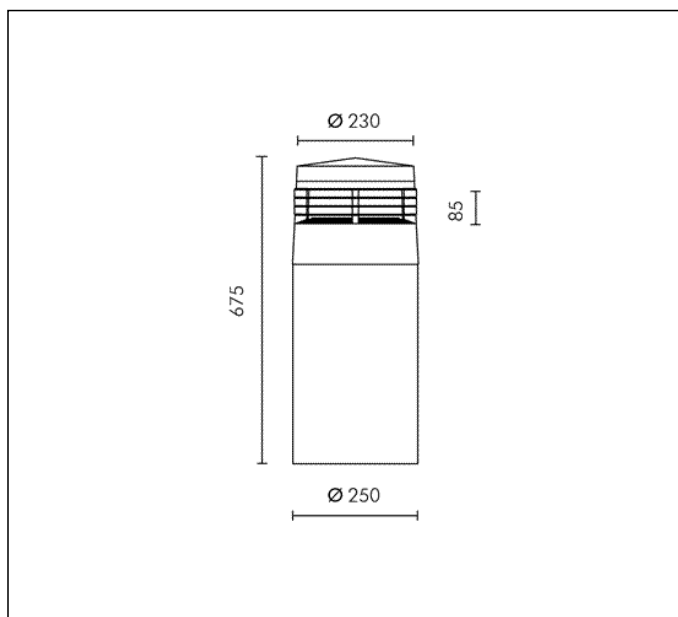

TC-TEL 26W Gx24d-3 1800lm
 Rated luminaire luminous flux: 180lm
 Rated input power: 31W
 Luminaire efficacy: 6lm/W (LOR: 10%)
 Electronic ballast 230÷240V 50Hz

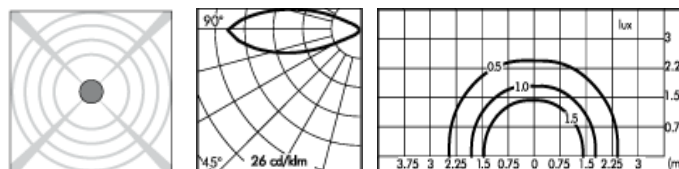

PRODUCT TYPE

Bollard fitting. IP rating IP 65

MATERIAL CHARACTERISTICS

Aluminium die cast housing in EN AB-47100 (low copper content) and extruded EN AW-6060 with high resistance against corrosion. Stone wash surface treatment prior to painting process. A4 grade Stainless Steel screws with 2,5-3% molybdenum content which increases the resistance against corrosion. Pre treated Silicone Gaskets. Painting Process : 3 Step Process

1) Surface treatment with BONDERITE. A heavy metal free chemical surface treatment containing ceramic nano particles giving a cohesive, inorganic and highly dense protective coating. 2) PRE POLYMERIZATION a process of introducing an epoxy primer with excellent characteristics to the paint which also offers very high resistance to oxidation due to its Zinc content. 3) POLYMERIZATION a process with the application of polyester powder with high resistance against UV rays and harsh weather conditions. Resistance test protection for Marine applications for 1200h. Mechanical resistance IK 10

LIGHTING PERFORMANCE

99.98% pure anodized aluminium double reflectors. Polycarbonate lens acid-etched with controlled downward light emission for avoiding any glare, UV-stabilised and vandalproof. Lamp fixed position. LOR 10%

WIRING

Double cable entries with PG16 (Ø 10÷14 mm) cable glands. Isolation: CLASS II. Available colours: Aluminium grey (cod.14). Weight: 12.7 Kg Glow Wire test: 850°C
Lamp included.

This luminaire is compatible with bulbs of the energy classes: B. The luminaire is sold with a bulb of the energy class: B (Regulation UE 874/2012).

EMERGENCY VERSIONS

On request the fittings could be provided with electronic ballast which operate both on AC (50/60Hz), both on DC (0Hz) voltage.

TECHNICAL DATA SHEET ART. S.5293 - REEF BOLLARD ACCESSORIES



S.5203

FLANGE FOR GROUND APPLICATION

Flange \varnothing 250mm h 225mm to be fixed in concrete with stainless steel screws for fixing in the ground.
Footstall dimension can be calculated according to your country norms and ground properties.

Further information

FIXING BASE

