

TECHNICAL DATA SHEET ART. S.5240N - MINIREEF BOLLARD

Version is available on request

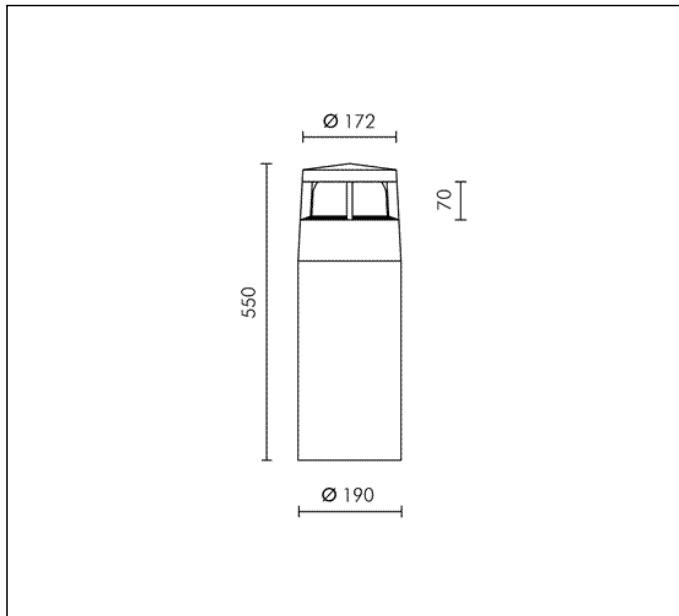

1 MODULES LED COB 4000K 1792lm CRI 90
 Rated luminaire luminous flux: 1123lm
 Rated input power: 18W
 Luminaire efficacy: 62lm/W
 Electronic ballast 220÷240V 50/60Hz

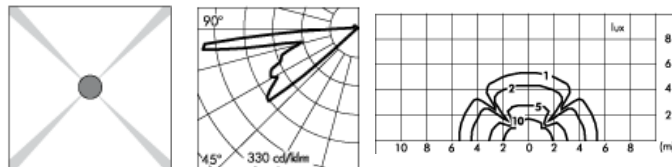

* Photometric measured using WHITE LED 3000K



Fixture available with integral DALI driver on request with surcharge.

PRODUCT TYPE

Bollard fitting. IP rating IP 65

MATERIAL CHARACTERISTICS

Aluminium die cast housing in EN AB-47100 (low copper content) and extruded EN AW-6060 with high resistance against corrosion. Stone wash surface treatment prior to painting process. A4 grade Stainless Steel screws with 2,5-3% molybdenum content which increases the resistance against corrosion. Pre treated Silicone Gaskets. Painting Process : 3 Step Process

1) Surface treatment with BONDERITE. A heavy metal free chemical surface treatment containing ceramic nano particles giving a cohesive, inorganic and highly dense protective coating. 2) PRE POLYMERIZATION a process of introducing an epoxy primer with excellent characteristics to the paint which also offers very high resistance to oxidation due to its Zinc content. 3) POLYMERIZATION a process with the application of polyester powder with high resistance against UV rays and harsh weather conditions. Resistance test protection for Marine applications for 1200h. Mechanical resistance IK 10

LIGHTING PERFORMANCE

99.98% pure anodized aluminium double reflectors. Polycarbonate lens transparent with controlled downward light emission for avoiding any glare, UV-stabilised and vandalproof. Lamp fixed position. LOR -- Compact electronic ballast to guarantee better lamp stability, lifetime and reduced energy consumption (only for HIT-TC CRI 20W and LED).

WIRING

Double cable entries with grommets (Ø 7÷13 mm). Isolation: CLASS II. Available colours: Aluminium grey (cod.14). Weight: 6.2 Kg Glow Wire test: 850°C

Lamp included.

This luminaire contains built-in LED modules with energy class: A, A+, A++. In case of damage or malfunction please contact the manufacturer to receive additional instructions on how to replace and relative spare parts to order. The LED modules cannot be handled in the luminaire by the end user (Regulation UE 874/2012).

LED circuit boards are engineered accordingly to actual Lumen Maintenance regulation (LM80) and Technical Memorandum (TM21) where uniformity and quality of light is 50.000 hours referred to L70 B20 Ta 25°C.

Lifecycle refers to LED circuit boards only, all others components of the luminaire are excluded.

EMERGENCY VERSIONS

The fittings operates both on AC (50/60Hz) and DC (0Hz) voltage.

TECHNICAL DATA SHEET ART. S.5240N - MINIREEF BOLLARD ACCESSORIES



S.5200

FLANGE FOR GROUND APPLICATION

Flange \varnothing 190mm h 225mm to be fixed in concrete with stainless steel screws for fixing in the ground.
Footstall dimension can be calculated according to your country norms and ground properties.

Further information

FIXING BASE

